

IMPORTANT – Please read these instructions carefully before assembling

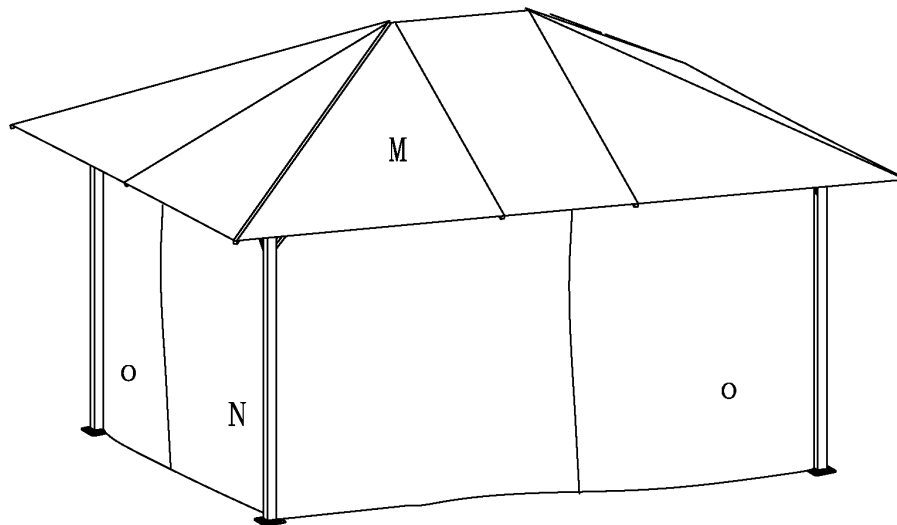









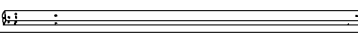
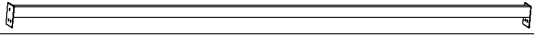
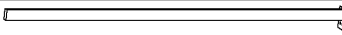
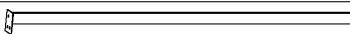











GL1152 Venice gazebo 3x4m Assembly Instructions



WE RECOMMEND 2 PEOPLE TO ASSEMBLE THIS GAZEBO

If you need help with assembly or missing parts please call our customer care team on: 0121 616 1939

Please check if you have all the parts as listed **Note:** The quantities below are the correct amount to complete the assembly. In some cases more fittings may be supplied than are required.

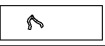
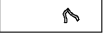
KWSP3614E 3X4M		
Part#	Image	Qty
1		4
2		2
3		2
4		2
5		8
7		4
8		4
10		4
11		4
12		4
13		2
14		10
15		2
16		1
17		6
F		8
G		8
H ₁	 M6*15	66
H ₂	 M6*30	10
H ₃	 M6*40	16
I		10
J		8
K		2
L		1
M		1
N		2
O		2

Dimensions EXTERNAL	
Width	300 cm
Depth	400 cm
Height	260 cm

Assembly Requirements	
Number of people required to assemble	2
Approximate assembly time	45-1 Hour

If you need help with assembly or missing parts please call our customer care team on: 0121 616 1939

Assembly Instructions

Step 1 & 2

Connect the upright leg (1)
With the foot plate part (10)

Add clip (14) to the top of the
leg and to all the pre-drilled
legs as shown

Do not over tighten the
screws at this stage

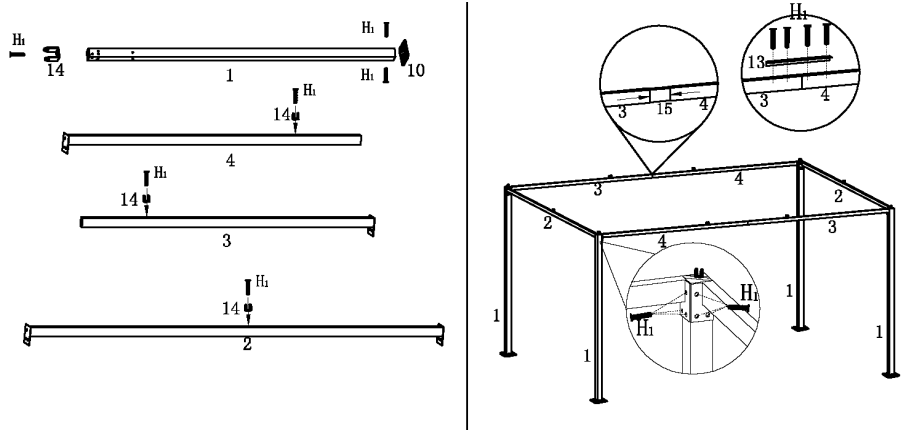

Step 3 & 4

Add the cross supporting
members by connecting
using inserts G & F

Add the supporting side parts
(5)

And add the curtain tracking
bar to the inside of the frame

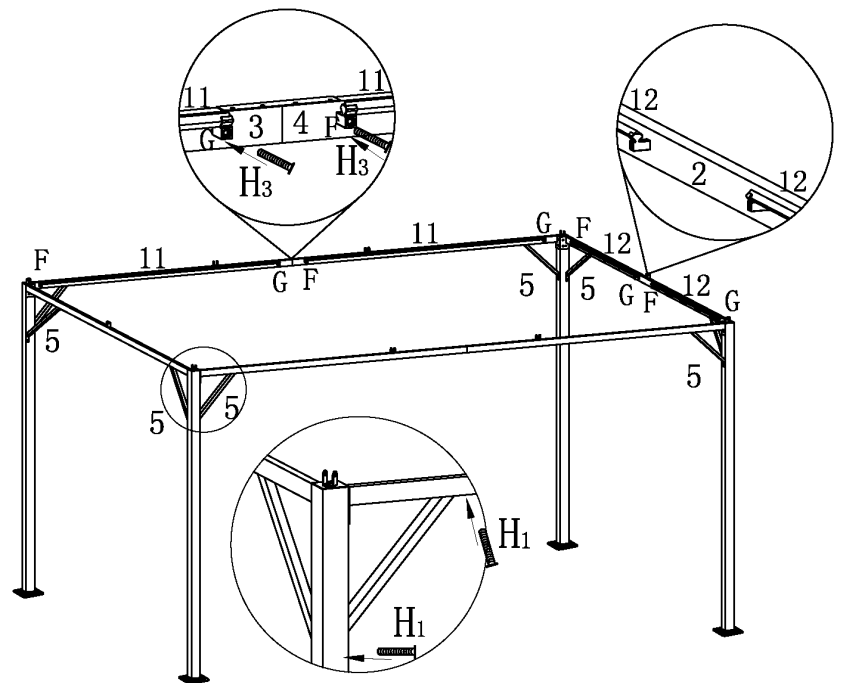

If you need help with assembly or missing parts please call our customer care team on: 0121 619 1939

Step 5

Now make the spider roof support frame part (16)

Connecting all the roof poles ensuring the corner poles Part 8 are positioned to attach the frame into the corner.

Simply slot these in and then lift the poles onto the frame

Secure the frame with bolt H2

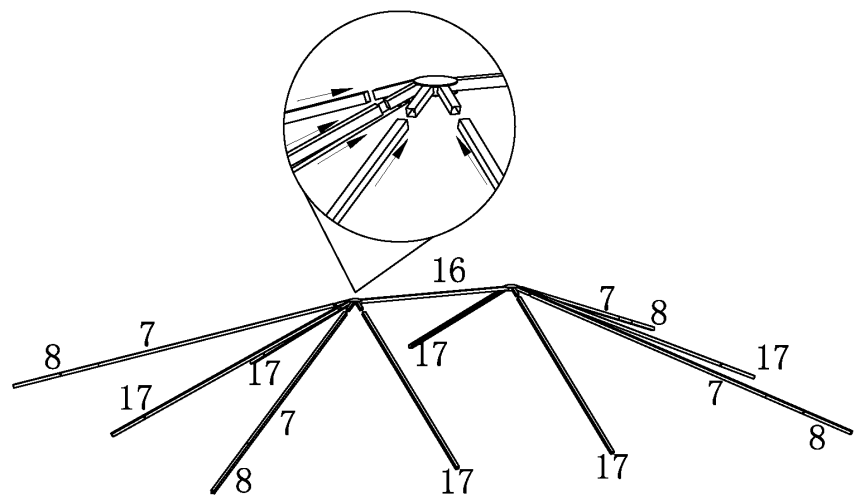

Step 6

The Venice gazebo is now ready to add the roof and curtains. First apply the roof canopy (M) simply throw the roof over the top section and spread it out so that all the corners are close to the roof bars. The easiest way to secure the roof is to pull the canopy over using the elasticated ends and secure the mid sections first, always making sure the canopy is even across the roof leaving the 4 corners until last. For the curtains undo each section (as they are all zipped together and from the internal (inside) one curtain fits every corner across one leg so when zipped it will all join up.

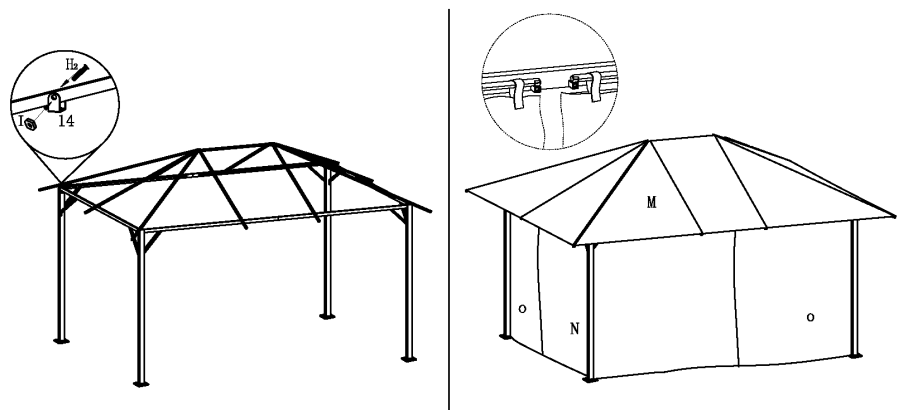

If you need help with assembly or missing parts please call our customer care team on: 0121 616 1939

Safety and Care Advice

Distributed by:

Glendale Leisure
46 Barn Street, Digbeth
Birmingham B5 5QB

www.Glendale-leisure.com

If you need help with assembly or missing parts please call our customer care team on: 0121 616 1939

Your Gazebo frame can be left outside all year round but we advise the curtains & Canopy are taken off during the winter months and stored in a cool dry frost free place (do not store wet). This will prevent them from deteriorating. (To keep the canopy refreshed use a water proofing spray on the outside of the roof & curtains at least 3 times a year) Available at all good tent/camping shops.

***VERY IMPORTANT YOU MUST SECURE YOUR GAZEBO TO THE GROUND AS SOON AS IT IS BUILT – in heavy winds remove the canopy to avoid wind damage – Do Not BBQ under this gazebo**

To secure to grass use the tent pegs provided for hard surface patios fixing bolts must be used.