

# Venetian Corner Arbour

IMPORTANT, RETAIN FOR FUTURE REFERENCE;  
READ CAREFULLY

- Always pre-drill the timber to avoid splitting.
- The timber in this product is pressure treated to ensure longevity and protection against rot. This may leave colour variations, but these will even out as the moisture content stabilises
- Timber is a natural material and will shrink and swell as a result of varying moisture content.
- Please keep all plastic bags and small parts away from children
- **Warning. Only for domestic use**
- This product must be built on a solid level base.

Technical Help line: **0333 7777 089** 8.30 am and 5.00 pm Monday to Friday.

In line with your statutory rights, please check all parts prior to assembly, as assembly of damaged parts may be deemed to be acceptance and this may affect the remedies you are entitled to. If the product is not constructed in accordance with the instructions, or is altered in anyway (e.g. painted), the manufacturer cannot be held liable for any resulting damage.

## Fixing Pack (ACARBFP)

Not to Scale

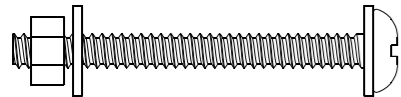

M8 x 70mm COACH BOLT Qty 2  
M8 x 70mm NUT Qty 2  
M8 Washer Qty 2



60mm SCREW Qty 8

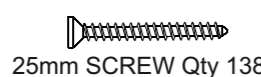

25mm SCREW Qty 138



70mm SCREW Qty 36

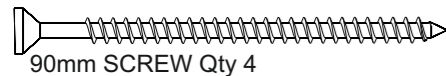

90mm SCREW Qty 4



100mm SCREW Qty 4

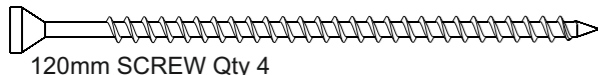

120mm SCREW Qty 4



DRILL



TAPE MEASURE



SPIRIT LEVEL



POZI DRIVE SCREWDRIVER



HAMMER

Important :  
Assembly of this  
arbour requires a  
minimum of two  
adults.



**MUST PRE DRILL**

## CARB PARTS LIST

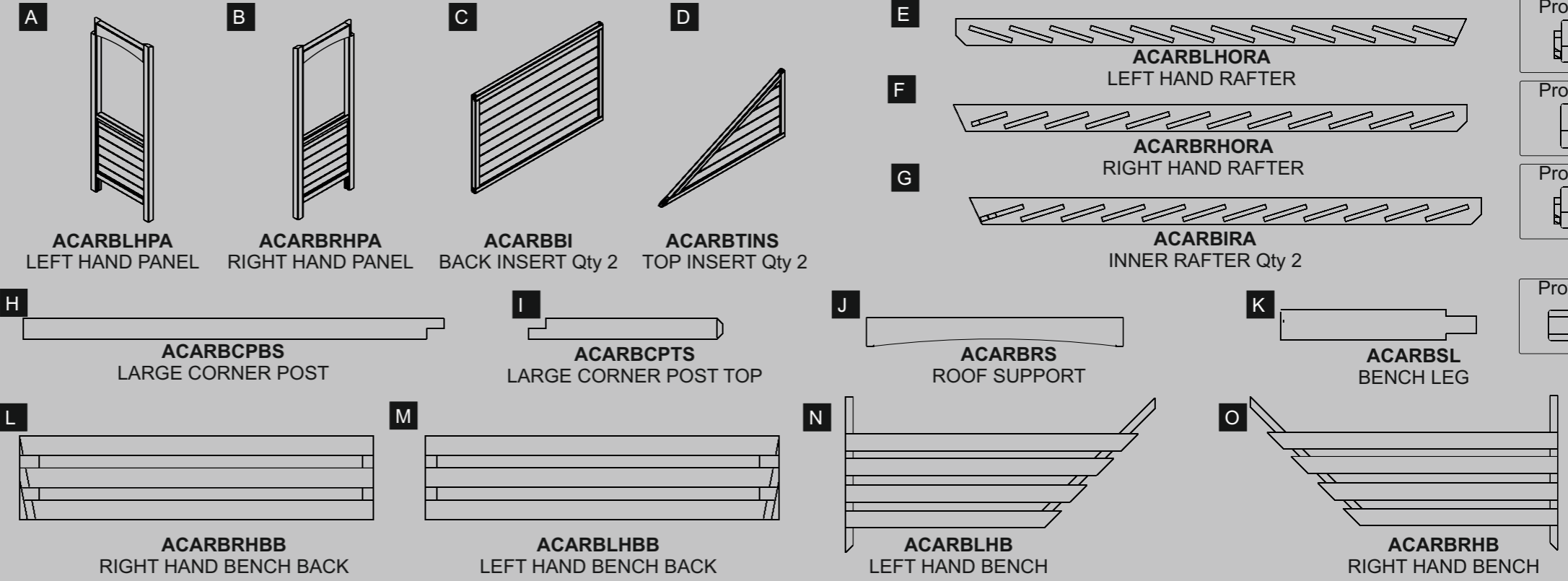

Issue 0214

Profile



Profile



Profile



Profile



## ROOF PACK



1

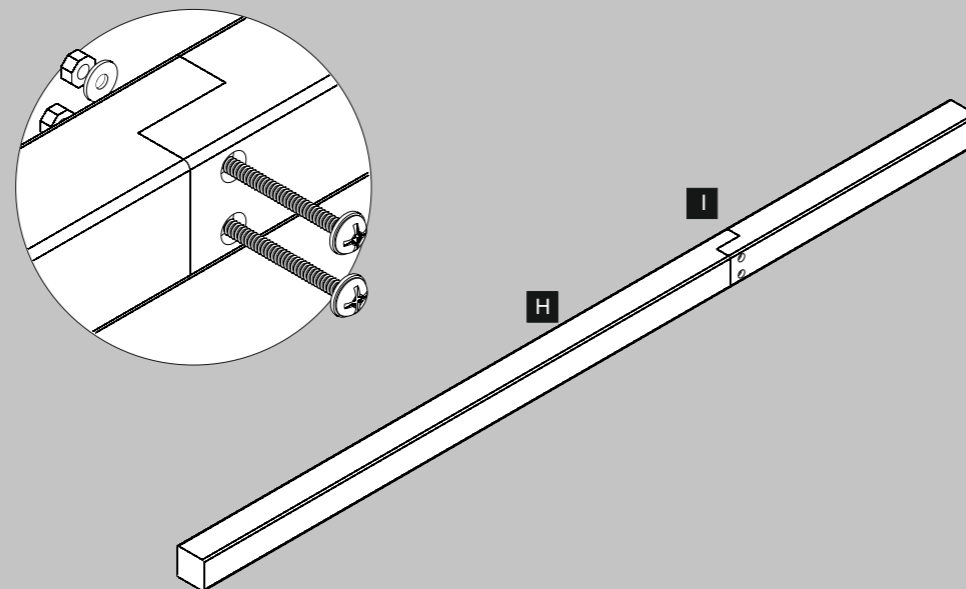

Slot the two posts together and fix using the two coach bolts.

2

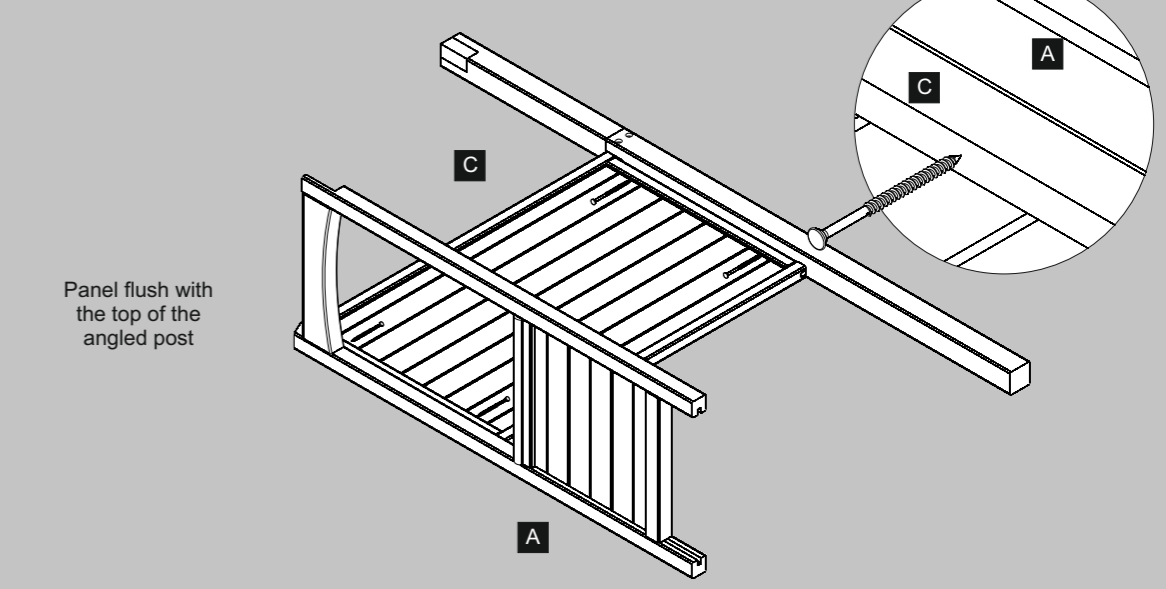

Fix the back insert to the left hand panel using 2 x 70mm screws, screwing through the back insert's framework into the post. (Make sure the insert is inline with the back and top of the left hand panel.)

Place the assembled post against the back insert and fix the insert to the post using 2 x 70mm screws.

(USE A TAPE MEASURE TO MAKE SURE THE POST IS IN LINE WITH THE BOTTOM OF THE SIDE PANEL.)

3

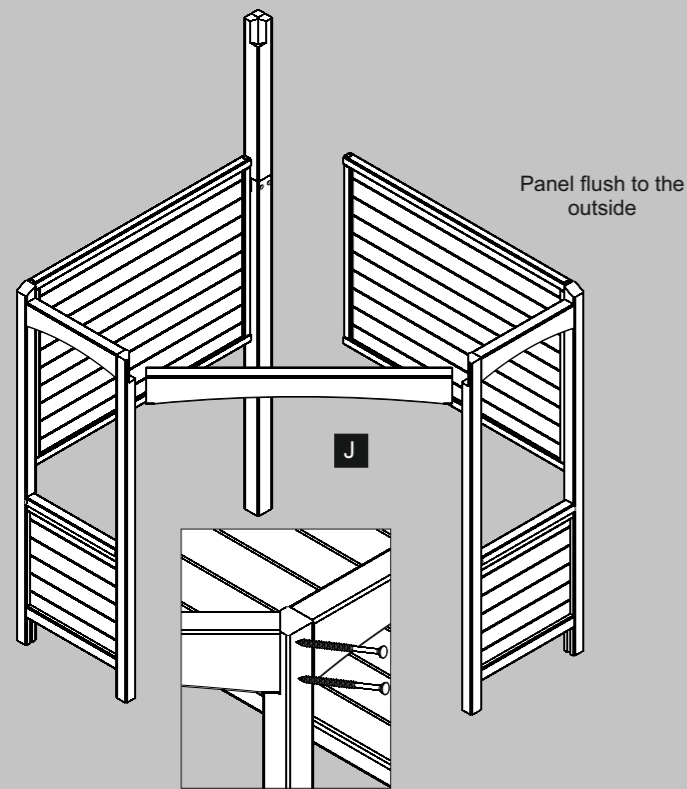

Repeat step 2 for the right hand panel.

Stand the assemblies up and position the completed right hand side against the left. Fix the right hand panel to the post using 2x70mm screws, screwing through the framing into the post.

Fit the arched roof support so that it slots in to the notches on both panels. Fix this in place by screwing through the post into the end of the support using 2 x 70mm screws for each end.

4

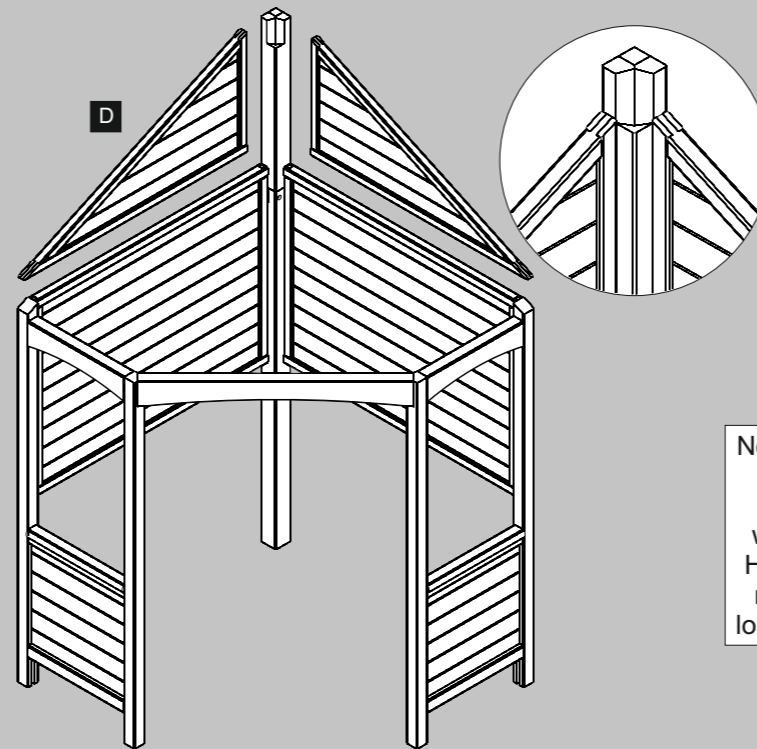

Place a top insert on to the back insert. Make sure that these are both in line before fixing the top insert to the post using 2 x 70mm screws screwing through the framework into the post.

Further secure the top insert by screwing up through the back insert's framework into the top insert using 2 x 60mm screws.

5

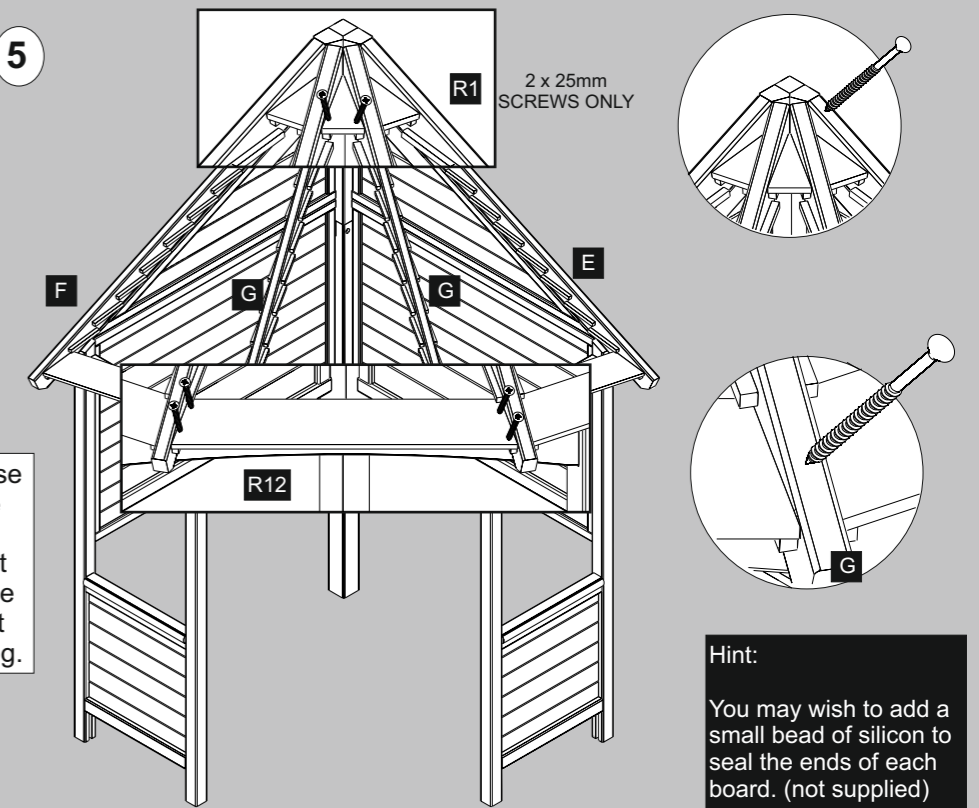

Note: Please take care when working at Height. The roof is not load bearing.

Hint:  
You may wish to add a small bead of silicon to seal the ends of each board. (not supplied)

Fix the rafters to the post using a 90mm screw for each. (Only partially fix the screw to allow movement of the rafters)

Using the smallest and largest roof boards positioned at the top and bottom, adjust the rafters so that all the boards sit flush. Once flush fully secure the rafters. Fix the bottom of the rafters to the assembly using a 120mm screw for each.

Fix all of the boards to the rafters using 4 x 25mm screws for each board but only 2 x 25mm screws for the smallest boards at the top.

6

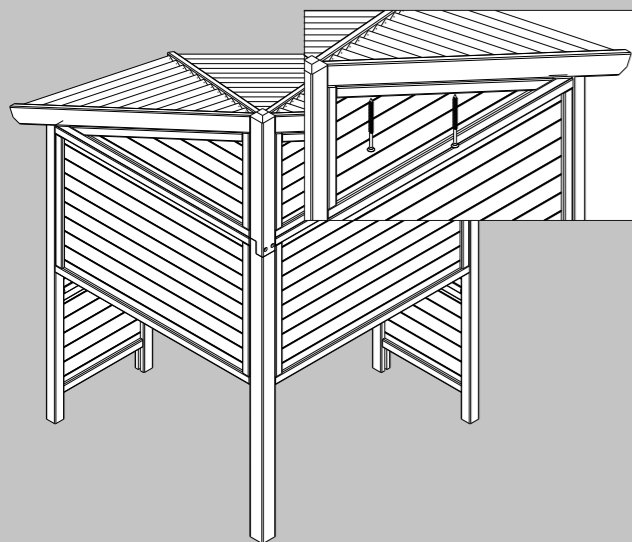

Fix the top insert to the rafters using 2 x 70mm screws for each screwing from underneath as illustrated.

7

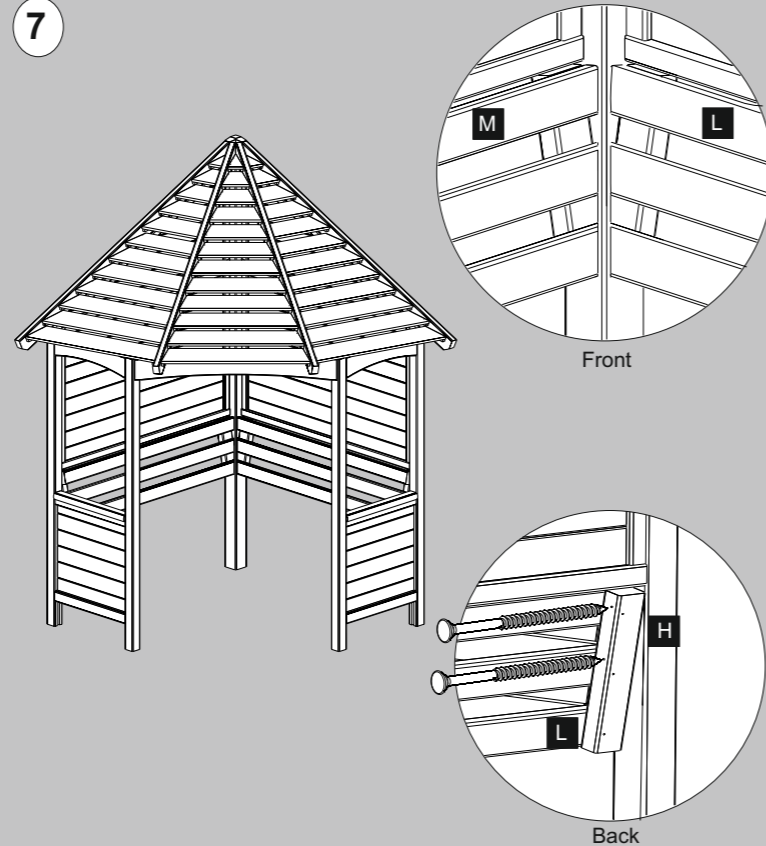

Position the bench backs so that they fit between the panels and post and they are pushed up tightly against the back insert.

Fix each bench back in place using 2 x 100mm screws to fasten the bench to the post and 2 x 70mm screws through opposite batten into the panel.

8

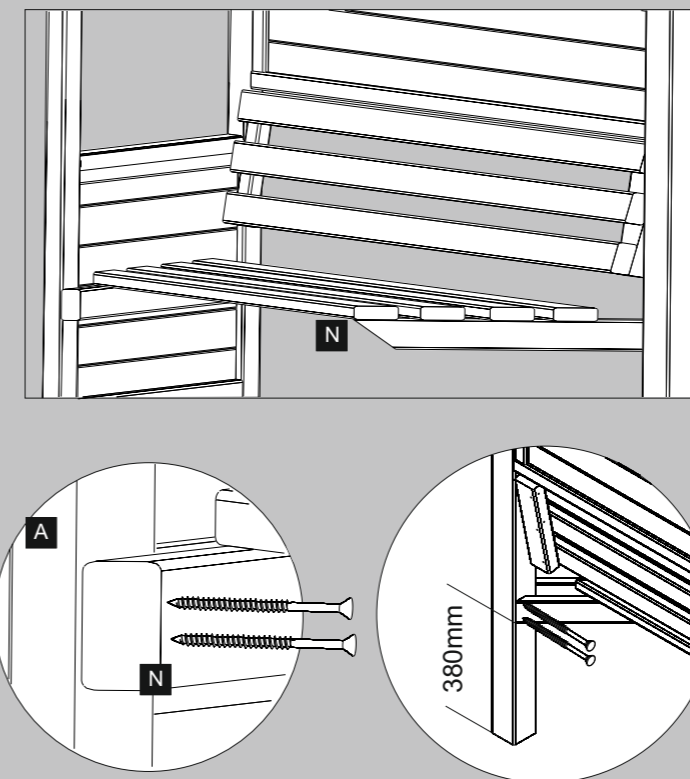

Place the left hand bench into the arbour so the bottom of the bench is 380mm from the floor.

Fix the bench to the left hand panel using 2 x 70mm screws for both the front and back ends of the bench frame. Make sure that the screws locate into the vertical posts of the side panel.

Fix the other end of the bench to the back post using another 2 x 70mm screws.

9

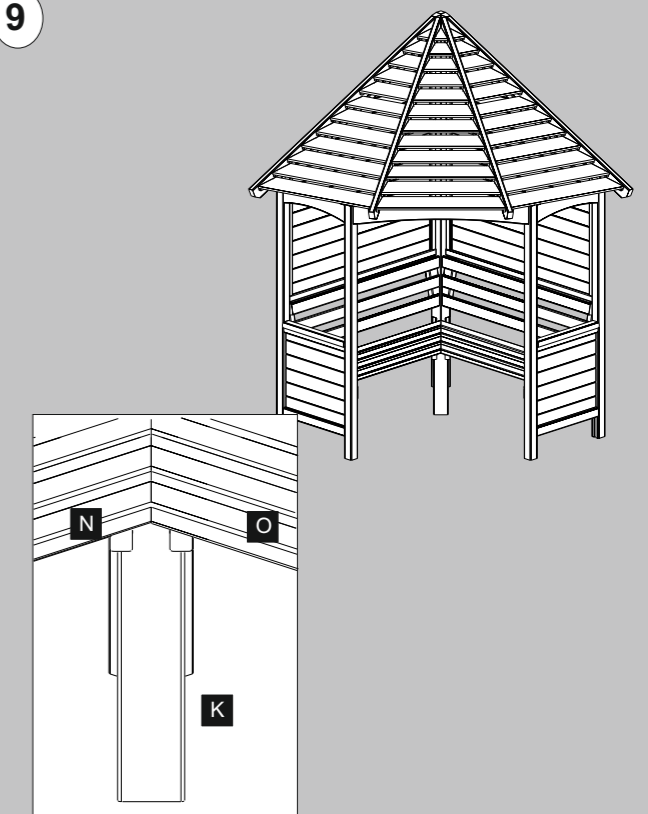

Place the bench leg so that it fits in between the two bench sections.

Fix the bench sections to the leg using 2 x 60mm screws for each.