

IMPORTANT, RETAIN FOR FUTURE REFERENCE: READ CAREFULLY.

ISSUE 0310

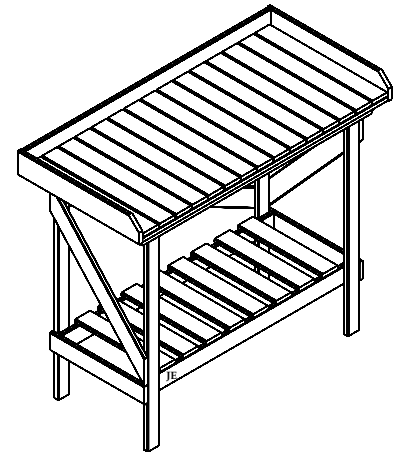
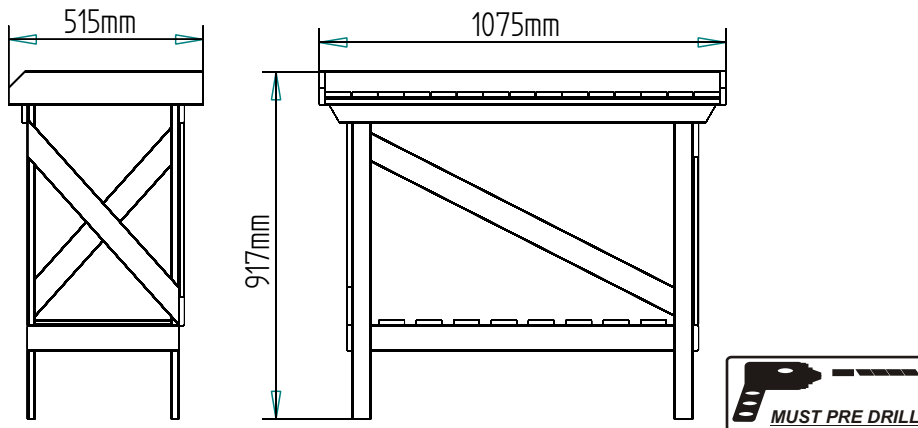

Thank you for choosing this garden product manufactured by the UK's largest manufacturer of timber garden products. In order to gain the most benefit from it, please note the following:

- If there are any technical queries with the product, please contact our customer help line on 0844 248 9853 between the hours of 8.30 am and 5.00 pm Monday to Friday.
- Please ensure that you thoroughly check all component parts for quantity and quality before you commence building the product. If there are any missing parts, please contact the help line as shown immediately. The manufacturer cannot be held liable for damaged items once any part of the product has been fitted or altered in any way (e.g. Painted)
- This product is pressure treated to ensure longevity of all timber components and protect against rot. This may leave a colour difference on some parts that will even out as the moisture content stabilises.
- Timber is a natural material. It will shrink and swell as a result of varying moisture content.
- Please keep all plastic bags and small parts away from children in order to reduce the risk of suffocation.

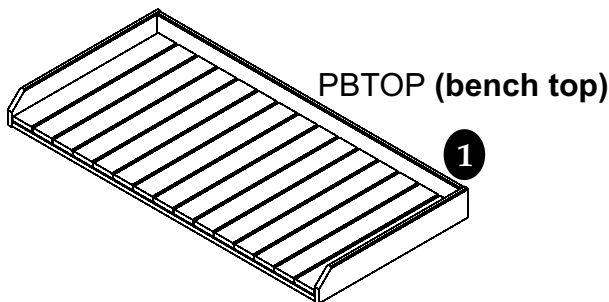

PBTOP (bench top)

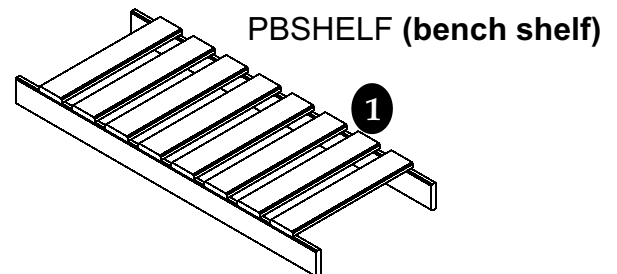

PBSHELF (bench shelf)

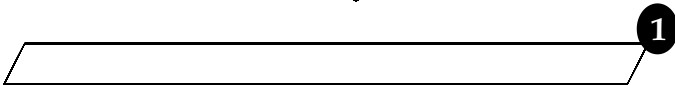

681501044A2PTR (back brace)



68150633A2PTR (angled brace)

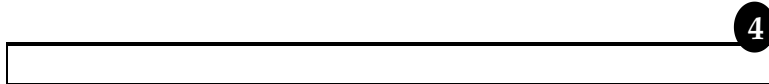

49200850PTR (bench leg)

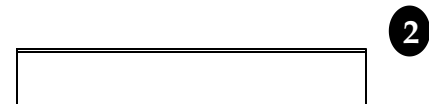

68150400PTR (bench leg brace)



68151045A1PTR (bench rail)

REQUIRED TOOLS : (NOT SUPPLIED)

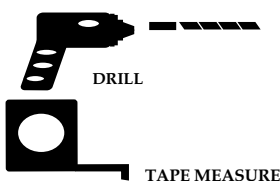

DRILL

TAPE MEASURE

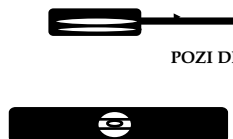

POZI DRIVE SCREWDRIVER

SPIRIT LEVEL

PBFP : (FIXING PACK)

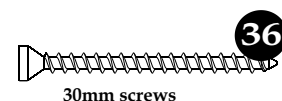

30mm screws



40mm screws

1

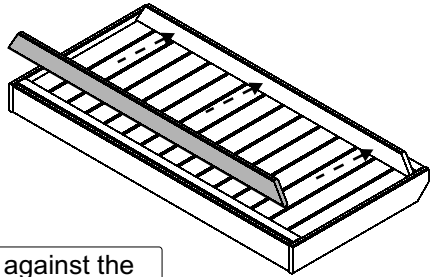
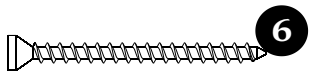

Place the **bench rail** against the batten on the underside of the bench top. Secure in place using 3 x 40mm screws for each.

2

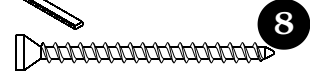
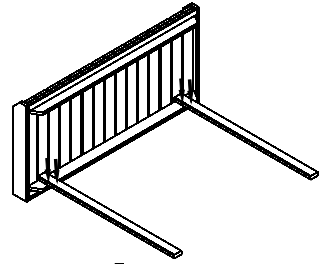

Place the potting **bench top** on its back and place two of the legs 800mm apart making sure there is equal spacing on either side. Fix in place by using 2x30mm screws for each leg, screwing into the bench rail on the underside of the bench top.

Turn the assembly over and repeat the step

3

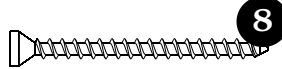
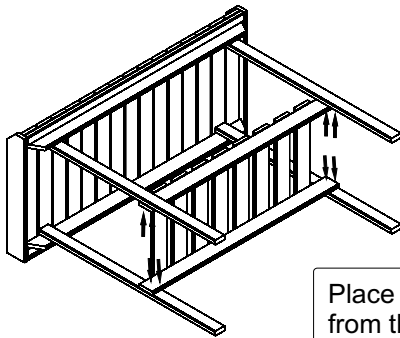

Place the **shelf** inside the legs and 180mm from the base as shown. Secure the shelf in position, screwing from the inside using 2x30mm screws for each leg.

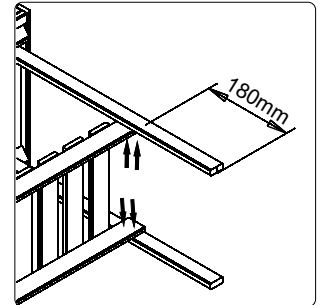

4

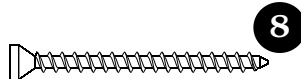
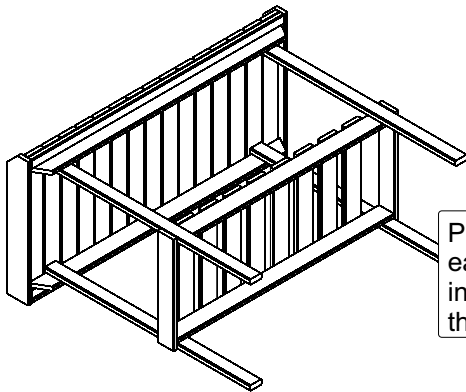

Place the **bench leg braces** across each end of the assembly so they are in line with the shelf. Fix the brace to the posts using 2x30mm for each post.

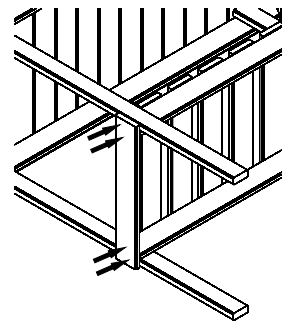

5

Place both of the **angled braces** on either side of the potting bench as shown. Make sure they are flush with the outside of the legs. Secure using 2x30mm for each end.

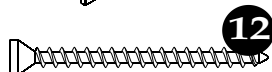
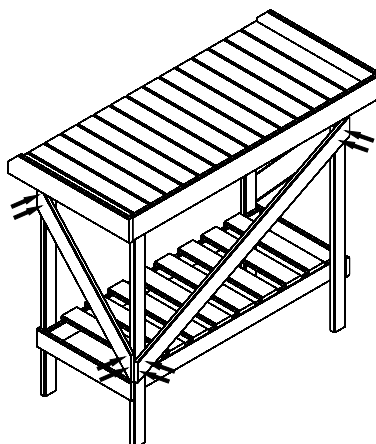

Place the **back brace** on the back of the potting table in the same manner you have just done for the small braces. Use 2x30mm screws for each end.