

Power

Pent Bike Shed Instruction Manual

Size 6

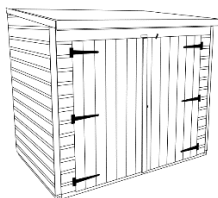

WARNING

UNPACKING SAFELY

Please follow these instructions to unpack your garden building safely



- Two people minimum to unpack
- Place the pallet on firm level ground
- Cut the plastic banding
- Remove each panel by removing screws one column at a time as indicated below
- Be careful of loose components inside the pack when removing panels
- Check all the components against the checklist prior to install

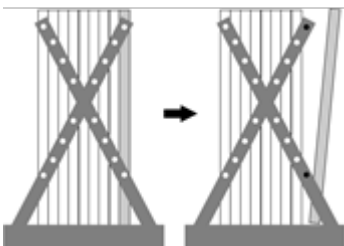

BASE KIT AND FIXING PACK

Please note – if you have ordered a base kit it's unlikely you will be able to see the base kit from the outside of the pack - it will be inside your panels. The fixings are also inside the pack.

Power

Power Pent Bike Shed Product Instructions

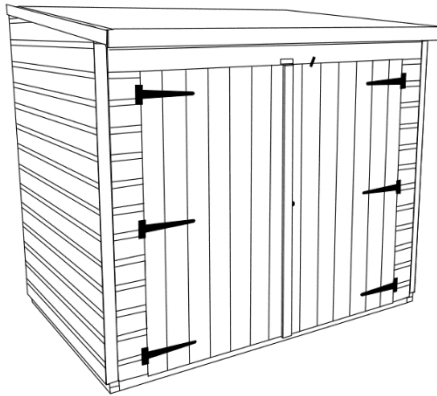

(Please note – this image is for illustration purposes only. The shed you ordered may be a different size or roof sloping other way)

Watch the video!

We recommend watching our installation video before starting assembly of your Power shed.
This video can be applied to all pent sheds in our range



www.Powersheds.com/faqs/how-do-you-assemble-a-power-shed/

Contents

Page 3 – Before You Start

Page 4 – Timber & Base Details

Page 5 – Components Checklist

Page 6 – Pre-Assembly

Page 7 – Floor

Page 8 - 11 – Walls

Page 12 – Front Top & Gable

Page 13 – Roof

Page 14 – Doors

Page 15 – Felt

Page 16 – Finishing Touches

Page 17 – Aftercare & Maintenance

Page 18 – Shed Shelving Instructions

Before You Start

Most accidents are the result of negligence and carelessness, usually caused by the failure of the operator to follow simple but necessary safety precautions.

Do **not** install the garden building before carefully reading this manual.

Visit www.Powersheds.com to check the base size for your shed and any other dimensions you may need.

Health & Safety

Every effort has been made during the manufacturing process to eliminate splinters on the timber.

You are strongly advised to wear gloves when working with or handling timber.

We also strongly advise you to wear safety glasses when installing the felt to protect your eyes.



2 persons recommended



Power Sheds Ltd cannot be held responsible for any damage or injury sustained due to incorrect unloading, unpacking, or assembly of any of our products.

Tools Required

(not supplied)



Drill



Spirit level



Hammer



Stanley knife



Stepladder



Saw

Our Treatment

Wear gloves when handling freshly treated wood.

Avoid breathing dust when cutting treated or untreated wood. Dispose of off-cuts responsibly – do not burn.

Contains: IPBC (3-iodo-2-propynyl-N-butyl carbamate) and propiconazole.

May produce an allergic reaction (EUH208). Causes serious eye irritation (H319) Wash skin thoroughly after handling (P264) Wear protective gloves/protective clothing/eye protection/face protection (P280)

IF IN EYES: Rinse continuously with water for several minutes.

Remove contact lenses, if present and easy to do and continue rinsing. (P305 + P351 + P338)

If eye irritation persists: Seek medical advice/attention (P337+P313)

Timber

As timber is a natural product, it is prone to changes in appearance, including but not limited to movement, warping and splitting, particularly in extreme weather conditions. There may be the occasional split, knot or similar visual imperfections in the timber.

Whilst every effort is made to hand pick timber without visible knotholes or splits there may be occasions where timber is selected in good faith that contains what appears to be a solid knot. Over the course of time/during movement of the product, it may be that these small knot holes are then dislodged from the timber leaving a small knot or crack.

Unfortunately, we cannot be held responsible for this maturing of the product and can only offer our best advice as to how to deal with this situation in the unlikely event that it should occur. Our advice would be to apply some wood filler to the area affected or in extreme circumstances to change the board over.

None of this should affect the structural integrity of the product.

Firm & Level Base

All our garden sheds require a firm and level base.

When thinking about where the garden building and base is going to be constructed:

- Ensure that there will be access to all sides for maintenance work and annual treatment.
- Remember not to place the base too close to any walls or fences, as there may be a slight overhang on the roof which may come into contact with the wall or fence.
- Ensure the base is level and is built on firm ground, to prevent distortion.
- Refer to PowerSheds.com for base dimensions.
- Consider when placing the base next to trees or large bushes as this could cause problems from overhanging branches. If these are likely to grow and come into contact with the building in the future this could cause the felt to rip.

The base is slightly smaller than the external measurement of the building, i.e. The cladding should overhang the base, creating a run for water.

It is recommended that the floor is at least 25mm above the surrounding ground level to avoid flooding.

If you have not chosen to purchase our Power Base, then other suitable bases would include a concrete base (75mm of concrete on top of 75mm of hardcore) or a paving slab base (slabs laid on top of 50mm of sharp sand).

Power Base Kit



If you have ordered a Power Base Kit the instructions can be found in the small base kit fixing pack. Please scan the QR code to watch our base kit installation video -

Watch the build a base video:



Component Checklist

	2x6 Floor Panel	3x6 Floor Panel	4x6 Floor Panel	2x2 Floor Panel	6x2 Roof Panel (1790 x 700)	6x3 Roof Panel (1790 x 990)	4x4 Roof Panel (1290 x 1190)	2x4 Roof Panel (1290 x 600)	4x5 Roof Panel (1590 x 1190)	2x5 Roof Panel (1590 x 600)	4x6 Roof Panel (1890 x 1190)
6x2	1	0	0	0	1	0	0	0	0	0	0
6x3	0	1	0	0	0	1	0	0	0	0	0
6x4	0	0	1	0	0	0	1	1	0	0	0
6x5	1	1	0	0	0	0	0	0	1	1	0
6x6	1	0	1	0	0	0	0	0	0	0	1

	6ft Pent Top	4ft Pent Top	2ft Pent Top	2ft Bargeboard	2ft Bargeboard	3ft Bargeboard	4ft Bargeboard	5ft Bargeboard	6ft Bargeboard	Cover Lat (1595 x 58mm)	Felt	Fixing Pack
6x2	1	0	0	2	0	0	0	0	3	5		
6x3	1	0	0	0	2	0	0	0	3	5	(1x)6ft Piece @ 1m wide	1
6x4	1	0	0	0	0	0	2	0	3	5	(1x)6ft Piece @ 0.5m wide (2x)6ft Piece @ 1m wide	1
6x5	1	0	0	0	0	0	0	2	3	7	(2x)6ft Piece @ 1m wide (1x)6ft Piece @ 0.5m wide	1
6x6	1	0	0	0	0	0	0	0	5	7	(1x)6ft Piece @ 1m wide	1

The Fixing Pack

Your fixing pack will include:

- 25mm screws
- 35mm screws
- 50mm screws
- 70mm screws
- Clout nails (for the felt)
- Door handle
- Turn buttons

If you have ordered a Power Base, you will also receive 80mm and 100mm screws.

On the rare occasion that not enough screws are provided please contact us to make us aware so we can send more out to yourself. Please be aware we are unable to reimburse if you purchase your own.

Pre-Assembly

1. Safely unpack your components and check that you have all the parts required.
Please use the table in the two previous pages to view which components are required for the size you have ordered.
2. Carefully remove the pallet and any untreated packing timber.
See the aftercare section on ways to recycle these items or alternatively you can discard them.
3. Remove any transport blocks from the bottom of the blank and window panels. These are there to offer further protection to the bottom board of the panel.

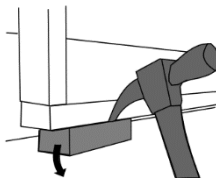

USEFUL TIP!

Re-treat the underside of the floor before assembly for additional protection and maximum longevity.

Drilling

In the instructions we will talk about screwing panels together.

We recommend that this is done with a drill as will minimise the chance that the timber will split.

We suggest that you pre-drill the timber with a 3mm drill bit before inserting the screws.

Floor

1. Lay down your floor panel(s) onto your firm and level base into the desired position of your shed. Be sure to consider any overhangs on the shed when deciding the correct position as per the instructions regarding bases in the 'before you start' section. You will also need to ensure you leave sufficient space around the building to be able to fix the cover lats, apply the felt and give the building it's annual treatment.

**NOTE: Do not confuse floor panels with roof panels.
Floor panels will have more pieces of framing attached.**

2. For the 6x5 and 6x6 sizes, the floor will be in two sections. Turn the floor sections upside down so that the floor bearers are facing up. Join the floor panels together using the 50mm screws provided. You can then turn the floor back the right way to create the full floor. For 6x2, 6x3 and 6x4 sheds, the floor panel is in one piece.
3. Screw the two 'heavy duty bearers' which are two pieces of framing joined together, to the two ends of the shed with 70mm screws. This will cover the ends of the floor joists. On our 6x2, 6x3 and 6x4 sizes the bearers will need to run the 6ft length, on our 6x5 and 6x6 sizes the bearers will fix to the gable end as pictured below.

USEFUL TIP! – If you have purchased a Power Base you can screw the floor to the timber Power base below for maximum strength and security.

Reminder

**Ensure bearers are added
to the floor!**

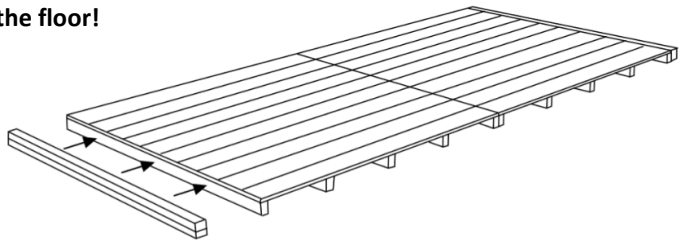

(image showing two heavy duty bearers being attached to each end of the floor)

Walls

1. Please ensure you have removed the transport blocks as per the pre-assembly section.
2. Your garden building will come with a number of wall sections. The quantity of these will depend on the type and size you have ordered. Please see the components table on the previous pages to confirm which panels you should have for your building.
3. Start with the 2ft panel that will be part of your 6ft wall – position this on top of the floor panel. Ensure the side of the panel is flush with outer edge of floor (but not overlapping the heavy duty bearer on the 6x5 and 6x6). Then position one of the gable end panels at the end (sitting on the bearer for the 6x5 and 6x6 sizes) and secure these panels together from the inside using the 50mm screws provided. Use three screws per join.

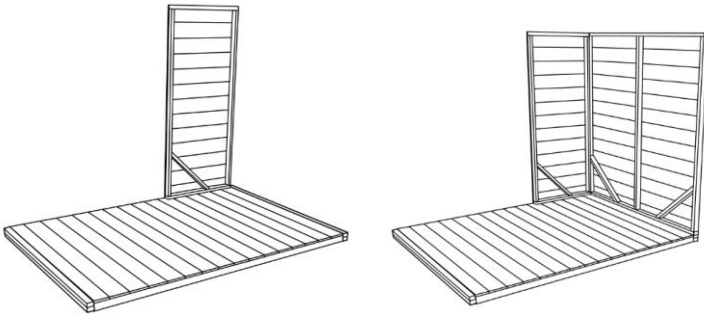

Note - For 6x5 and 6x6 models the ends of the shed will come in more than one section. It does not matter which of these goes to the front and back.

Important!

When securing panels together ensure they line up at the top (so the building is square) and that only the ends of the cladding are shown, which will later be covered with corner strips).

This is only in the corner when the side meets the gable.

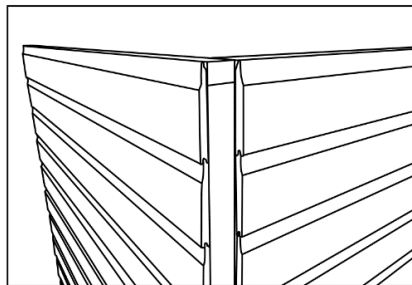

4. Place the remaining 4ft back wall panel and then the other 2ft / 3ft / 4ft end wall panels and again secure using the 50mm screws provided.

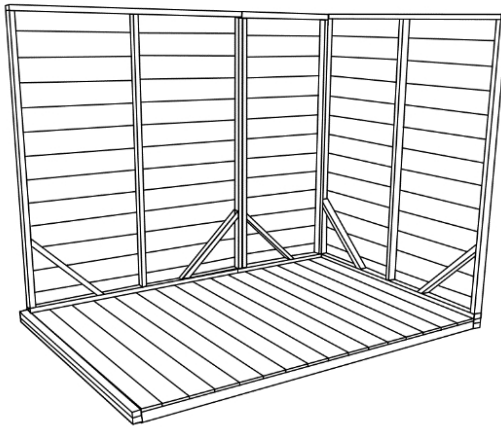

5. Keep going until the back wall and both ends are secured together leaving the front section open.

6. Attach the one panel which goes at the side of doors (called the door wings). Again, continue to use 50mm screws (three screws per join).

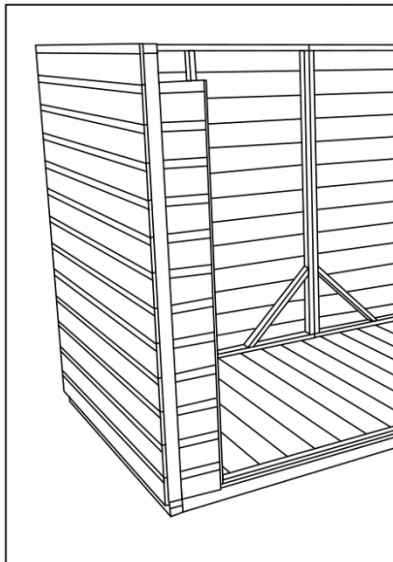

7. Before attaching the other door wing, attach the door sill which looks like a piece of framing in half. This will be screwed to the floor beneath with 35mm screws.

We strongly recommend to pre-drill the holes to avoid splitting.

This sill should be 147mm from each end of the floor (but not the floor bearer) and attached to the very outside edge of the floor. (see image below)

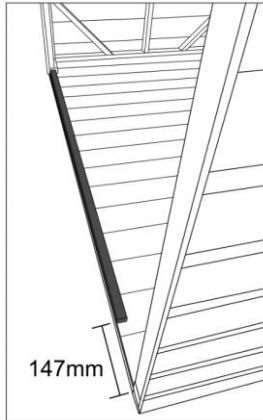

8. You can then secure the other door wing using 50mm screws.

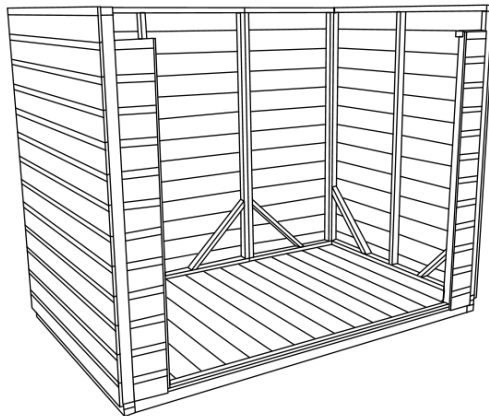

9. Once the two panels are on which go at the side both sides of the doors (door wings), you can add the door head. This is the part which has the 'Power' brand on. To secure these to the panels below you need to screw up through the door wings and into the door head. We strongly advise you to **pre-drill before screwing to avoid the timber splitting.** You can then secure the door head to the side wall panels.

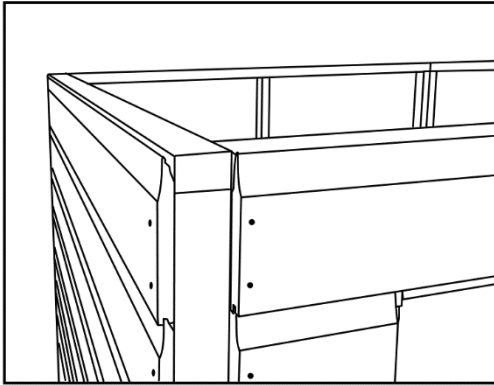

Make sure all the side walls are square and aligned at the top

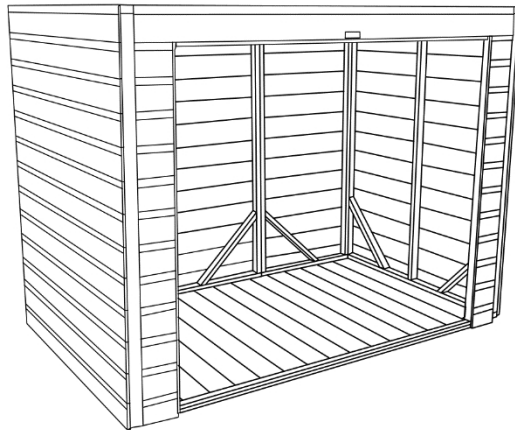

10. When you have secured all the wall panels together you then need to secure these to the floor using 70mm screws provided. Screw into the floor with 2x screws for every wall panel (internally) ensuring the screws are driven through the framing at the bottom of the side/gable walls, through the floorboards and into the floor joists.

USEFUL TIP!

**You can work out the position of the floor joists from the location of the existing nails in the floor.
If the upright framing or corner brace is in the way you would need to nail down into the floor joists at an angle.**

If you are securing these panels against a wall (which gives you little access to nail the cover strips on, explained later) you can pre-assemble a side and move the whole side into position (with the cover lats already nailed on)

Front Top & Gables

The Power Pent Shed can be higher at the front or the back – you can choose this as you assemble it.

1. Add the pent front top to the side you want to be higher and screw to the panels below with 50mm screws. Screwing upwards through the framing from the inside.
2. Do the same with the gables at each end.

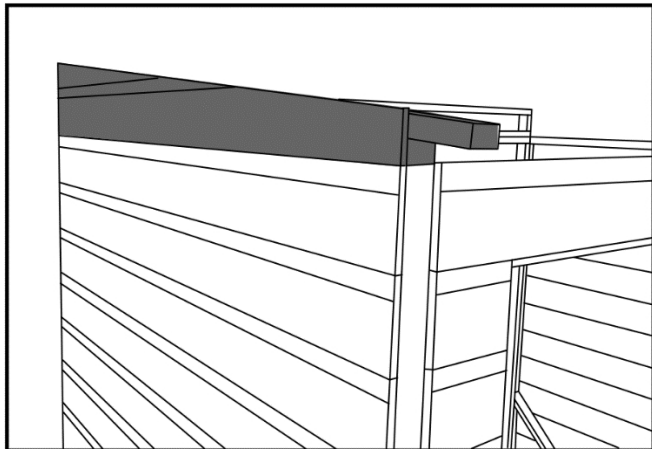
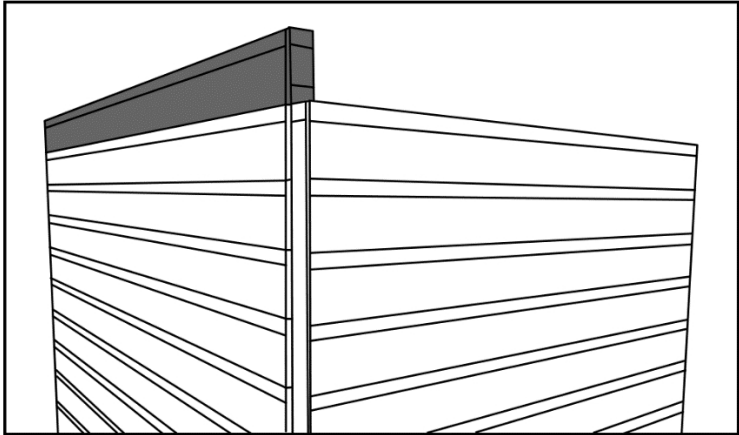

Roof

1. Your pent will come with one roof panel (if it's a 6x2 or 6x3) or two roof panels (if it's 6x4, 6x5 & 6x6).
2. Place the roof panel(s) in place so that the framing on the roof panel run parallel with the gables i.e. from the high side to the low side. These are not handed so can go on either side and does not matter which direction the tongue and groove of the boards run as it will be covered by the felt and bargeboards.

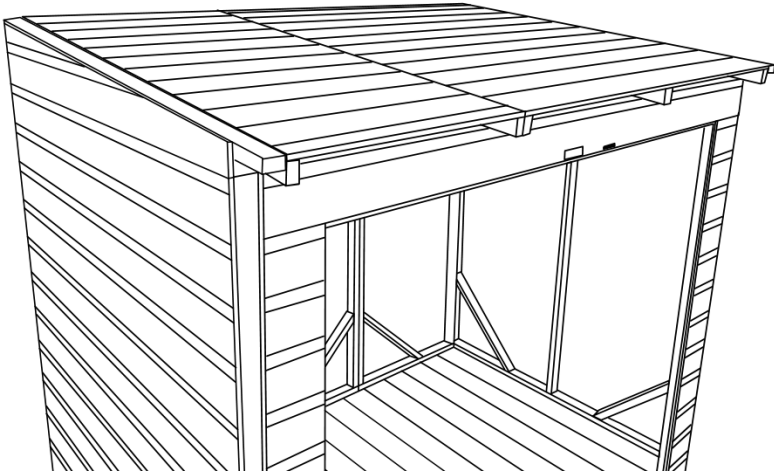

3. Make sure the framing on the roof is in line with the framing on the gable top so that the overhang on the front and back is correct.
4. If applicable, join the roof panels to each other and to the gables using 50mm screws, going through framing from the inside of the building.
5. Then, screw the roof panels to the front and back wall panels with 50mm screws (ensuring you screw up through the framing of the front and back panel into the framing of the roof).

Doors

1. Your shed will come with two doors which you will need to hang.
The door with the lock on will go on the right (as you look at the shed from the outside) and the door with the shoot bolts will go on the left.
2. Position one of the doors in place ensuring the gap between the edge of the door and the shiplap tongue and groove cladding (which you will be screwing the doors in to) is approx. 5mm. This is the same for the top of the door where the gap should also be approx. 5mm.
3. Ensure that it is square and when you are happy with the position, secure the hinges in place using the 25mm screws provided.
4. Repeat this process with the other door.

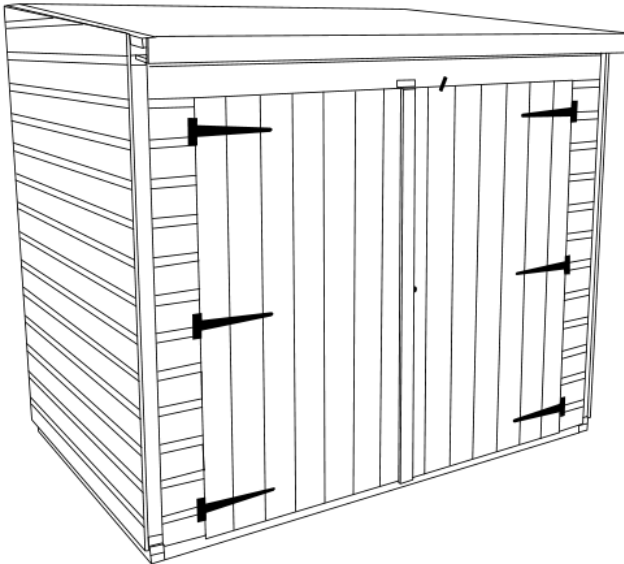

5. Choose a place above the door to secure your turn button.
Be careful not to screw this too tightly or it will not turn.

Felt

Health and Safety – Use safety goggles when installing the roofing felt.



1. Before laying the felt, you will need to attach the back bargeboards (which are 70mm wide) with the 40mm galvanised nails.

These bargeboards may come in more than one section and may need cutting down to size with a saw, depending on which size shed you have chosen.

Be sure not to mix these up with the cover lats which are to go vertically around the shed in corners and covering joins (explained later).

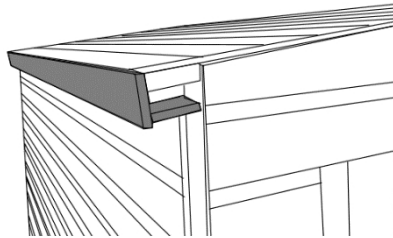

2. Roll out the mineral roofing felt along the lower part of one side of the roof. Allow for sufficient overhang to fold down onto the roof bargeboard (but not the underside roof bargeboard).

Health and Safety – Use Step Ladders to put on the roof felt but do not climb on top of the roof. Ensure there is a second person to support you when using a ladder.

Note – If you are unsure on how to felt the roof please contact us directly for more information. Please be aware, we cannot reimburse you if you choose to purchase additional materials

3. Use clout nails to tack along the top edge of the felt and into the roof board and the bottom edge of the felt into the back bargeboard.
4. Repeat this process along the higher part of the roof.

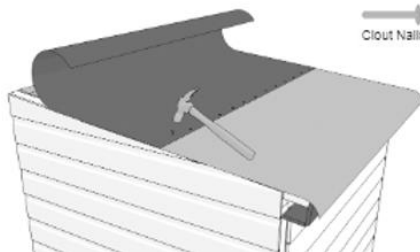

Important!

Take care not to tack into the tongue and groove joint between each board as this can cause leaks.

5. Fold down the overhanging felt on the gable ends and tack this into place. Front and side bargeboards will cover any untidy edges.

Finishing Touches

1. Using the 40mm galvanised nails, fit the bargeboards, which are 70mm wide, to the high side and ends of the roof. Again, these may need cutting down with a saw depending on what size building you have.

Important!

There is no bargeboard for the low side as it could trap rainwater from running off the roof.

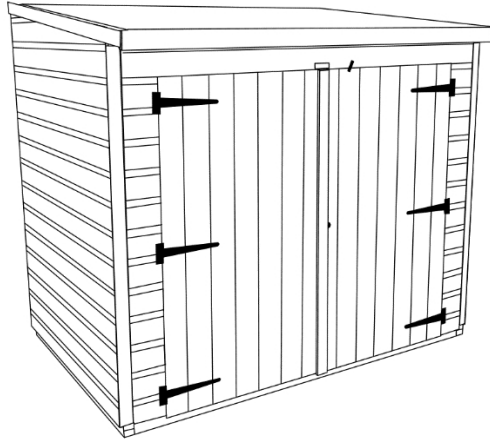

2. Secure the cover lats which are 58mm wide, at each corner of your Power shed with 40mm nails (at least four per strip). Extra strips are provided to cover the joins between side wall panels.
3. Secure the door pull to the door with 25mm screws.
4. Ensure there are no overhanging branches or debris on the shed as this can lead to water ingress. Please be aware, this will need to be checked regularly as part of the maintenance of the shed.
5. Peel the protective blue sticker off the Power branding plate above the door.

Aftercare & Maintenance

Seal Your Windows

We recommend windows are sealed externally with the application of silicone, putty or any other 'watertight' solution at your own preference.

Important!

Please ensure you thoroughly seal the exterior bottom corners of the windows at the edge of the sill.

Shed Preserver

All our sheds come with our Power preservative.

It is important that you re-treat your Power shed annually with a high-quality wood preserver.

Feel free to change the colour of the building giving you the '**power**' to style it your own way.

Take extra care to brush treatment into all wooden components inside and outside.

Please ensure there are no overhanging branches or debris on the shed as this can lead to water ingress.

USEFUL TIP – Looking for some inspiration?

Our Instagram has images of hundreds of Power Sheds which have all been sent to us by customers and is a great way to look at the different ways you can build and paint your shed!

Check Your Base

Although your base should be level at the time of assembly, some bases can move over time and if you find this occurs then the building can twist or door may not close properly.

If such occurrences you may need to pack up the base to keep the building level.

Share Your Shed

Here at Power we love to see your sheds!

Send us photos of your finished sheds to our social media channels using the following handles –

@PowerSheds

#PowerSheds



Instagram



Twitter



Facebook

Power Shed Shelving Instructions

Power Shed Shelving comes 4ft or 6ft long.

You will receive the following components in each shelving pack:

- (4x) board lengths (at either 4ft or 6ft, depending on what you ordered).

Please note: These are 70mm wide and are the same material as the bargeboards.

Be careful not to use these during assembly of your Power Shed – These boards are usually taped together.

- (3x) Brackets
- (2x) Batons
- (1x) Fixing pack - containing 70mm screws and 25mm screws.

Please note:

- When screwing the brackets into position, ensure they are fixed to the internal framing of the shed and not the cladding.
- You may have to cut the board lengths down with a saw to fit, depending on the shed you have ordered.

1. Choose an appropriate location for your shelving and screw the brackets to the internal framing of the shed using the 70mm screws.

2. Use a spirit level to ensure they are level.

Ensure the shelving bracket is the correct way up as per the following diagram:

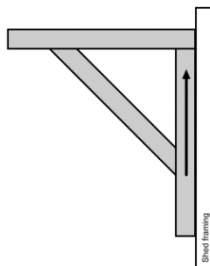

Depending on your shed, there may not be an appropriate place to secure your brackets or there may be framing in an unsuitable position (particularly if the shelf is going on a gable end). We have therefore sent some additional batons to use if required.

3. After the brackets are attached to the framing of the side walls, you can fix the shelving board lengths into the brackets with the 25mm screws. There should be two screws per board per bracket. There should be a small gap between each board length

Returns

If Power is not for you and you'd like to return your shed within 14 days of delivery, then we will collect the item from you without charging a collection fee. No fuss, no fees!

All we ask is that you **do not unpack** the shed or take the shed off the pallet. You will be able to see the shed panels on the pallet if you want to double check the quality of the shed panels.

You need to notify the company you ordered your garden building from to arrange a cancellation or return.

If you have unpacked the shed or taken the shed off the pallet, then you can still return the product to us providing it is within 14 days of delivery, but you will have to cover the cost of returning the item. This will either need to be arranging the delivery yourself (to our manufacturing unit in West Yorkshire) or repacking and securing the goods back onto the pallet and we can arrange a pallet collection for you. The cost of this will depend on your location and the item bought – please contact us if you would like us to advise the cost of this. In this case we will not profit from any courier charges but simply pass on the cost we receive to you.

Any delivery surcharges you have paid (such as a quicker delivery, Saturday delivery, or a timed delivery) will not be refunded.

Once your item has been returned it will be checked to ensure it is complete and in a re-sellable condition. If we deem that the product is not in a re-sellable condition, we shall deduct a reasonable amount to cover any costs to use or return them to you.

Where a refund is to be paid, we will usually refund any money received from you using the same method originally used by you to pay for your purchase.

Contact Us

If you have any queries or issues with your shed then you can:

- Check out our FAQ page on www.PowerSheds.com
- Email us at hello@PowerSheds.com
Please provide photographs of any reported issues*
Any replacement parts can take 1-3 working days.
- Contact us via the telephone – 01274 036 577 (Mon-Fri 08:00 - 16:30)
- Write to us at:

Power Sheds Ltd
21 Commondale Way
Euroway Trading Estate
Bradford
BD4 6SF

- * On the rare occasion that something is missing or damaged, please contact us to make us aware so we can send out any replacements. Replacement parts will be dispatched within 1-3 working days.
- * Please be aware we are unable to reimburse you if you purchase your own materials.
- * We also cannot compensate for subsequential losses such as installation work.