

**NB. Potting Sheds / Summerhouses / Security Sheds** –  
These instructions apply to standard apex sheds as well as potting sheds, security sheds and summerhouses, as they are installed in the same way.

## 10ft Wide Apex Instruction Manual

### WARNING

### UNPACKING SAFELY

Please follow these instructions to unpack your garden building safely



- Two people minimum to unpack
- Place the pallet on firm level ground
- Cut the plastic banding
- Remove each panel by removing screws one column at a time as indicated below
- Be careful of loose components inside the pack when removing panels
- Check all the components against the checklist prior to install

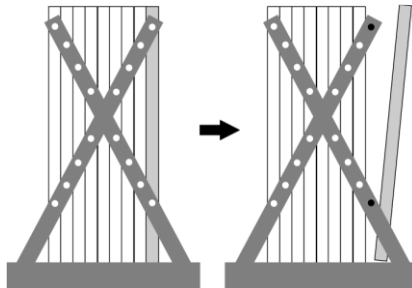

---

### BASE KIT AND FIXING PACK

Please note – if you have ordered a base kit it's unlikely you will be able to see the base kit from the outside of the pack - it will be inside your panels. The fixings are also inside the pack.



**Power Apex**  
**Product Instructions**  
**(10ft Wide Model)**

# Contents

**Page 3 – Before You Start**

**Page 4 – Timber & Base Details**

**Page 5 – 6 – Components Checklist**

**Page 7 – Pre-Assembly**

**Page 8 – 13 – Floor**

**Page 14 – Door**

**Page 15 – 17 – Walls**

**Page 18 – Gable tops**

**Page 19 - 20 – Trusses**

**Page 20 – Roof**

**Page 21 – Felt**

**Page 22 – Finishing Touches**

**Page 23 – Aftercare & Maintenance**

**Page 24 – Shed Shelving Instructions**

**Page 25 – Two Tier Staging Instructions**

# Before You Start

Most accidents are the result of negligence and carelessness, usually caused by the failure of the operator to follow simple but necessary safety precautions.

Do **not** install the garden building before carefully reading this manual and ensuring all components are accounted for and have been checked for any damage.

Visit [www.Powersheds.com](http://www.Powersheds.com) to check the base size for your shed and any other dimensions you may need.

## Health & Safety

Every effort has been made during the manufacturing process to eliminate splinters on the timber.

You are strongly advised to wear gloves when working with or handling timber.

We also strongly advise you to wear safety glasses when installing the felt to protect your eyes.



**2 persons recommended**



Power Sheds Ltd cannot be held responsible for any damage or injury sustained due to incorrect unloading, unpacking, or assembly of any of our products.

## Tools required

(not supplied)



Drill



Spirit level



Hammer



Stanley knife



Step ladder



Saw

## Our treatment

Wear gloves when handling freshly treated wood.

Avoid breathing dust when cutting treated or untreated wood. Dispose of off-cuts responsibly – do not burn.

Contains: IPBC (3-iodo-2-propynyl-N-butyl carbamate) and propiconazole.

May produce an allergic reaction (EUH208). Causes serious eye irritation (H319) Wash skin thoroughly after handling (P264) Wear protective gloves/protective clothing/eye protection/face protection (P280)

**IF IN EYES:** Rinse cautiously with water for several minutes.

Remove contact lenses, if present and easy to do and continue rinsing. (P305 + P351 + P338)

If eye irritation persists: Get medical advice/attention (P337+P313)

# Timber

As timber is a natural product, it is prone to changes in appearance, including some movement, warping, and splitting, particularly in extreme weather conditions. There may be the occasional split, knot, or similar visual imperfections in the timber.

Whilst every effort is made to hand pick timber without visible knotholes or splits there may be occasions where timber is selected in good faith that contains what appears to be a solid knot which over the course of time / during movement of the product it may occur that these small knot holes are then dislodged from the timber leaving a small knot or crack.

Unfortunately, we cannot be held responsible for this maturing of the product and can only offer our best advice as how to deal with this situation in the unlikely event that it should occur which would be to apply some wood filler to the area affected or in extreme circumstances to change the board over.

**None of this should affect the structural integrity of the product.**

## Firm & Level Base

All our garden sheds require a firm and level base.

When thinking about where the garden building and base is going to be constructed:

- Ensure that there will be access to all sides for maintenance work and annual treatment.
- Remember not to place the base too close to any walls or fences, as there may be a slight overhang on the roof which may come into contact with the wall or fence.
- Ensure the base is level and is built on firm ground, to prevent distortion.
- Refer to PowerSheds.com for base dimensions.
- Consider when placing the base next to trees or large bushes as this could cause problems from overhanging branches, especially if these are likely to grow and come into contact with the building in the future and could cause the felt to rip.

The base is slightly smaller than the external measurement of the building, i.e. The cladding should overhang the base, creating a run for water.

It is recommended that the floor is at least 25mm above the surrounding ground level to avoid flooding.

If you have not chosen to purchase our Power Base, then other suitable bases would include a concrete base (75mm of concrete on top of 75mm of hardcore) or a paving slab base (slabs laid on top of 50mm of sharp sand).

## Power Base Kit

If you have ordered a Power Base Kit, the instructions can be found in the small base kit fixing pack.

















Please scan the QR code to watch our base kit installation video –









**Watch the build a base video:**



[www.powersheds.com/faqs/how-do-you-assemble-the-power-sheds-base-kit/](http://www.powersheds.com/faqs/how-do-you-assemble-the-power-sheds-base-kit/)

# Component Checklist

	4x5 Floor	2x5 Floor	2ft Blank Panel	3ft Blank Panel	4ft Blank Panel	4ft Window Panel (or additional blank panels if window/less)	Door Panel (Single or Double)	A1 Roof Panel 651x 1690mm	A2 Roof Panel 651x 1690mm	B Roof Panel 1190 x 1690mm	C Roof Panel 600x 1690mm	D Roof Panel 651 x1690mm	E Roof Panel 951 x1690mm	300mm Joining Batons	10ft Apex Gable Top (left)	10ft Apex Gable Top (centre)	10ft Apex Gable Top (right)
																	
4x10	2	0	0	4	2	1	1	0	0	0	0	4	0	10	2	2	2
6x10	2	2	2	4	2	1	1	0	0	0	0	0	4	12	2	2	2
8x10	4	0	0	4	3	2	1	4	4	0	0	0	0	20	2	2	2
10x10	4	2	2	4	3	2	1	4	4	0	2	0	0	26	2	2	2
12x10	6	0	0	4	4	3	1	4	4	2	0	0	0	26	2	2	2
14x10	6	2	2	4	4	3	1	4	4	2	2	0	0	32	2	2	2
16x10	8	0	0	4	5	4	1	4	4	4	0	0	0	32	2	2	2
18x10	8	2	2	4	5	4	1	4	4	4	2	0	0	38	2	2	2
20x10	10	0	0	4	6	5	1	4	4	6	0	0	0	38	2	2	2

	1485mm Heavy Duty Bearer	Truss Left	Truss Right	Truss 1048mm Framing	Truss Extra Support Piece	Bargeboards	1801 x58mm Cover Lat	Diamond Finial	Felt	Fixing Pack
										
4x10	4	1	1	1	2	4	10	2	16ft Piece @ 1m wide	2
6x10	4	1	1	1	2	4	12	2	(2x) 12ft Piece @ 1m wide	2
8x10	4	1	1	1	2	4	12	2	(2x) 16ft Piece @ 1m wide	2
10x10	4	2	2	2	4	4	14	2	(2x) 20ft Piece @ 1m wide	2
12x10	4	2	2	2	4	4	14	2	(2x) 24ft Piece @ 1m wide	2
14x10	4	3	3	3	6	4	16	2	(4x) 14ft Piece @ 1m wide	2
16x10	4	3	3	3	6	4	16	2	(4x) 16ft Piece @ 1m wide	2
18x10	4	4	4	4	8	4	18	2	(4x) 18ft Piece @ 1m wide	2
20x10	4	4	4	4	8	4	18	2	(4x) 20ft Piece @ 1m wide	2

### Please note

- Cover lats, which are for each corner of the building and to cover any join in each panel (vertically from the outside) are the pieces of timber which are 12mm x 58mm thick.
- Bargeboards, which are for the edges of the roof (although please carefully read the instructions where to put them as some go under the felt and some over the felt) are the pieces of timber which are 12mm x 70mm thick.

# The Fixing Pack

Your fixing pack/s will include:

- 25mm screws (silver)
- 35mm screws
- 50mm screws
- 70mm screws
- Clout nails (for the felt)
- 40mm galvanised nails

If you have ordered a Power Base, you will also receive 80mm and 100mm screws.

On the rare occasion that not enough screws are provided please contact us and make us aware so we can send more out to you. Please be aware we are unable to reimburse if you purchase your own.

## Pre-Assembly

1. Safely unpack your components and check that you have all the parts required. Please use the table in the previous two pages to view which components are required for the size you have ordered.
2. Carefully remove the pallet and any untreated packing timber.
3. Remove any transport blocks from the bottom of the blank and window panels. These are there to offer further protection to the bottom board of the panel.

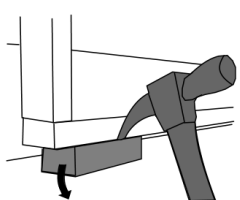

### USEFUL TIP!

Re-treat the underside of the floor before assembly for additional protection and maximum longevity.

## Drilling

In the instructions we will talk about screwing panels together. We recommend this is done with a drill.

We suggest that you pre-drill the timber with a 3mm drill bit before inserting the screws. This will minimise the chance the timber will split.



# Floor

1. Your shed floor will come in a number of 4ft x 5ft panels and for some sizes 2ft x 5ft panels. These need to be laid out onto your firm and level base into the desired position of your shed.
2. Be sure to consider any overhangs on the shed when deciding the correct position as per the instructions regarding bases in the 'Before You Start' section.  
The layout of the floor is as follows:

## 4x10

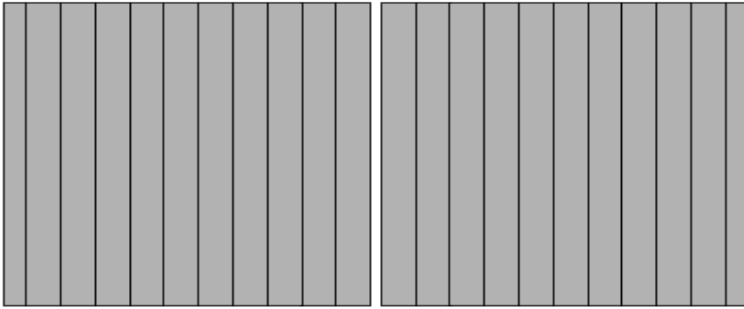

## 6x10

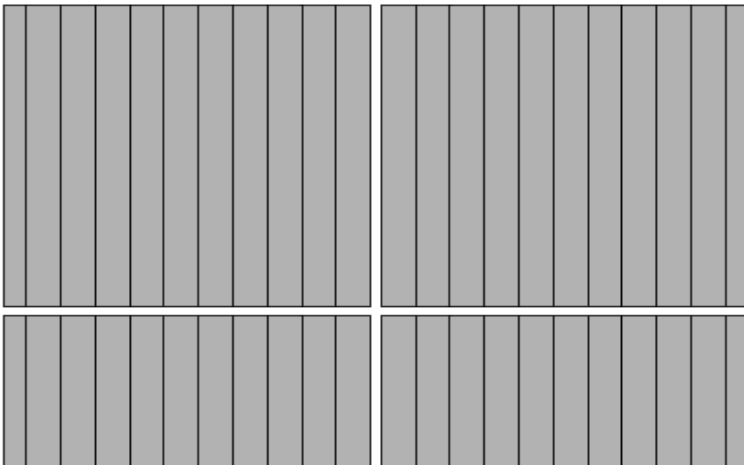

**8x10**

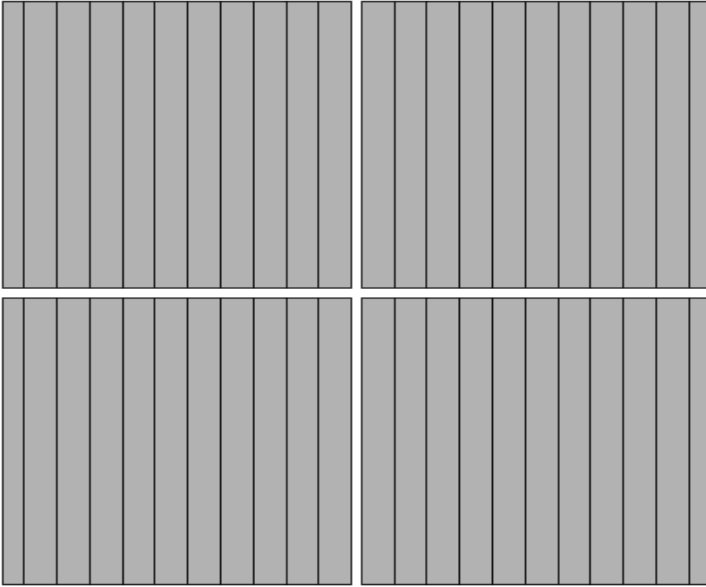

**10x10**

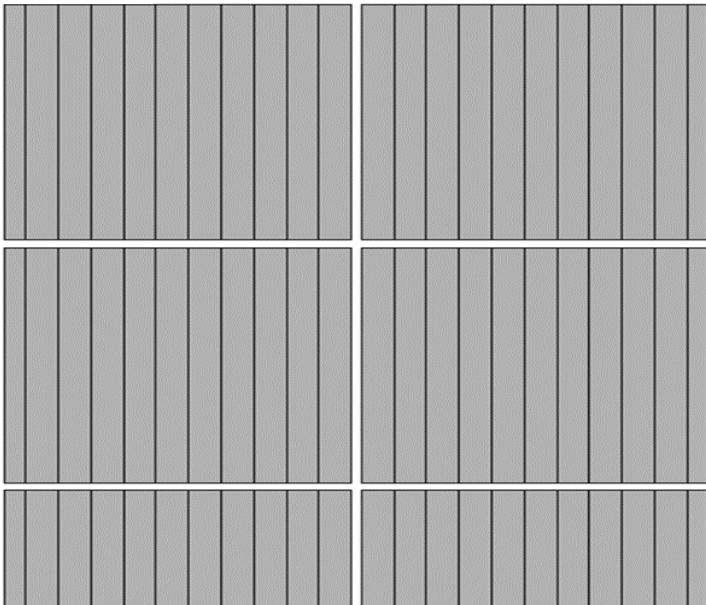

And so, on up to  $20 \times 10$  which will be:

**$20 \times 10$**

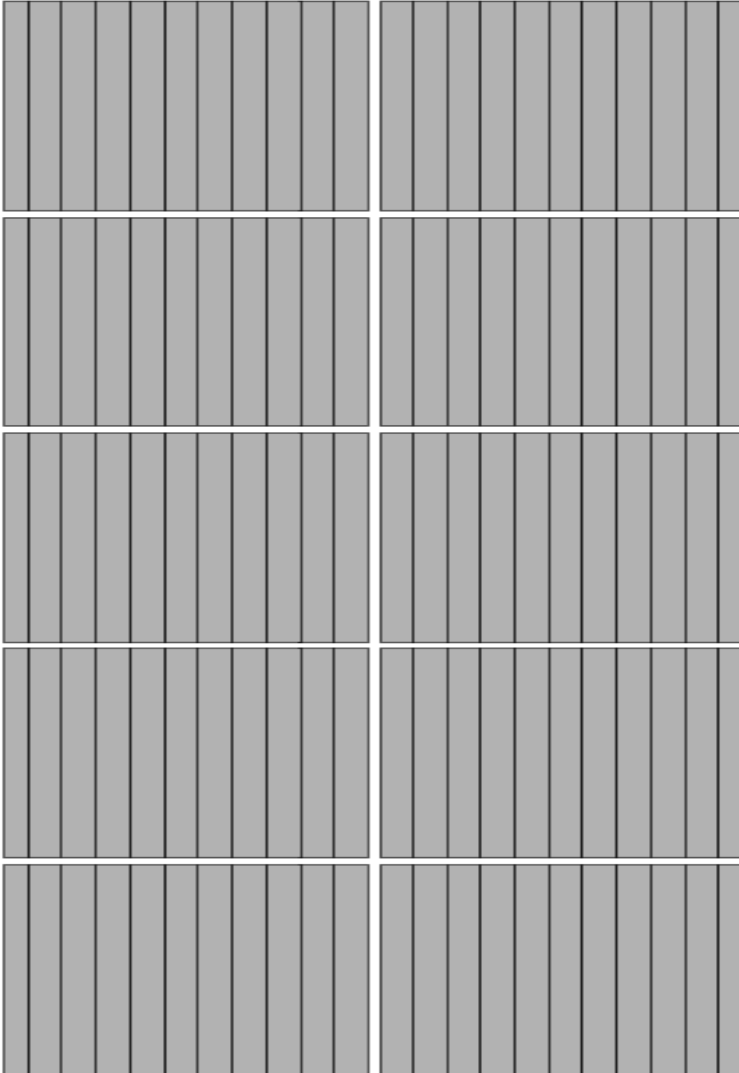

As you can see, the floor panels with the full board will be central (so join with the groove of one panel meeting the groove of the joining panel) and the cut board will be to the edge of the building –

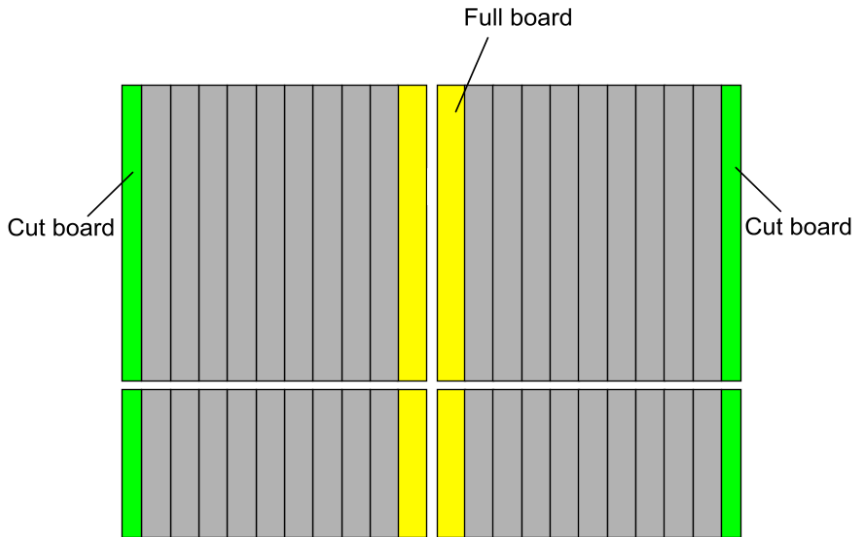

1. You now need to join the floor panels together.  
To do this you will be provided with a number of joining batons to aid you.

**Important!**

Although the outer bearers will line up, the central bearers **do not**.  
This is completely normal and nothing to be concerned about.

2. For each row of floor panels, turn them upside down and join using joining blocks as follows using two 50mm screws per joining block to create 10ft floor panels -

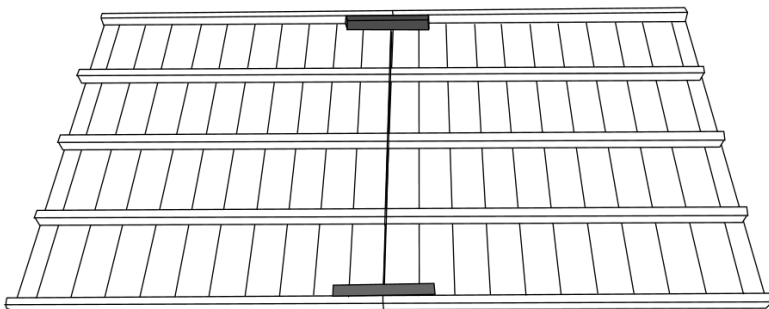

3. Leaving the floor panels upside down you can join to the next row of floor panels using 6 x 50mm screws per join as follows:

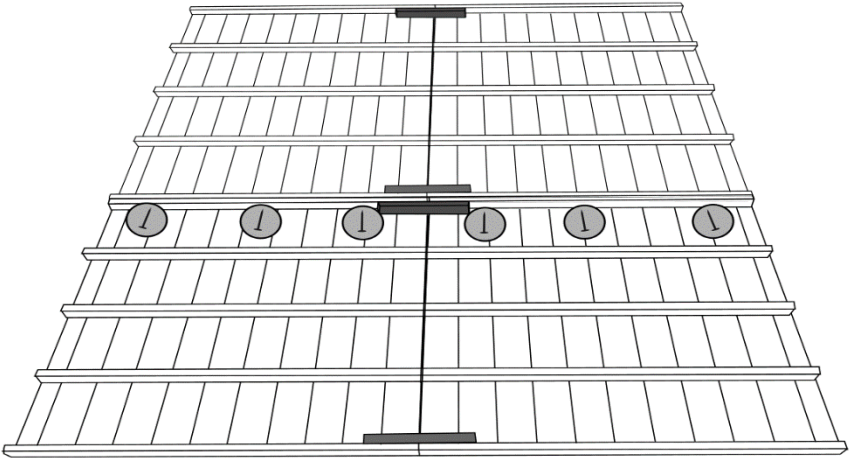

4. At this stage we would advise turning these floor panels back the right way round. If you continue to add and join more floor panels you will find it very difficult to turn them back over.

You can then repeat the process with the next set of floor panels until the whole floor is back the right way around.

5. You now need to join the larger sections of two or four floor panels together so that the whole floor is joined.

For the larger sizes, where you couldn't join the whole floor together upside down, you will need to join the sections together whilst it is the correct way up. To do this, simply screw the floor joists together at the side of the floor at an angle connecting the two floor joists together. Do this with 70mm screws and be sure to pre-drill the timber to avoid splitting.

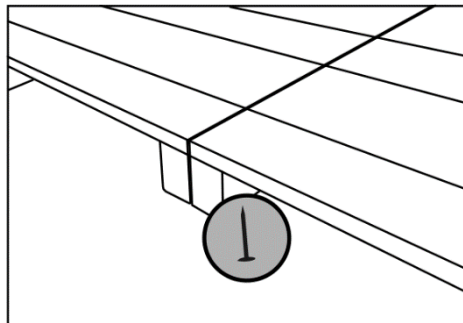

- Once all the floor panels are the correct way up and screwed together, you then need to screw the four 'heavy duty bearers' which are two pieces of framing joined together, to each gable end (the end where the triangular 'gable tops will go later').

There will be (4x) 1485mm bearers – two for each 10ft gable end.

**Important!**

Whichever size shed you have; the bearers must go on the 10ft sides.

E.g. if you have a 4x10, still put the bearers on the 10ft sides (even though the bearers come in 5ft lengths).

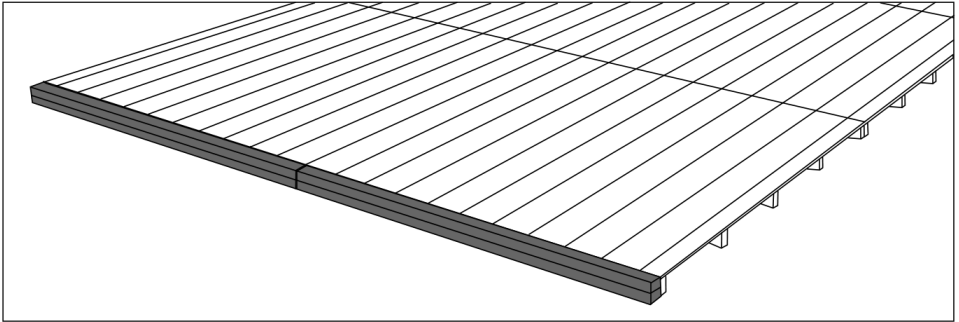

# Door

1. Your shed will either come with a single door or a double door depending on what you selected when ordering. Double doors are already hung on the door panel. However, for a single door you will need to hang the door. The key is screwed to the back of the door.

**For a single door you can choose which way round to hang it – left hand or right hand.**

**Note** – If you choose a left-hand hinged door then the lock must be unscrewed and positioned the correct way round as it will be upside down. You may need to drill new holes for this to be fitted correctly.

2. For a single door, lay the door panel on the floor and. Line up the door onto the framing so that it is square. The door should be positioned closer to the side where the hinges go. Make sure the lock is on the inside of the shed when the door is closed. Secure the hinges in place using the 25mm screws provided.
3. Choose two places on the door to secure your two turn buttons – one towards the top, one towards the bottom. For double doors a turn button will already be secured. Be careful not to screw this too tightly or it will not turn.

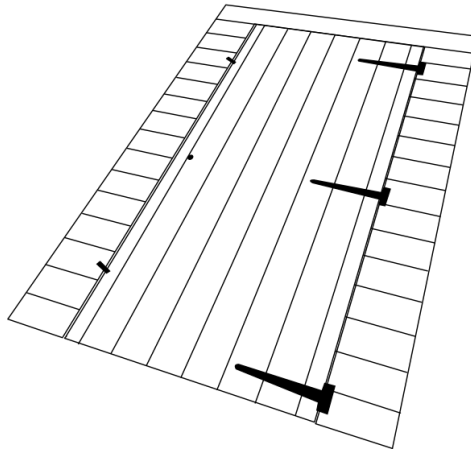

## **Important!**

**Make sure the door is unlocked before the next stage or once you have assembled the side walls you will not be able to get into your shed.**

# Walls

1. Please ensure you have removed the transport blocks as per page 7.
2. Your shed will come with a number of wall sections. The quantity of these will depend on which type and size you ordered – there could be 2/3/4ft Blank Panels, 4ft Window Panels (unless you have selected the windowless version), and a door panel (which could be a single door or double door).  
Please see the components table to confirm which panels you should have for your Power Apex shed.
3. Lay out the wall panels in the configuration you want for your garden building.

## Important!

The 3ft blank panels **must** be used on the 10ft gable ends. It is highly recommended to use a 3ft blank panel either side of a 4ft panel of your choosing so that the cover lats will line up when adding these at the end. This panel could either be a door, blank or window panel (if purchased a building with windows) so the finishing pieces align with the gable top.

4. Start with the first 3ft panel that will be part of your 10ft gable end – position this on top of one of the heavy-duty bearers which you attached in the previous section. Ensure the side of the panel is flush with the side of the floor.

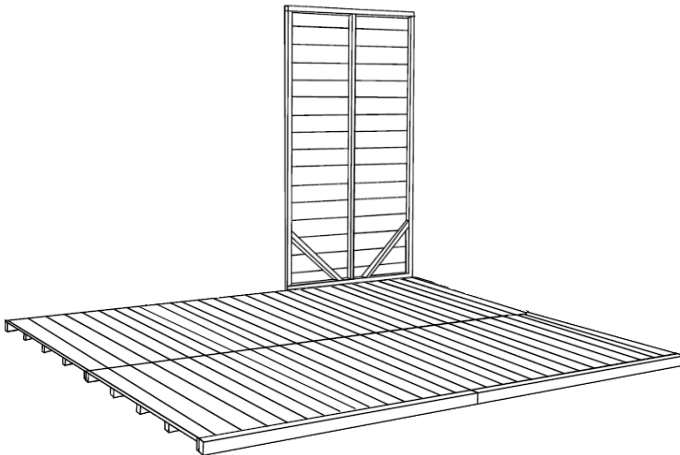



5. You will then need to position one of the 4ft or 2ft panels at a right angle to the 3ft wall panel you have chosen to start the first corner.
6. Secure these panels together from the inside using the 50mm screws provided using three screws per join.

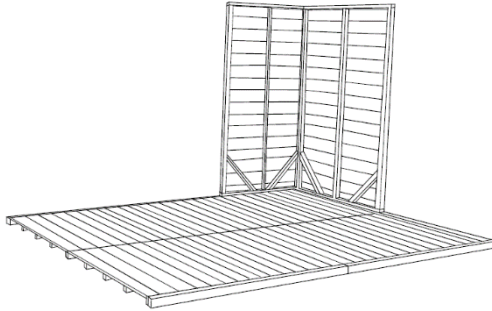

**Important!**

**When securing panels together ensure they line up at the top (so the building is square) and that only the ends of the cladding are shown, which will later be covered with corner strips. This is only in the corner when the side meets the gable.**

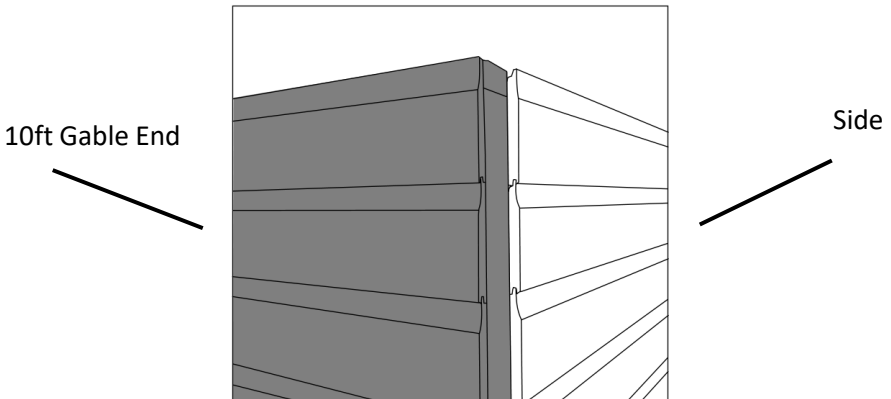

7. Begin placing more wall panels, securing them using the 50mm screws provided. Again, use three screws per join.

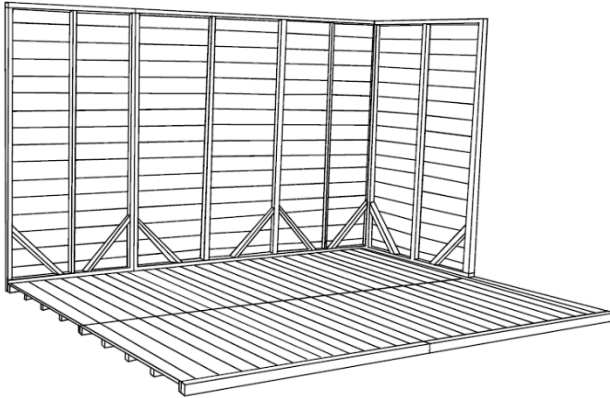

8. Continue doing this to place all remaining wall panels into position.

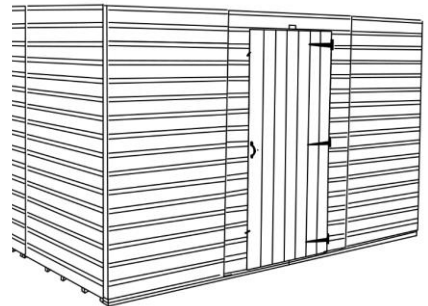
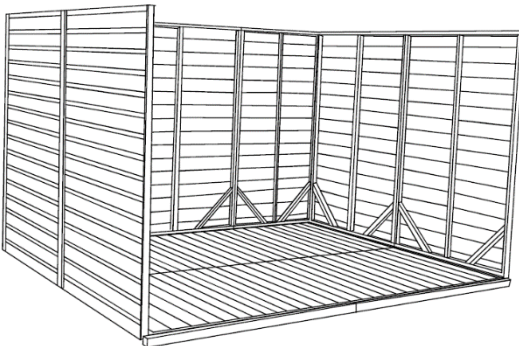

9. When you have secured all the wall panels (door panel, 2ft, 3ft and 4ft blank panels, window panels) you then need to secure these to the floor using 70mm screws provided. Screw into the floor with 2x screws for every wall panel (internally) ensuring the screws are driven through the framing at the bottom of the side/gable walls, through the floorboards and into the floor joists.

#### USEFUL TIPS!

**You can work out the position of the floor joists from the location of the existing nails in the floor. It may need screwing at an angle to ensure the screws go into the floor joists as bracing or upright pieces of framing could be in the way**

**If you are securing these panels against a wall (which gives you little access to nail the cover strips on, explained later) you can pre-assemble a side and move the whole side into position (with the cover lats already nailed on)**

# Gable Tops

1. The 10ft gable tops will come in three sections. These need to be joined together with three 50mm screws as follows:

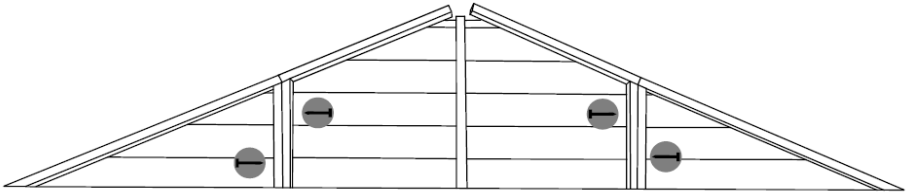

2. Line up the gable tops with the panels at the 10ft gable ends (the ends where you attached the 'heavy duty bearers').
3. Secure them to the wall panels with 50mm screws from the inside, screwing upwards through the framing.

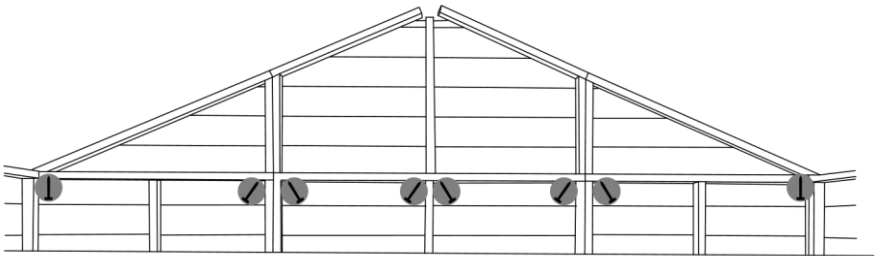

4. Complete this at each end of the shed.

# Trusses

1. Each building will be supplied with at least one truss, consult the component checklist to see how many your building will arrive with.

Each truss will come in five parts:

- a. (1x) left triangular section
  - b. (1x) a right triangular section
  - c. (1x) a piece of framing at 1048mm long for the bottom of the truss
  - d. (2x) triangular support pieces for the top
2. Start by screwing the left and right triangular sections together with (2x) 50mm screws:

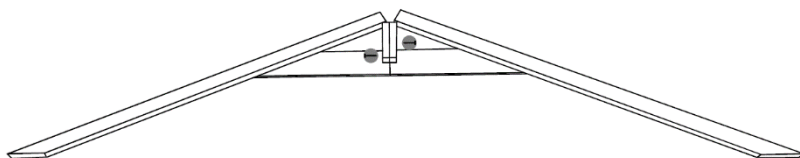

3. Then add the piece of framing at 1048mm long for the bottom the truss, attaching with 50mm screws as follows. The bottom of the 1048mm long piece of framing should line up perfectly with the bottom of the cladding on the truss.

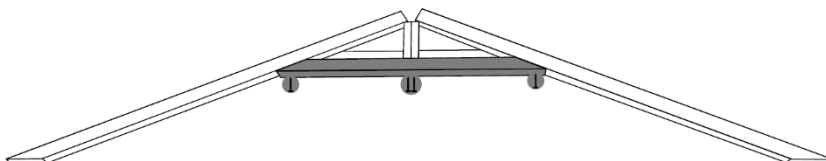

4. From the other side, add some 40mm galvanised nails going through the cladding and into this 1048mm framing to give some additional strength and support.
5. Finish the truss by adding the triangular support piece for the top and secure using 40mm galvanised nails. **This will need adding to both sides of each truss.**

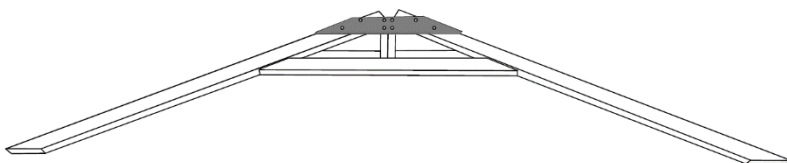

6. The finished truss will look as follows –

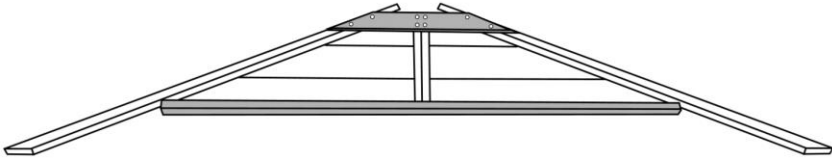

7. Repeat this process for all other trusses. The number of trusses required is stated in the component checklist.

## Roof

As separate set of instructions explaining the roof installation process for your specific shed will be attached to the pallet.

**Please note** – The tongue & groove roof panels do **NOT** interlock as the panels are butt jointed together.

*Roof Instructions Example -*

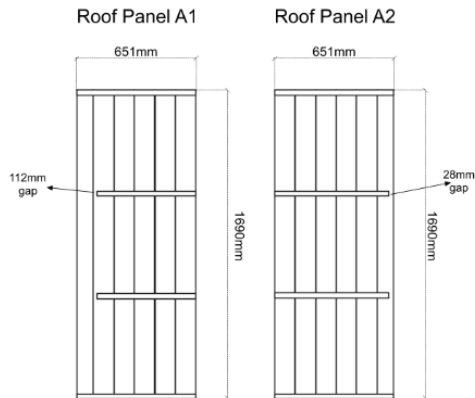

On a 8x10, the roof components are:

- (4x) Roof Panel A1
- (4x) Roof Panel A2
- (18x) 300mm roof batons - note there was an additional (2x) 300mm batons for the floor, so (20x) in total.

The truss components are:

- (1x) Roof Truss Left
- (1x) Roof Truss Right
- (1x) 1048mm Truss piece of framing
- (2x) Roof truss triangular support piece

**Please note** – at this stage you should have already built up the trusses as per the main instructions.

# Felt

**Health and Safety – Use safety goggles when installing the roofing felt.**



1. Roll out the mineral roofing felt along the lower part of one side of the roof. Allow for sufficient overhang to fold down onto the roof framing (but not the underside of the roof).



**Health and Safety – Use Step Ladders to put on the roof felt but do not climb on top of the roof. Ensure there is a second person to support you when using a ladder.**

**Note** - On the rare occasion that you have not been provided with enough felt please contact us so we can arrange for more to be sent. Please be aware, we cannot reimburse you if you choose to purchase additional materials

2. Use clout nails to tack along the top edge of the felt and into the roof boards. Repeat this process on the other side of the roof.

**Take care not to tack into the tongue and groove join between each board as this can cause leaks.**

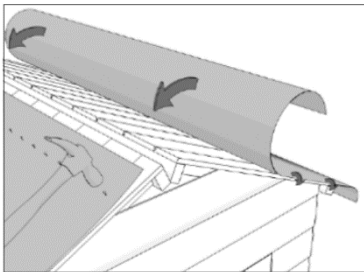

3. You will then receive three additional pieces of felt to then cover the rest of the roof. This can be secured to the roof using clout nails.
  - Fold the overhanging felt at the gable ends under the roof boards and tack into place.

## **Important!**

The **4x10** and **6x10** Power Apex roof panels will finish flush with the gables so the felt will not tuck under.

# Finishing touches

1. Using the 40mm galvanised nails, fit the bargeboards to the roof panels and secure the diamond finials over the top of the bargeboards.
2. Secure corner strips at each corner of your Power shed with 40mm nails (at least four per strip). Extra strips are provided to cover any joins between side wall panels.

**Note** – the cover strips for the gable ends will come in two pieces.

Ensure the full piece is at the top (this will tie in the gable top to the panel beneath) and then the strip underneath will need to be cut down to fit.

3. Secure the door pull to the door with 25mm screws.
4. Ensure there are no overhanging branches or debris on the shed as this can lead to water ingress. Please be aware, this will need to be checked regularly as part of the maintenance of the shed.
5. Peel the protective sticker off the Power branding plate above the door.

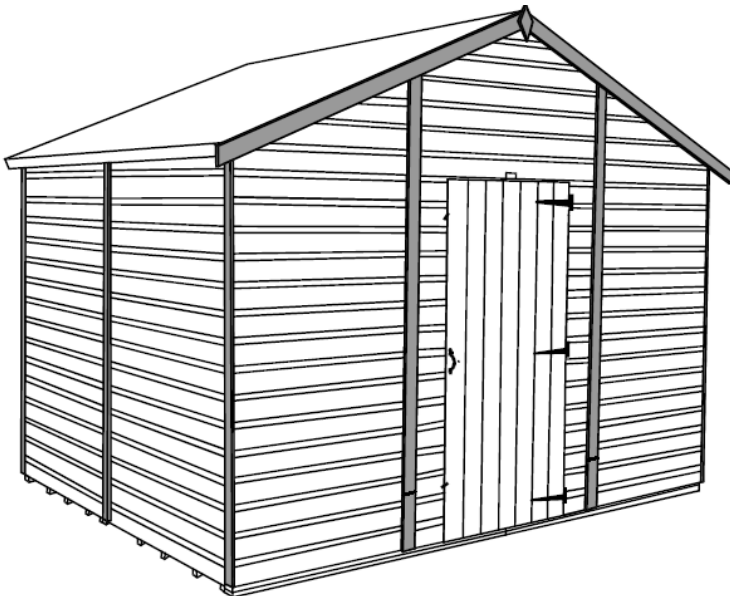

# Aftercare & Maintenance

## Seal your windows

We recommend windows are sealed externally with the application of silicone, putty, or any other 'watertight' solution at your own preference.

### Important

**Please ensure you thoroughly seal the exterior bottom corners of the windows at the edge of the sill.**

## Shed preserver

All our sheds come with our Power preservative.

It is important that you re-treat your Power shed annually with a high-quality wood preserver.

Feel free to change the colour of the building giving you the 'power' to style it your own way.

Take extra care to brush treatment into all wooden components inside and outside.

Please ensure there are no overhanging branches or debris on the shed as this can lead to water ingress.

### USEFUL TIP – Looking for some inspiration?

Our Instagram has images of hundreds of Power Sheds which have all been sent to us by customers and is a great way to look at the different ways you can build and paint your shed!

## Check your base

Although your base should be level at the time of assembly, some bases can move over time and if you find this occurs then the building can twist, or door may not close properly.

If such occurrences, you may need to pack up the base to keep the building level.

## Share Your Shed

Here at Power, we love to see your sheds!

Send us photos of your finished sheds to our social media channels using the following handles –

**@PowerSheds**

**#PowerSheds**



**Instagram**



**Twitter**



**Facebook**



# Power Shed Shelving Instructions

Power Shed Shelving comes 4ft or 6ft long.

You will receive the following components in each shelving pack:

- (4x) board lengths (at either 4ft or 6ft depending on what you ordered).  
**Please note:** These are 70mm wide and are the same material as the bargeboards. Be careful not to use these during assembly of your Power Shed
- (3x) Brackets
- (2x) Batons
- (1x) Fixing pack - containing 70mm screws and 25mm screws.

**Please note:**

- When screwing the brackets into position, ensure they are fixed to the internal framing of the shed and not the cladding
  - You may have to cut the board lengths down with a saw to fit depending on the shed you have
1. Choose an appropriate location for your shelving and screw the brackets to the internal framing of the shed with the 70mm screws.
  2. Use a spirit level to ensure they are level.  
Ensure the shelving bracket is the correct way up as per the diagram following:

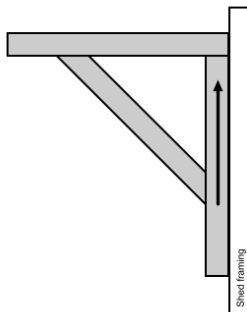

Depending on your shed, there may not be an appropriate place to secure your brackets or there may be framing in an unsuitable position (particularly if the shelf is going on a gable end). We have therefore sent some additional batons to use if required.

3. After the brackets are attached to the framing of the side walls, you can fix the shelving board lengths into the brackets which the 25mm screws. There should be two screws per board per bracket. There should be a small gap between each board length.

# Power Two-Tiered Staging Unit Installation Instructions

Power Shed Staging Units come at either 2ft or 4ft long.

You will receive the following components in each **individual** staging pack:

- (2x) Shelving Panels (either 2ft or 4ft)
- (2x) Legs (for the front of the panels only)

## Please note:

- Depending on where you decide to install the staging units – you may need to cut the panels down. Before attaching the panels to the framing ensure they are correctly sized.
  - Use 70mm screws from the fixing pack to attach the shelving panels to the framing.
  - When screwing the shelving into position, ensure they are fixed to the internal framing of the shed and not the cladding
1. The staging units are designed to fit our Power Potting Shed window panels (however can be attached to any shed in our range), being fixed against the internal framing of the shed with the 70mm screws.
  2. Use a spirit level to ensure they are level. We would recommend to pre-drill the holes for the screws to ensure the timber does not split.

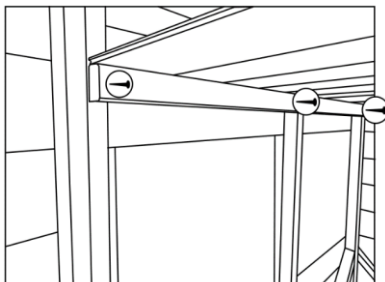

3. Fix the legs to the shelves, once again using the 70mm screws. After these are added continue adding each additional staging unit (if necessary) securing batons as you go.

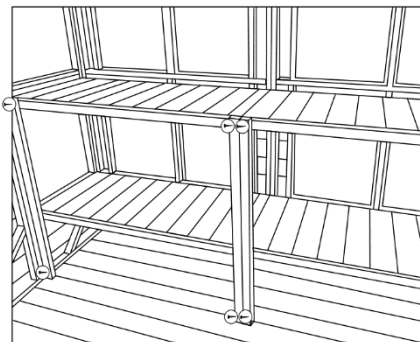

# Returns

If Power is not for you and you'd like to return your shed within 14 days of delivery then we will collect the item from you without charging a collection fee. No fuss, no fees!

All we ask is that you **do not unpack** the shed or take the shed off the pallet. You will be able to see the shed panels on the pallet if you want to double check the quality of the shed panels.

You need to notify the company you ordered your garden building from to arrange a cancellation or return.

If you have unpacked the shed or taken the shed off the pallet, then you can still return the product to us providing it is within 14 days of delivery but you will have to cover the cost of returning the item. This will either need to be arranging the delivery yourself (to our manufacturing unit in West Yorkshire) or repacking and securing the goods back onto the pallet and we can arrange a pallet delivery for you. The cost of this will depend on your location and the item bought – please contact us if you would like us to advise the cost of this. In this case we will not profit from any courier charges but simply pass on the cost we receive to you.

Any delivery surcharges you have paid (such as a quicker delivery, Saturday delivery, or a timed delivery) will not be refunded.

Once your item has been returned it will be checked to ensure it is complete and in a re-sellable condition. If we deem that the product is not in a re-sellable condition, we shall deduct a reasonable amount to cover any costs to use or return them to you.

Where a refund is to be paid we will usually refund any money received from you using the same method originally used by you to pay for your purchase.

# Contact Us

If you have any queries or issues with your shed then you can:

- Check out our FAQ page on [www.PowerSheds.com](http://www.PowerSheds.com)
- Email us at [hello@PowerSheds.com](mailto:hello@PowerSheds.com)  
Please provide photographs of any reported issues\*  
Any replacement parts can take 1-3 working days.
- Contact us via the telephone – 01274 036 577 (Mon-Fri 08:00 - 16:30)
- Write to us at: Power Sheds Ltd  
21 Comondale Way  
Euroway Trading Estate  
Bradford  
BD4 6SF

- \* On the rare occasion that something is missing, please contact us to make us aware so we can send out any replacements. Replacement parts will be dispatched within 1-3 working days.
- \* Please be aware we are unable to reimburse you if you purchase your own materials.
- \* We also cannot compensate for subsequential losses such as installation work.