



HOW TO ASSEMBLE

AQUILA™ 3x5 / 1x1.5

IMPORTANT!

Please read these instructions carefully before starting assembly.
Keep these instructions in a safe place for future reference.









A member of
Palram Industries Ltd.

www.canopia.com





AVAILABLE MODELS

<p>3x5 / 1x1.5</p>		<p>PRIMARY UNIT 3x5 / 1x1.5</p>	<p>1 BOX</p> 
<p>3x10 / 1x3</p>		<p>PRIMARY UNIT 3x5 / 1x1.5</p>	<p>2 BOXES</p> 
<p>3x15 / 1x4.5</p>		<p>PRIMARY UNIT 3x5 / 1x1.5</p>	<p>3 BOXES</p> 
		<p>CONNECTOR KIT</p>	<p>2 BOXES</p> 

4 WAYS TO WATCH OUR VIDEO



1 Scan QR Code



2 Search on YouTube

YouTube

Palram - Canopia
Aquila Assembly



3 Go to

<http://bit.ly/2qjJLSY>

4 Visit us

<https://canopia.com/product/aquila-door-awning/>



AFTER SALES SERVICE

WE´VE GOT YOU COVERED

NOUS NOUS OCCUPONS DE VOUS | NOS OCUPAMOS DE UD | WIR HELFEN IHNEN GERNE

EN

Our self-service form makes it convenient and fast.
Go to the URL below or scan the QR code with your phone to submit your request.

FR

Notre formulaire en ligne est pratique et rapide.
Rendez vous sur l'URL ci-dessous ou scannez le code QR avec votre téléphone pour soumettre votre demande.

ES

Nuestro formulario de autoservicio lo hace conveniente y rápido. Vaya al URL de abajo o escanee el código QR con su teléfono para enviar su solicitud.

DE

Nutzen Sie schnell und bequem unser Kontaktformular.
Rufen Sie die untenstehende URL auf oder scannen Sie den QR-Code mit Ihrem Handy, um Ihre Anfrage zu übermitteln.

Missing a part or need a new one?

Il vous manque une pièce ou vous avez besoin d'une pièce supplémentaire?
Me falta una pieza o necesito una nueva?
Fehlt ein Teil oder benötigen Sie ein Ersatzteil?



canopia.shop/part_request

SCAN ME

Need help assembling your product?

Besoin d'aide pour monter votre produit?
Necesito ayuda para montar mi producto?
Benötigen Sie Hilfe bei der Montage Ihres Produkts?



canopia.shop/support

SCAN ME



CUSTOMER SUPPORT



SCAN ME

WE ARE HERE TO HELP

For general questions: canopia.com/contact-us

USA	
	877-627-8476
	generalsupport@poly-tex.com

CANADA	
	905-5646007
	sales@footprintproducts.com

UNITED KINGDOM • IRELAND	
	01302-380775
	customer.serviceUK@palram.com

GERMANY	
	0180-522-8778
	customer.serviceDE@palram.com

FRANCE • BELGIUM	
	+33-169-791-094
	customer.serviceFR@palram.com

ISRAEL	
	04-848-6816
	customer.service@palram.com

ITALY • NETHERLANDS • PORTUGAL • SPAIN	
	+33-169-791-094
	customer.serviceFR@palram.com

AUSTRIA • LUXEMBURG • LIECHTENSTEIN	
	+49-180-522-8778
	customer.serviceDE@palram.com

AUSTRALIA	
	03-9219-4444
	salesvic@palram.com

NORWAY • SWEDEN • ARGENTINA • GREECE • GREENLAND • ICELAND • ESTONIA • JAPAN • LATVIA • LITHUANIA
 MAURITIUS • MEXICO • ROMANIA • RUSSIA • TURKEY • UZBEKISTAN • UKRAINE • SWAZILAND • KOREA

	+972-4-848-6816
	customer.service@palram.com



CUSTOMER SUPPORT



SCAN ME

WE ARE HERE TO HELP

For general questions: canopia.com/contact-us

AUSTRALIA - GREENHOUSES



03-9544-6-999



info@mazedistribution.com.au

DENMARK



07-575 42 70



post@nshnordic.com

HUNGARY · SLOVAKIA



+420-493-523-523



servis@garland.cz

SOUTH AFRICA



011-397-7771



receptionza@palram.com

NEW ZEALAND



0800 800 880



customer.service@palram.com

CROATIA · SLOVENIA



0599-37-057



info@ms-viscom.com

CZECH REPUBLIC



0493-523-523



servis@garland.cz

FINLAND



Neuvonta: 09-6866720
Tuki / Varaosat: 050-3715350



www.horisontenterprises.fi
tuki@horisontenterprises.fi

POLAND



Infolinia: 801-011-929
22-349-93-36



kontakt@ogrodosfera.pl

CYPRUS



0224-971-13



alpaco@alpacodomica.com
www.alpacodomica.com

SWITZERLAND



062-287-33-77



info@ritter.ch













SAFETY ADVICE

- It is of utmost importance to assemble all of the parts according to the directions. Do not skip any steps.
- We strongly recommend using work gloves during panel sliding.
- Some parts may have sharp edges. Please be careful when handling components.
- Always wear shoes and safety goggles when working with extruded aluminium.
- If using a step ladder or power tools make sure that you follow the manufacturer's safety advice.
- Keep children away from the assembly area.
- Do not touch overhead power cables with the aluminium profiles.
- Do not attempt to assemble the product in windy or wet conditions.
- Dispose of all plastic bags. Keep them out of reach of small children.
- Do not climb or stand the roof.
- Do not hang or lay the profiles.
- Do not position your product in an area exposed to excessive winds.
- Do not attempt to assemble this product if you are tired, have taken drugs or alcohol or if you are prone to dizzy spells.
- Make sure there are no hidden pipes or cables in the wall before inserting the pegs.
- This product is designed to be used mainly as a Door Awning.
- Heavy snow load on the roof can make it unsafe to stand below or nearby.
- **The wall anchoring kit supplied with this product is suitable for concrete or solidbrick walls. Other wall types need an accordant wall fixation kit.**











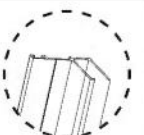



CARE & MAINTENANCE

- When your product needs to be cleaned, use a mild detergent solution and rinse with cold clean water.
- DO NOT use acetone, abrasive cleaners or other special detergents to clean the panels.
- Clean the product once assembly is complete.

TOOLS & EQUIPMENT

- | | | | | | | | |
|---|--|---|--|---|--|---|---|
|  | <input type="checkbox"/> 2 people needed |  | <input type="checkbox"/> Work gloves |  | <input type="checkbox"/> Spirit Level |  | <input type="checkbox"/> Philips head Screwdriver |
|  | <input type="checkbox"/> Pencil |  | <input type="checkbox"/> Electric Drill With Drill Bit 8mm 5/16" |  | <input type="checkbox"/> Electric Drill With Drill Bit 10mm 13/32" |  | <input type="checkbox"/> Ladder |
|  | <input type="checkbox"/> Tape measure |  | <input type="checkbox"/> Wrench 10 mm 13/32" |  | <input type="checkbox"/> Wrench 13 mm 1/2" |  | <input type="checkbox"/> Scissors |

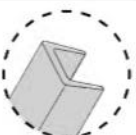
Contents

Item	Qty.	Item	Qty.	Item	Qty.
1000	1			1003	2
1002	1			450	2
1019	2			4006	4
1018	1			4009	4
9613	1			4000	6
9612	1			4010	6
3004	2			5000	6
3005	1			4020	6
9619	2				
7872	1				

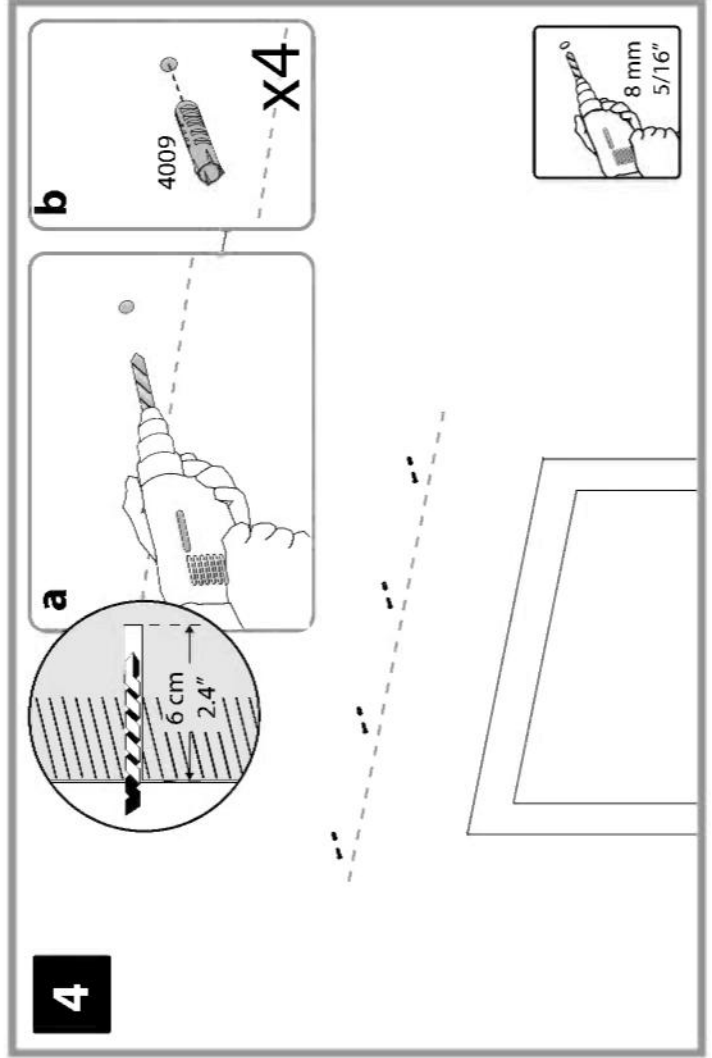
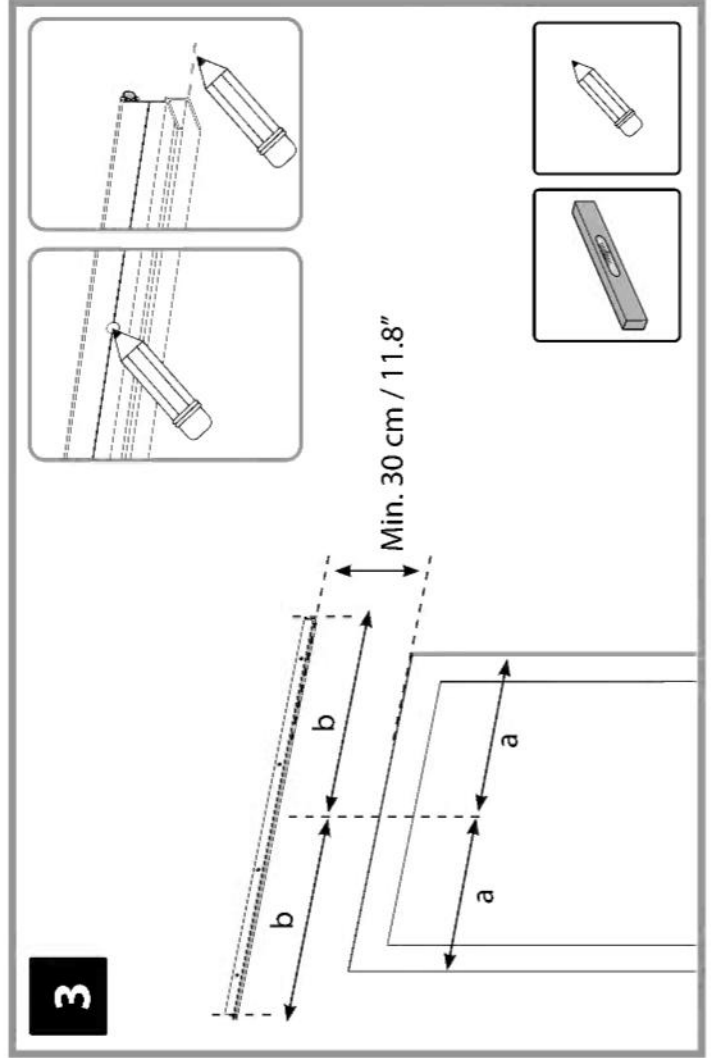
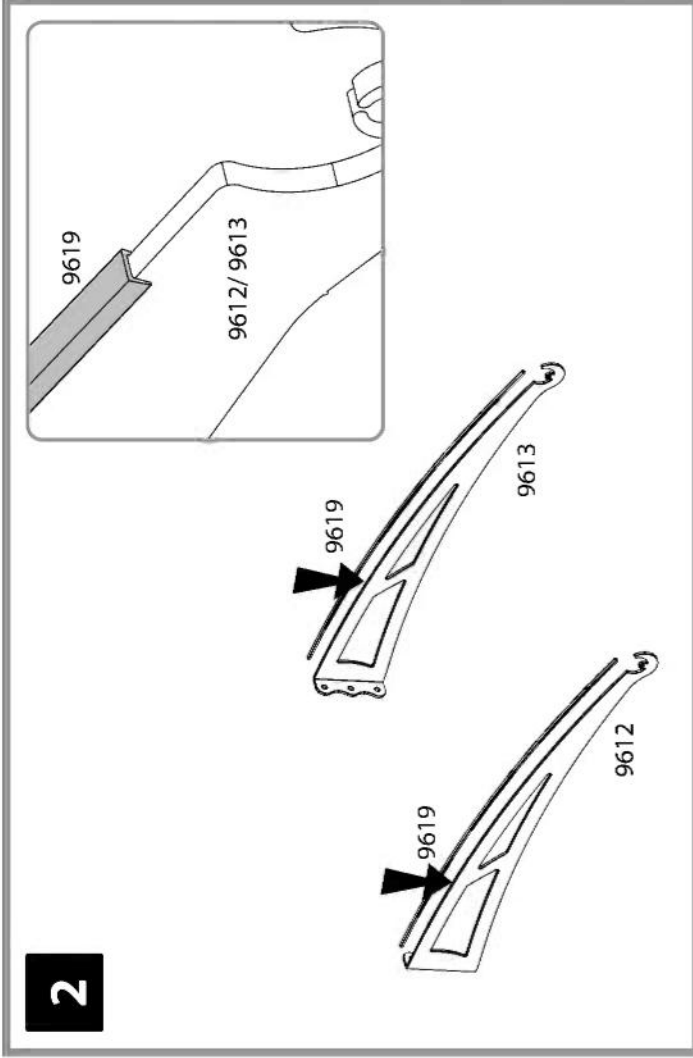
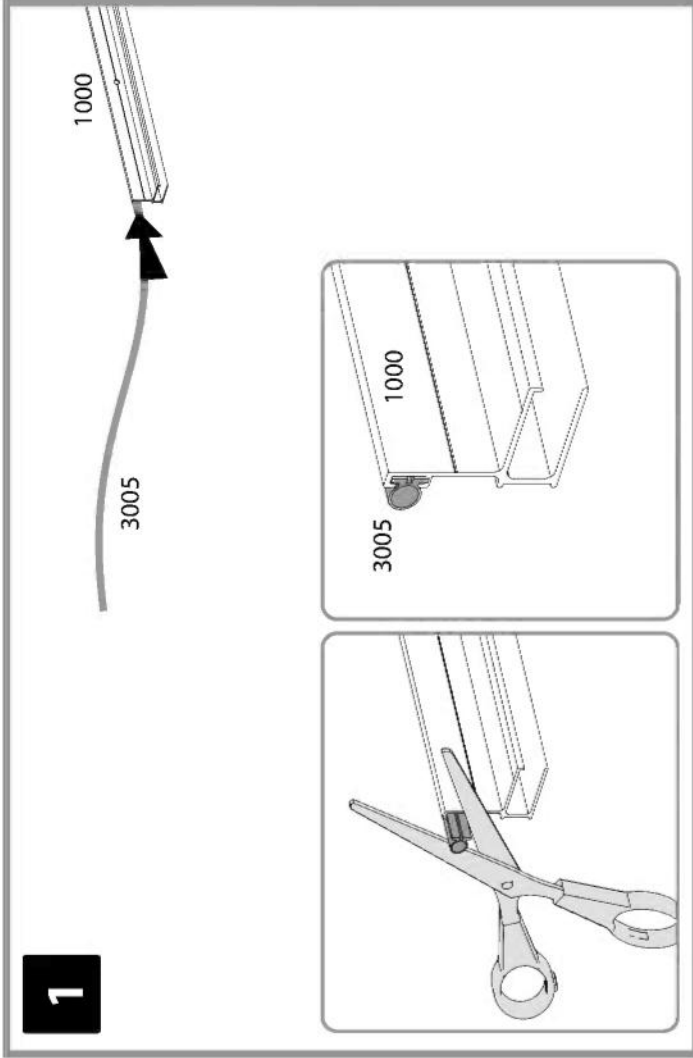

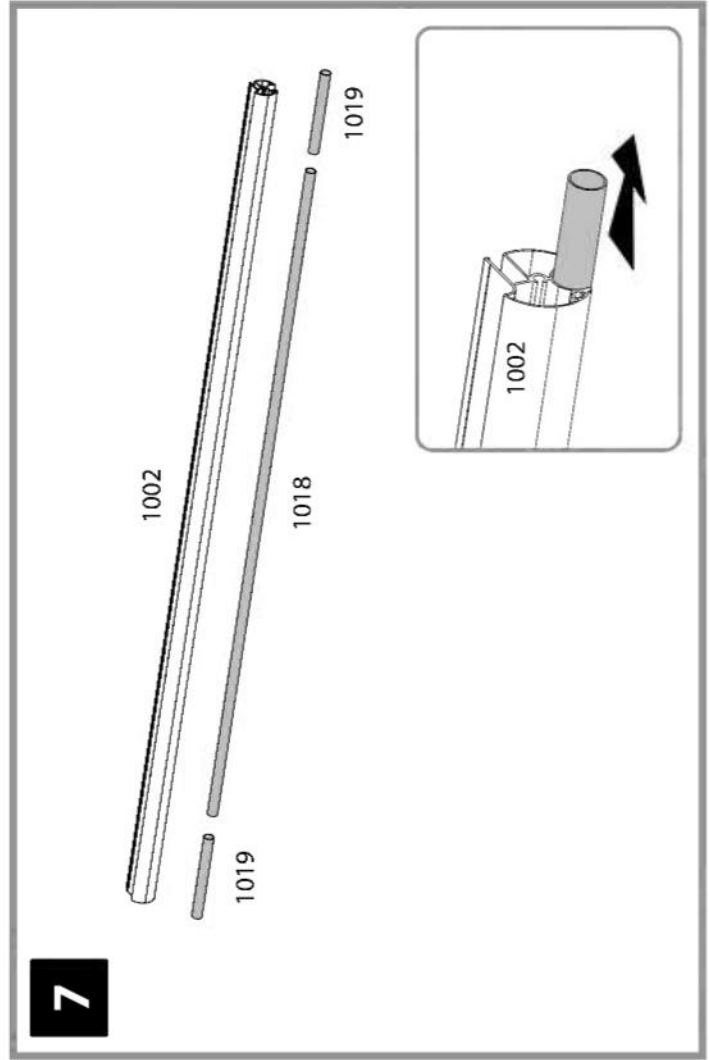
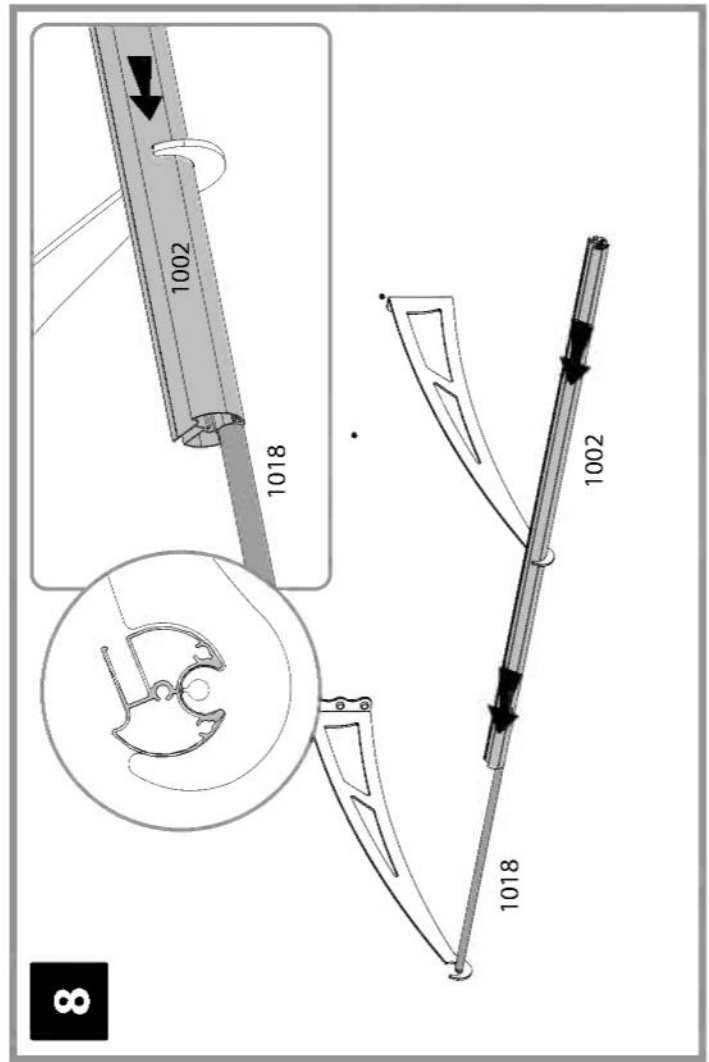
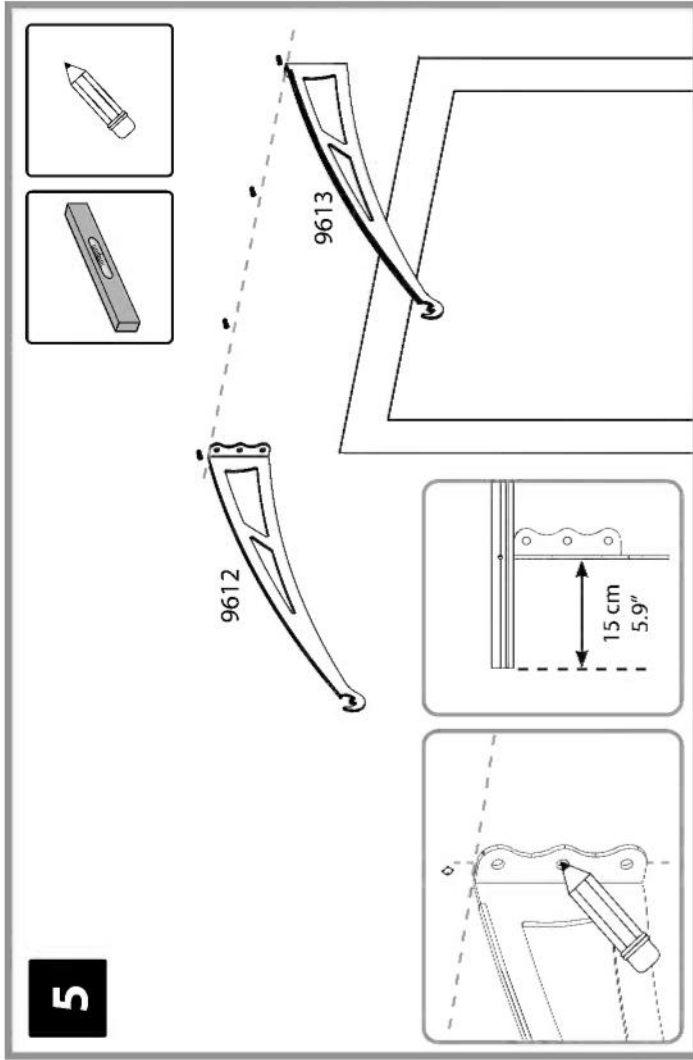
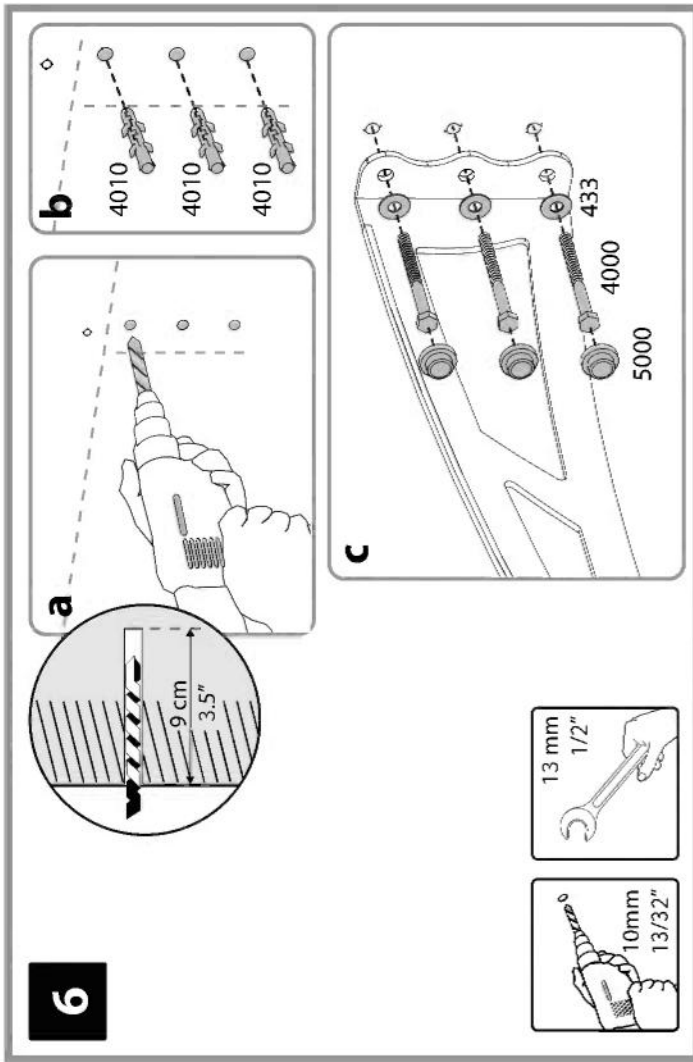

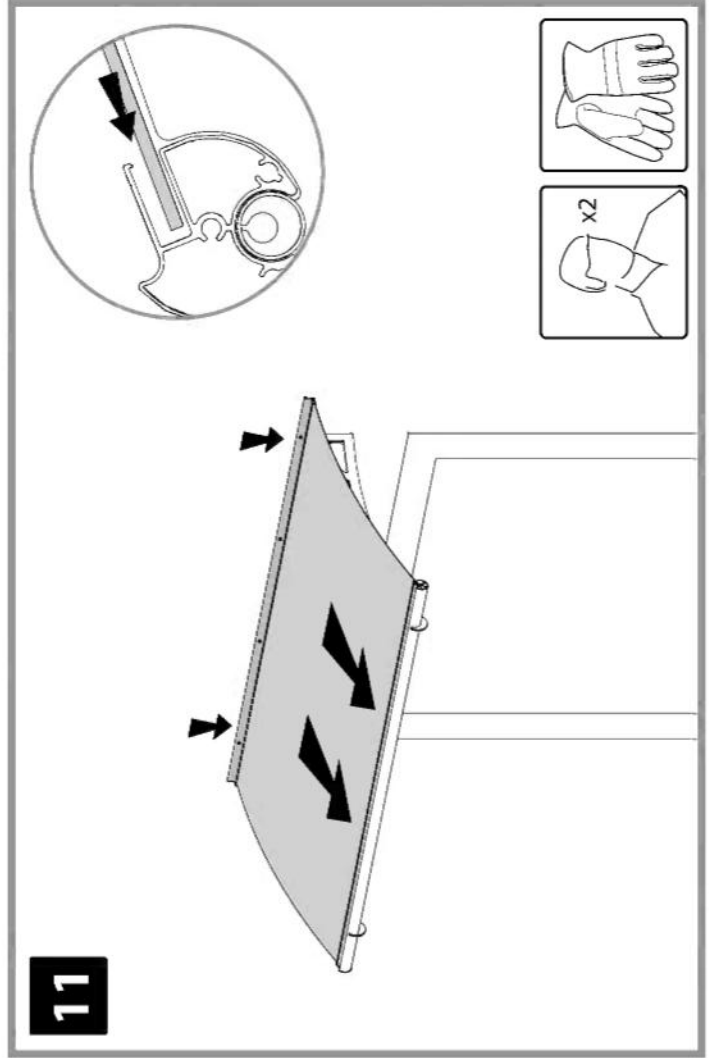
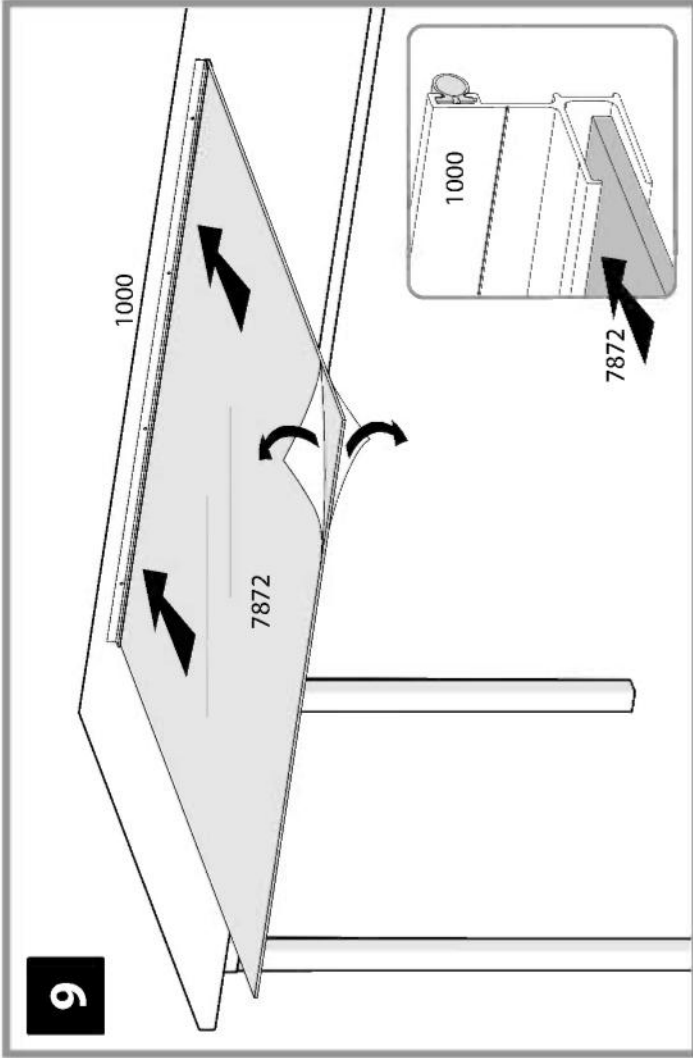
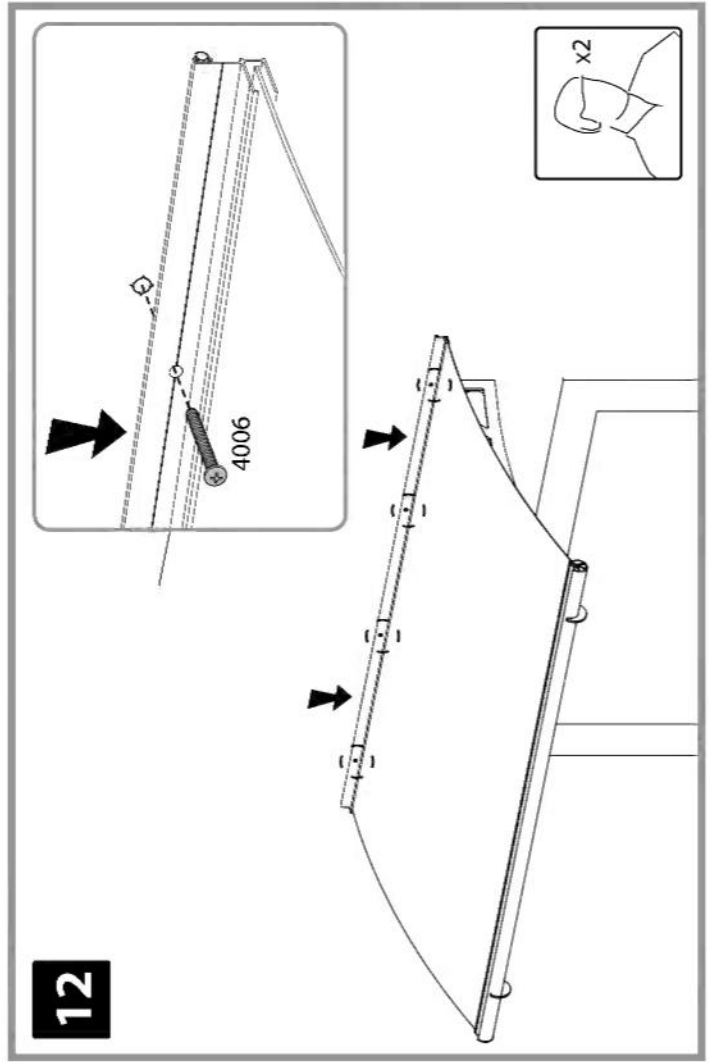
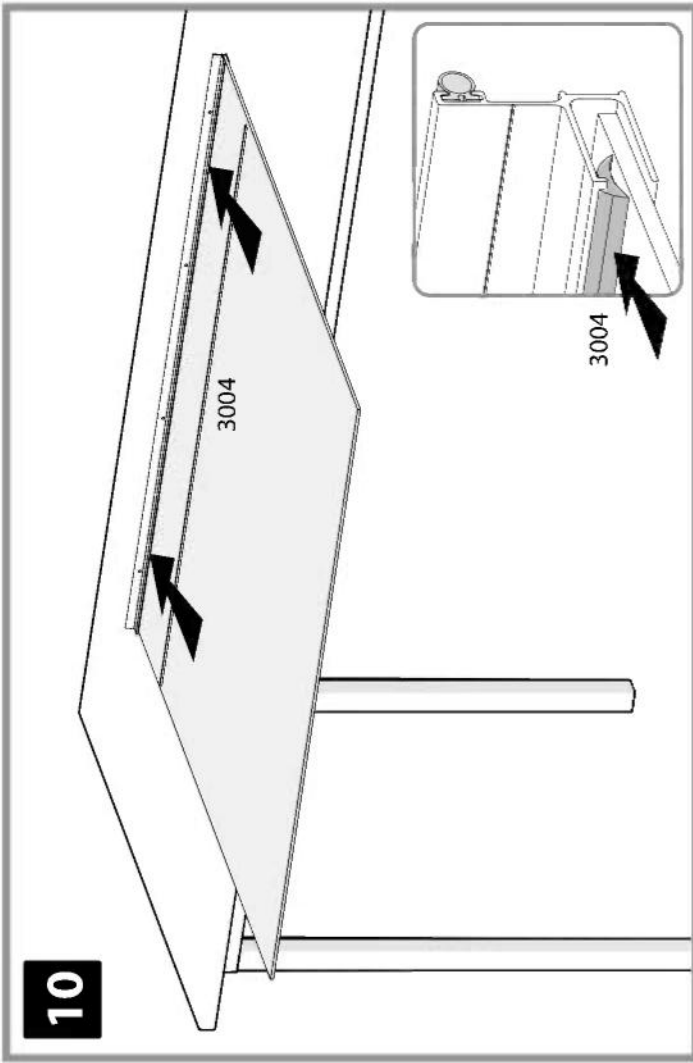

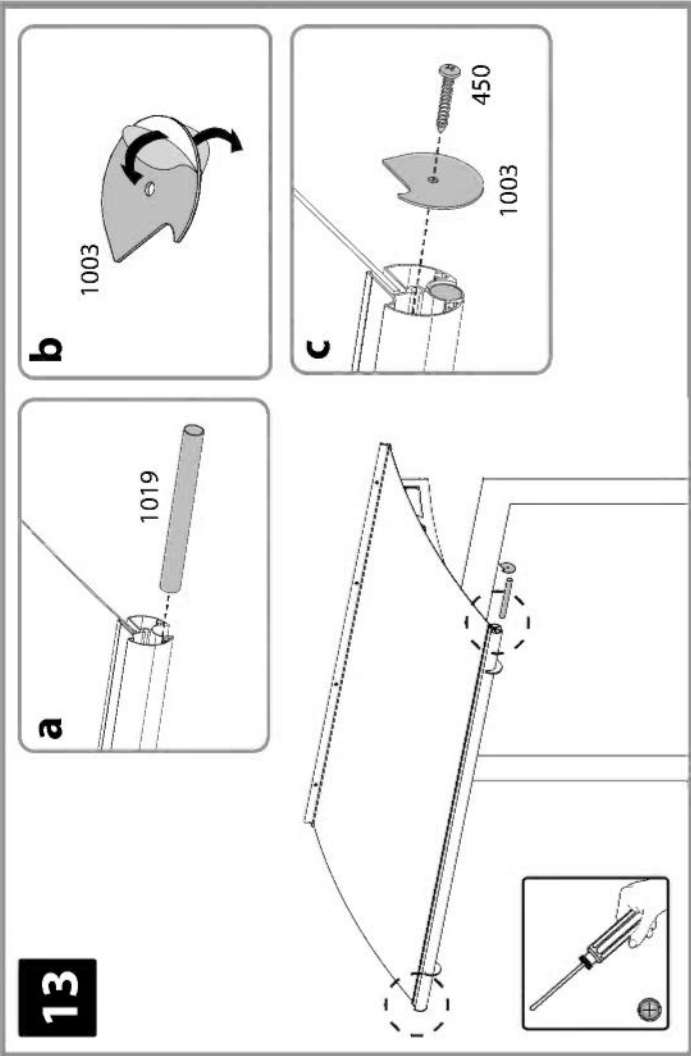
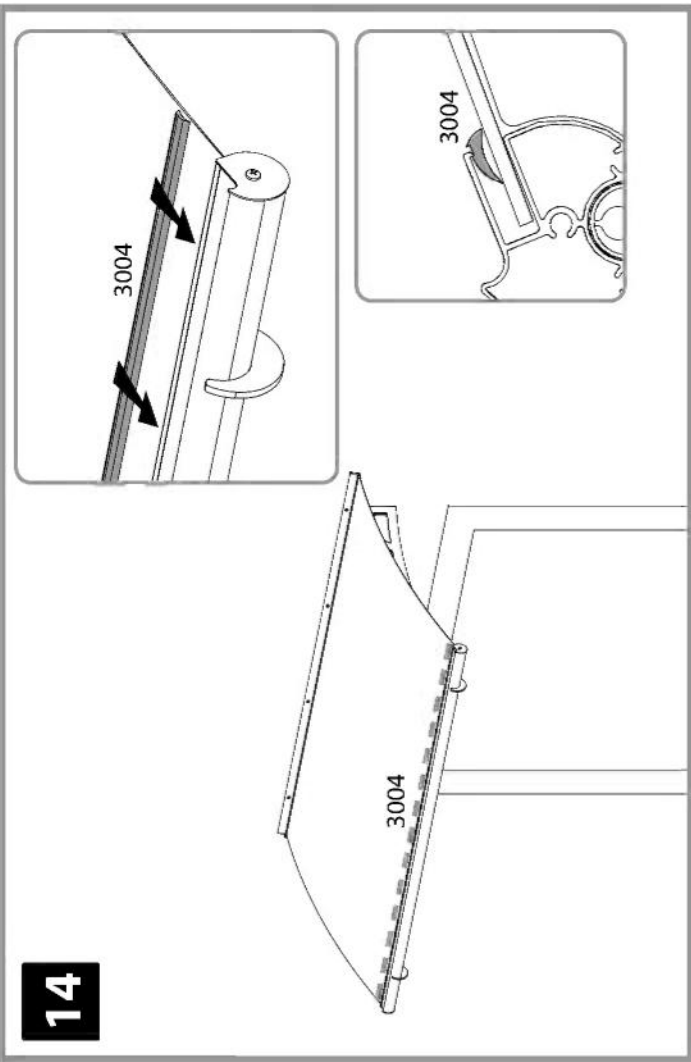

PALRAM - CANOPIA | 3 years Limited Warranty

Product Details: Canopia Canopy Door Cover

Palram Canopia Ltd (Company number: 512066824) whose registered office is at Teradon Industrial Park, M.P. Misgav 2074, Israel ("Canopia") warrants that the product will be free from defects in material or workmanship for a period of 3 years from the original date of purchase subject to the definitions, terms and conditions contained in this warranty.

- 1. Conditions**
- 1.1** This warranty shall be valid only if the product is installed, cleaned, handled and maintained in accordance with Canopia's written recommendations (Recommended Use: Hobby Gardening).
- 1.2** Without derogating from the above, damage caused by use of force, incorrect handling, inappropriate use, neglectful use or assembly or maintenance, accidents, impact from foreign objects, vandalism, pollutants, alteration, painting, connecting, drilling, sealing not in accordance with the user's manual, or damage resulting from cleaning with incompatible detergents and minor deviations of the product are not covered by this warranty.
- 1.3** This warranty does not apply to damage resulting from "force majeure", which includes but is not limited to, hail, storm, tornado, hurricane, blizzard, flood, fire effects.
- 1.4** This warranty is void if structural parts and components used are not compatible with Canopia's written recommendations.
- 1.5** This Warranty applies only to the original purchaser of the product. It does not extend to any other purchaser or user of the product (including, but not limited to, any person who acquires the product from the original purchaser).
- 1.6** Any other use for any other purpose is under user's sole responsibility. Canopia disclaims and assumes no liability for any use not recommended by this warranty.
- 2. Claims and Notifications**
- 2.1** Every warranty claim must be notified in writing to Canopia within 30 days after the discovery of the defective product, enclosing the original sales receipt and this warranty.
- 2.2** The claimant must allow Canopia to inspect the product involved and the installation site itself while the product is still in its original position and has not been removed or moved or altered in any way and/or return the product to Canopia for testing.
- 2.3** Canopia reserves the right to investigate independently the cause of any failure.

3. Compensation

- 3.1** If a claim under this Warranty is properly notified and approved by Canopia, the purchaser, at Canopia's option, may either (a) purchase a replacement product or parts or (b) receive refund of the original product or parts purchase price, all in accordance with the following schedule:

Period After Purchasing	Replacement Product or Parts	Refund
From date of purchase up to end of 1 st year	Free of charge	100%
End of 1 st Year up to end of 2 nd year	purchaser will pay 33% of the original purchase price	66%
End of 2 nd year up to end of 3 rd year	purchaser will pay 66% of the original purchase price	33%

- 3.2** For avoidance of any doubt, calculation for determination regarding compensation for defective parts, according to the schedule above, will be based on the contribution of the defective part to the original cost of the product. Canopia reserves the right to provide substitutions if the product or any part of it is unavailable or obsolete.
- 3.3** This warranty does not cover any costs and expenses of removal and installation of the product or taxes or shipping cost or any other direct or indirect cost(s) which may result from the product failure.

4. General Conditions and Limitations

- 4.1** OTHER THAN HAS BEEN SPECIFICALLY STATED IN THIS WARRANTY, ALL OTHER WARRANTIES, WHETHER EXPRESS OR IMPLIED, INCLUDING ALL IMPLIED WARRANTIES OF MERCHANTABILITY OR FITNESS FOR A PARTICULAR PURPOSE ARE EXCLUDED SO FAR AS THE LAW PERMITS.
- 4.2** EXCEPT WHERE WE HAVE SPECIFICALLY STATED IN THIS WARRANTY, CANOPIA SHALL NOT BE LIABLE FOR ANY LOSSES OR DAMAGES THE PURCHASER SUFFERS DIRECTLY, INDIRECTLY, OR AS A CONSEQUENCE OF USING, OR IN ANY OTHER WAY CONNECTED TO THE PRODUCT.
- 4.3** IF CANOPIA IS PROHIBITED UNDER ANY APPLICABLE LAW FROM EXCLUDING THE IMPLIED WARRANTIES OF MERCHANTABILITY OR FITNESS FOR A PARTICULAR PURPOSE IN RELATION TO THE PRODUCT, THE DURATION OF ALL SUCH IMPLIED WARRANTIES IS EXPRESSLY LIMITED TO THE DURATION OF THIS WARRANTY OR, IF LONGER, THE MAXIMUM PERIOD REQUIRED BY APPLICABLE LAW.
- 4.4** THE PURCHASER IS SOLELY RESPONSIBLE FOR DETERMINING WHETHER THE HANDLING, STORAGE, ASSEMBLY, INSTALLATION OR USE OF THE PRODUCT IS SAFE AND APPROPRIATE IN ANY LOCATION, FOR ANY GIVEN APPLICATION OR IN ANY GIVEN CIRCUMSTANCE. CANOPIA IS NOT RESPONSIBLE FOR ANY DAMAGES OR INJURY TO THE PURCHASER, ANY OTHER PERSON OR ANY PROPERTY RESULTING FROM THE IMPROPER HANDLING, STORAGE, INSTALLATION, ASSEMBLY OR USE OF THE PRODUCT OR THE FAILURE TO FOLLOW THE WRITTEN INSTRUCTIONS REGARDING THE HANDLING, STORAGE, INSTALLATION, ASSEMBLY AND USE OF THE PRODUCT.
- 4.5** UNLESS OTHERWISE EXPRESSLY INDICATED BY CANOPIA, THE PRODUCT IS INTENDED FOR NORMAL RESIDENTIAL AND COMMERCIAL USE ONLY. CANOPIA IS NOT RESPONSIBLE FOR ANY LOSS, DAMAGE, COST OR EXPENSE RESULTING FROM ANY USE OF THE PRODUCT FOR ANY PURPOSE THAT IS NOT RECOMMENDED BY THE WRITTEN INSTRUCTIONS OR THAT IS NOT PERMITTED BY ANY APPLICABLE LEGISLATION OR OTHER CODES IN EFFECT IN THE LOCATION WHERE THE PURCHASER WILL USE THE PRODUCT.
- 4.6 PLEASE NOTE:** ANCHORING THIS PRODUCT TO THE GROUND IS ESSENTIAL TO ITS STABILITY AND RIGIDITY. IT IS REQUIRED TO COMPLETE THIS STAGE IN ORDER FOR YOUR WARRANTY TO BE VALID.

DE 3 Jahre beschränkte Garantie von PALRAM - CANOPIA

Angaben zum Produkt: Canopia Vordach - Türvordach

Palram Canopia Ltd (Firmennummer: 512066824) mit Sitz in Teradon Industrial Park, M.P. Misgav 2074, Israel ("Canopia") garantiert, dass das Produkt für einen Zeitraum von 3 Jahren ab dem Kaufdatum frei von Mängeln in Material und Verarbeitung wird, und den Definitionen, Begriffen und Bedingungen die in dieser Garantie enthalten sind unterliegt.

1. Bedingungen

- 1.1** Diese Garantie ist nur gültig, wenn das Produkt in Übereinstimmung mit den schriftlichen Empfehlungen von Canopia installiert, gereinigt, behandelt und gepflegt ist. (Empfohlene Verwendung: Hobby Gärtnerei).
 - 1.2** Ohne Abweichung von oben genannten Schäden, die durch Anwendung von Gewalt, unsachgemäße Behandlung, unsachgemäße Verwendung, nachlässige Nutzung, Montage oder Wartung, Unfälle, Auswirkungen von Fremdkörpern, Vandalismus, Verschmutzung, Veränderung, Moleure, Verbinden, Kleben und Dichten, nicht in Übereinstimmung mit der Bedienungsanleitung, verursacht werden, oder Schäden, die bei Reinigung mit inkompatiblen Reinigungsmitteln entstehen, so wie geringfügige Abweichungen des Produkts, werden durch diese Garantie nicht abgedeckt.
 - 1.3** Diese Garantie gilt nicht für Schäden, die durch "höhere Gewalt" verursacht werden (beinhalten aber nicht beschränkt auf: Hagel, Sturm, Tornado, Hurrikan, Schneesturm, Überschwemmungen, Feuer Auswirkungen).
 - 1.4** Diese Garantie erlischt, falls Bauteile und Komponenten, die nicht mit den schriftlichen Empfehlungen von Canopia kompatibel sind, verwendet werden.
 - 1.5** Diese Garantie gilt ausschließlich für den ursprünglichen Käufer des Produkts. Sie erweitert sich nicht auf keine anderen Käufer oder Benutzer des Produkts (einschließlich, aber nicht beschränkt auf irgendeine andere Person die das Produkt von den ursprünglichen Käufer erwirbt).
 - 1.6** Jede andere Verwendung, für einen anderen Zweck liegt in der alleinigen Verantwortung des Benutzers.
- Canopia lehnt jede Haftung ab, die von dieser Garantie nicht gedeckt wird, bzw. übernimmt keine Haftung dafür.

2. Ansprüche und Mittelungen

- 2.1** Jeder Gewährleistungsanspruch muss Canopia innerhalb von 30 Tagen nach Entdeckung des fehlerhaften Produkts schriftlich vorgelegt werden. Hier zu sehen Sie bitte auch den Original-Kaufbeleg und diese Garantie mit ein.
- 2.2** Der Antragsteller muss Canopia erlauben den betroffenen Produkt und den Aufstellungsort selbst, zu überprüfen, während das Produkt noch in seiner ursprünglichen Position ist und nicht entfernt oder verschoben oder in irgendeiner Weise verändert wurde, und/oder den Produkt an Canopia zum Testen zu senden.
- 2.3** Canopia behält sich das Recht vor die Fehlersachen unabhängig zu untersuchen.

3. Entschädigung

- 3.1** Ist ein Anspruch gemäß dieser Garantie ordnungsgemäß angemeldet und bei Canopia genehmigt worden, kann der Käufer, nach eigenem Ermessen von Canopia, entweder (a) ein Ersatzprodukt oder Teile erwerben oder (b) eine Ersatzung des ursprünglichen Produkt oder Teile Kaufpreises erhalten, alles in Übereinstimmung mit dem folgendem Schema:

Zeitraum nach Erwerbung	Ersatzprodukt bzw. Ersatzteile	Rückerstattung
Ab Kaufdatum bis zum Ende des 1. Jahr	Kostenlos	100%
Ende des 1. Jahr bis zum Ende des 2. Jahr	Käufer zahlt 33% des ursprünglichen Kaufpreises	66%
Ende des 2. Jahr bis zum Ende des 3. Jahr	Käufer zahlt 66% des ursprünglichen Kaufpreises	33%

- 3.2** Um jegliche Zweifel auszuschließen, wird sich die Berechnung für die Bestimmung über Entschädigungen für defekte Teile, entsprechend der obigen Schema, auf dem Betrag des defekten Teils an den ursprünglichen Kosten des Produktes beruhen. Canopia behält sich das Recht vor für ein Ersatz zu sorgen, falls der Produkt oder ein Teil davon nicht verfügbar oder veraltet ist.

- 3.3** Diese Garantie erstreckt sich nicht auf Kosten und Ausgaben für Aus- und Einbau des Produkts oder Steuern oder Versandkosten oder sonstige direkte oder indirekte Verluste die sich von einem Produktfehler ergeben können.

4. Allgemeine Bedingungen und Einschränkungen

- 4.1** ANDERS ALS BESONDERS IN DIESER GARANTIE ANGEZEIGEN, ALLE ANDEREN GARANTIE, OB AUSDRÜCKLICH ODER IMPLIZIT, EINSCHLIESSLICH ALLER ENGESCHLOSSENEN GARANTIELEISTUNGEN DER MARKTGÄNGIGKEIT ODER EIGNUNG FÜR EINEN BESTIMMTEN ZWECK SIND SO WEIT DIES RECHTLICH MÖGLICH IST AUSGESCHLOSSEN.
- 4.2** AUSSER ALS AUSDRÜCKLICH IN DIESER GARANTIE ANGEZEIGEN, HÄFTET CANOPIA NICHT FÜR IRGENDWELCHE VERLUSTE ODER SCHÄDEN DIE DER KÄUFER, DIREKT ODER INDIRECT ODER ALS FOLGE DER NUTZUNG ODER IN IRGENDWELCHEN ANDEREN MIT DEM PRODUKT VERBUNDENEN WEBELEBET.
- 4.3** FALLS CANOPIA EIN AUSSCHLUSS DER STILLSCHWENGEN GARANTIE DER MARKTGÄNGIGKEIT ODER EIGNUNG FÜR EINEN BESTIMMTEN ZWECK IN BEZUG AUF DAS PRODUKT NACH GELTENDEM RECHT NICHT GESTATET IST, WIRD DIE DAUER ALLER SOLCHEN GARANTIE AUSDRÜCKLICH AUF DIE DAUER DIESER GARANTIE BESCHRÄNKT, ODER FALLS LÄNGER, AUF DIE GEGENZÜGLICH VORGESCHRIEBENE HÖCHSTDAUER.
- 4.4** DER KÄUFER IST ALLEN DAFÜR VERANTWORTLICH FESTZUSTELLEN, OB DIE HANDHABUNG, LAGERUNG, MONTAGE, INSTALLATION ODER VERWENDUNG DES PRODUKTS AN BELIEBIGEN STANDORT UND FÜR JEDE GEGEBENE ANWENDUNG ODER SITUATION, SICHER UND ANGEMESSEN IST. CANOPIA IST NICHT VERANTWORTLICH FÜR SCHÄDEN ODER VERLETZUNGEN DES KÄUFERS, ANDERER PERSONEN ODER DES EIGENTUMS, DIE IN FOLGE EINER UNSACHGEMÄSSEN HANDHABUNG, LAGERUNG, EINBAU, MONTAGE ODER NUTZUNG DES PRODUKTS ODER DURCH NICHTBEACHTUNG DER ANWEISUNGEN ZUR HANDHABUNG, LAGERUNG, EINBAU, MONTAGE UND NUTZUNG DES PRODUKTES ENTSTANDEN SIND.
- 4.5** DIE WARE IST BESTIMMT AUSSCHLIESSLICH ZUR NORMALEN PERSÖNLICHEN UND KOMMERZIELLEN NUTZUNG, SOFERN NICHT AUSDRÜCKLICH ETWAS ANDERES DURCH CANOPIA VERBIBART WURDE. CANOPIA HÄFTET NICHT FÜR VERLUSTE, SCHÄDEN, KOSTEN ODER AUSGABEN, DIE AUS EINER NICHT VON DEN ANWEISUNGEN EMPFOHLENE VERWENDUNG DES PRODUKTS ZUR IRGENDWELCHEM ZWECK ENTSTEHEN ODER DIE VON KEINEM GELTENDEN RECHTSVORSCHRIFTEN ODER ANDEREN CODES ERLAUBT SIND DIE AN DEM ORT WO DER KÄUFER DEN PRODUKT BENUTZEN WIRD IN KRFT SIND.
- 4.6** DIE VERKÄUFER DIESER GARANTIE IM ÜBERGRUND IST WESENTLICH KIR SEINE STABILITÄT UND FESTIGKEIT. SIE IST UNABSLÄSSLICH, URN DISEN ARBEITSSCHRITT ZU BEENDEN, DAVIT IHRE GARANTIE GÜLTIG BLEIBT.

Declaration of Performance

According to Construction Products Council Directive UE N°305/2011 and EN 14963:2006

Issue Date 01/01/2022

1. Identification code: **Aquila™, refer to CE label no 003**
2. Type: A light transmitting wall-supported 4 mm thickness solid PMMA extruded sheets structure made of aluminum and galvanized steel elements
3. Intended use: open multi-purpose covering
4. Manufacturer: Palram Canopia Ltd. Teradion Industrial Park, M.P Misgav 2017400, P.O.B. 53, Israel
5. Importer and EU representative : PALRAM Applications UK, Unit 40 J3 Industrial Estate Carr Hill, Doncaster DN4 8DE
6. Assessment and verification of constancy of performance: System 3
7. Declared performance:

Resistance to upward load: UL 500

Resistance to downward loads: DL 1000

Reaction to fire: B, s1, d0

For mounting and fixing provisions see EN 16153:2013

Resistance to fire: NPD

External fire performance: F_{ROOF}

Water tightness:

For the rooflight with upstand: Pass

For the sheet material: Pass

Impact resistance:

For the small hard body: Pass

For the large soft body: Pass

Thermal transmittance:

For the rooflight: NPD (not relevant to an open multi purpose cover)

For the sheet material: 5.86 W/(m²·K)

Direct airborne sound insulation: NPD (not relevant to an open multi purpose cover)

Radiation transmittance:

- Light transmittance: Tv - 93.0 %

- Solar direct transmittance: Te - 81.83 %

- Solar factor: g value - 0.85

Air permeability:

For the rooflight: NPD (not relevant to an open multi purpose cover)

For the sheet material: Pass

Durability (of the sheet material): ΔA, Cu 1, Ku 0

The performance of the product identified in points 1 and 2 is in conformity with the declared performance in point 7.

This declaration of performance is issued, in accordance with Annex ZA.2.2 – EN 14963:2006,

under the sole responsibility of Palram Canopia Ltd.

ITT reports and Factory Production Control records are available upon request at www.canopia.com

Signed for and behalf of Palram Canopia Ltd. by:

Teradion Industrial Park, Misgav, 01/01/2022

