



OUTDOOR STORAGE

MODEL N° 60014

OWNER'S MANUAL

Keep this Identification Number in case you must contact our Customer Service Department.

IMPORTANT! PLEASE READ BEFORE BEGINNING ASSEMBLY

Dear Valued Customer,

We would like to congratulate you on your purchase of a Lifetime® Outdoor Storage Shed! We are confident that you have made the perfect choice and you will be very pleased with your new storage solution.

Lifetime® Outdoor Storage is part of the family of products created and manufactured by Lifetime® Products, Inc. Like all of our products, you can be assured that the quality of your Lifetime Outdoor Storage Shed is the best in the world! And, we back that quality up by offering the best warranty in the business – A 10-year warranty that fully covers the Shed!

All of our Sheds are built with the highest-quality steel and high-density polyethylene (HDPE) parts. The design and construction of our steel-reinforced double-Wall Panels is second to none. All of our exposed steel parts and gables are powder coated and we use high-density polyethylene plastic. What makes polyethylene so special? It has superior strength and durability, and, it won't crack or degrade outdoors.

So now that you know the quality you are getting in a Lifetime Outdoor Storage Shed, please take the time to **READ THIS INSTRUCTION MANUAL!**

We have taken great care in providing the best possible form of instructions to help you put your new Outdoor Storage Shed together. Before you get started, **PLEASE** read the following preparation tips to help you get started!

We can assure you, your construction experience will be a lot more enjoyable if you do!

PREPARATION TIPS:

- The first step is simple... **RELAX!** You have made a great purchase, but Rome was not built in a day. Plan to spend a good part of your weekend putting together your fine Outdoor Storage Shed. Our philosophy is, if it comes together quickly and easily, it surely will come apart quickly and easily! Your Lifetime® Outdoor Storage Shed will surely last a long, long time, if you are patient, and take all the time necessary to put it together as we have instructed.
- Grab a friend to join in on the fun! This is not a one-person endeavor. We have found that not only will things go smoother if you have two or more people participating in the construction of the Shed, but it will go quicker as well. So, the more the merrier!
- Make sure you have all the tools necessary for constructing your new Shed. There is a "Tools Required For This Assembly" list on page five of this Owner's Manual.
- The plastic pieces of your Shed may become damaged by over tightening the screws. To avoid this damage, we strongly recommend the use of a low-powered power screwdriver or a drill that has an adjustable clutch that is set on a low-torque setting. If neither is available, use a hand screwdriver. If a hand screwdriver is all you have, take several breaks... your wrist will need it!
- You will also need two small ladders (when it comes time to do the roof!).

IMPORTANT! PLEASE READ BEFORE BEGINNING ASSEMBLY

- Before beginning assembly, remove the Parts List from the center of this Owner's Manual and take an inventory of the parts included with your Outdoor Storage Shed. Also, read through the entire instruction manual. It's always a great practice to get a feel for the flow of the process and to familiarize yourself with the parts involved. But, try not to get ahead of yourself and start the process out of order.
- **FOLLOW THE INSTRUCTIONS IN ORDER!** Everything goes together in a certain order, and we have learned what that correct order should be. In our state-of-the-art research and testing facility, we have painstakingly created these instructions. The order of construction is there for a reason, and some parts simply will not fit if built out of order. Just follow along with the order in the instructions and everything will fit together and things will go very smooth.
- **YOUR SHED MUST BE BUILT ON A LEVEL SURFACE!** If the spot you have chosen to place your wonderful new Outdoor Storage Shed is not level, the Shed will not assemble correctly! We recommend a concrete patio, a wood platform or creating a pad with pea gravel. Your Shed is meant to last a lifetime, so provide the proper foundation for it before you start to build.
- Before you build it, make sure you are allowed to build it! Consult all building codes, as well as city and county ordinances, to ensure that you do not require a building permit to construct your Outdoor Storage Shed. Proper building permit documentation may be required in your neighborhood, and it would be quite unfortunate to learn this after your Outdoor Storage Shed is already built!

Now that you're ready to begin the construction of your wonderful new Outdoor Storage Shed, step back, take a deep breath, get yourself a large cold beverage and enjoy yourself. We guarantee that after spending the right amount of time in building your Shed, you will be able to enjoy it for years to come.

Thanks for choosing Lifetime®, and have fun!

ABOUT LIFETIME PRODUCTS, INC.

Lifetime Products, Inc., has applied innovation and cutting-edge technology in plastics and metals to create a family of affordable lifestyle products that feature superior strength and durability. The world's leading manufacturer of folding tables and chairs, Lifetime was founded in 1986 as the maker of portable basketball systems that revolutionized the industry with patented technology. With diverse offerings such as outdoor storage sheds and steel utility trailers, Lifetime continues to develop innovative products that outfit the way you live.

Lifetime makes the things you need for the lifestyle you want. By innovating products in and around the home, Lifetime simplifies your everyday life and enables you to get the most out of your free time.



REGISTER YOUR LIFETIME PRODUCT TODAY!

There are benefits to registering your Lifetime product. With our new online product registration form, it's fast and easy! Register with us at www.lifetime.com and enjoy these great benefits:

- Receive exclusive money-saving offers from BuyLifetime.com, our online store, as well as NEW product notifications and special closeout promotions!
- In the unlikely event of a product recall or safety modification, we will notify you.
- Registering your product guarantees you warranty service. If you do not register your product, your warranty rights will not be diminished. But you will need to provide a sales receipt to verify your product purchase date before warranty service will be provided.

LIFETIME'S PROMISE TO YOU:

Maintaining your privacy is our long-standing policy at Lifetime. And you can rest assured that Lifetime will not sell or provide your personal data to other third parties, or allow them to use your personal data for their own purposes.

We invite you to read our privacy policy at www.lifetime.com

REGISTER today!

****U.S. and Canada customers ONLY****

IF ASSISTANCE IS NEEDED,

DO NOT CONTACT THE STORE!

CALL OUR CUSTOMER SERVICE DEPARTMENT at 1 (800) 225-3865

HOURS: 7:00 a.m. to 5:00 p.m. Monday through Friday (Mountain Standard Time)

Call, or visit our Web site for Saturday hours

For customers outside the U.S. or Canada, please contact the store for assistance.



SAFETY INSTRUCTIONS



FAILURE TO FOLLOW THESE WARNINGS MAY RESULT IN SERIOUS INJURY OR PROPERTY DAMAGE AND WILL VOID WARRANTY.

To ensure safety, do not attempt to assemble this product without following the instructions carefully. Check entire box and inside all packing material for parts and/or additional instruction material. Before beginning assembly, read the instructions and identify parts using the hardware identifier and parts list in this document. Proper and complete assembly, use and supervision are essential to reduce the risk of accident or injury.

- Do not use or store hot objects such as grills, blowtorches, welding equipment, etc. near the product.
- If using a ladder during assembly, use extreme caution.
- Two capable adults are required for assembly. (It is also recommended that a third adult function as an instruction reader.)

Most injuries are caused by misuse and/or not following instructions. Use caution when using this product.

BEFORE BEGINNING ASSEMBLY



Keep the hardware bags and their contents separate. If any parts are missing, call our Customer Service Department.

Read the "Congratulations" letter on page 2-3. Identify and inventory all parts and hardware using the parts and hardware lists and identifiers in this document.



****Two adults required to complete assembly****
(+ one adult suggested as an instruction reader)

Only adults should set up the product. Do not allow children in the set-up area until assembly is complete.



TOOLS REQUIRED FOR THIS ASSEMBLY

7/16"	3/8"	Adjustable	Rubber Mallet	Box Knife	Phillips Screwdriver	Plain Screwdriver	3/8" Masonry Bit	2" x 4" x 7' Leveling Board
(2)	(1)	(1)	(1)	(1)	(1)	(1)	(1)	
6' Ladder	Power Drill*	Work Light	Pliers	Flashlight	Hammer Drill*	Safety Glasses	Sheet of Wax Paper	
(2)	(1)	(1)	(1)	(1)	(1)	(1 for each person)	(1)	(1)

*See "Screwdriver Notice" on page 7.

ASSEMBLY GUIDES

Refer to the following areas throughout the instructions to assist in the assembly process:

This area is located at the top, left-hand corner of the page and indicates which tools and hardware are needed to complete the assembly steps on a page.



TOOLS AND HARDWARE REQUIRED FOR THIS PAGE



This area is located at the top, right-hand corner of the page and shows an image of the product with shaded parts indicating which section is being assembled.



This area is usually located in the bottom, left-hand corner of a step and indicates that special attention is needed to perform a particular part of a step.



Note:

These areas are usually located in the bottom, right-hand corner of a step and indicate that damage to the product or serious injury may occur if the caution or warning is not heeded.



CAUTION



WARNING

Throughout the Parts & Hardware List, Part & Hardware Identifiers, and instructions are three-letter IDs. These IDs are below the images of the parts and hardware to help you locate and identify the parts and hardware during assembly. These IDs are not necessarily on the parts themselves.

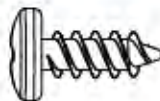

ADZ (x10)
1/4" x 5/8" Pan-Head Screw

IMPORTANT NOTICES

Level Surface Notice:

Surface must be leveled before installation. We recommend building a level work space with a concrete or patio style surface. If the surface is not properly leveled, the Outdoor Shed will not assemble correctly. Proper surface leveling will save you time in the long run, so please do not ignore this step.

Building Code Notice:

Consult all local building codes, as well as city and county ordinances, to ensure that the construction of the Outdoor Shed does not require a building permit. Proper building permit documentation may be required in your neighborhood, and it would be unfortunate to learn this after constructing the Shed.

Screwdriver Notice:

You may use a #2 Phillips head screwdriver bit and a power screwdriver or drill, instead of a hand screwdriver. However, be aware that the plastic pieces of your Shed can be damaged by overtightening of screws. To avoid damage we strongly recommend the use of a low-powered power screwdriver or a drill that has an adjustable clutch that is set on a low torque setting. If neither is available, use a hand screwdriver. In any case use caution to avoid overtightening the screws.

Floor Puncture Notice:

Sharp objects may damage your floor. If resting sharp, heavy objects on your Shed floor, place a block of wood between the sharp object and floor.

CAUTION:

If more than six (6) inches of snow accumulate on the roof of the shed, carefully remove the snow to avoid possible roof collapse. While standing on the ground, remove the snow from the roof with a broom or snow shovel. Do not stand on the roof to remove snow.

PARTS & HARDWARE LIST

BOX 1

ID	Description	Qty
AGR	Outer Floor Panel	2
AFX	Center Floor Panel	1
AHD	Wall Panel	5
AHH	Window Wall Panel	1
AGQ	Roof Panel	2
AGL	Corner Wall Panel	1
AHE	Window	1
BYU SMALL PARTS BOX		
BYW	Roof End Cap	2
BYX	Roof End Cap Filter	4
BYY	Roof Support Tube	6
BZC	Tube of Caulking	1
AIX	Wood Shim	4
AIW	Wood Block	1
BYC FLOOR ASSEMBLY HARDWARE		
BQC	#8 x 1/2" Pan-Head Screw	4
AHO	Door Hinge Bushing	2
ADC	#2 Phillips Bit	1
BYE WALL INSTALLATION HARDWARE		
ADZ	1/4" x 5/8" Pan-Head Screw	80
ADV	1/4" x 1 1/8" Pan-Head Screw	6
BYD TRUSS ASSEMBLY HARDWARE (x2)		
ADY	#10 x 3/8" Pan-Head Screw	12
ADK	#10 Cap Nut	12
ADJ	1/4" Cap Nut	2
BXU	Truss Connector A	1
BXV	Truss Connector B	1
BXW	Truss Connector Bracket	1
ADH	1/4" Threaded Rod	1
BYF GABLE ASSEMBLY HARDWARE		
ADZ	1/4" x 5/8" Pan-Head Screw	3
ADV	1/4" x 1 1/8" Pan-Head Screw	6
BYG WINDOW INSTALLATION HARDWARE		
ADZ	1/4" x 5/8" Pan-Head Screw	2
AIS	Window Latch Bracket	1
BYI DOOR & ENTRY GABLE INSTALLATION HARDWARE		
ADZ	1/4" x 5/8" Pan-Head Screw	17
AHP	Cotter Pin	2
BFY	1/4" x 3/4" Pan-Head Screw	5
ADJ	1/4" Cap Nut	5
BXZ	1/4" Nylon Washer	16
ADX	#10 x 1/2" Pan-Head Screw	2
BYM	Strike Plate	1
BYK RIGHT DOOR ASSEMBLY HARDWARE		
BYS	Outer Door Handle	1
BYR	Inner Door Handle	1
BYZ	#10 x 1 3/4" Pan-Head Screw	2
ADW	#10 x 3/4" Pan-Head Screw	1
AEE	#10 x 1/2" Flat Washer	1
BBI	Inside Door Handle	1
CHK	#10 x 3/4" Self-Drilling/Self-Tapping Screw	1
CIF	End Cap	1

ID	Description	Qty
BYJ LEFT DOOR ASSEMBLY HARDWARE		
BYS	Outer Door Handle	1
BYR	Inner Door Handle	1
BYZ	#10 x 1 3/4" Pan-Head Screw	2
ADW	#10 x 3/4" Pan-Head Screw	5
AEE	#10 x 1/2" Flat Washer	7
BZB	#10 x 1/4" Nylon Spacer	4
BYP	Deadbolt Latch Bracket	2
BYQ	Deadbolt Latch	2
CHK	#10 x 3/4" Self-Drilling/Self-Tapping Screw	1
CIF	End Cap	1
ARA	1/8" Drill Bit	1
BYL TRUSS, REAR GABLE, & ROOF INSTALLATION HARDWARE		
ADZ	1/4" x 5/8" Pan-Head Screw	91
BYT	Gable-to-Roof Clip	16
ADV	1/4" x 1 1/8" Pan-Head Screw	24
CVP LATCH INSTALLATION HARDWARE		
ACA	1/4" x 1/2" Carriage Bolt	3
AEB	1/4" Flat Washer	3
ADX	#10 x 1/2" Pan-Head Screw	9
AEE	#10 Flat Washer	9
AAB	1/4" Centerlock Nut	3
CHK	#10 x 3/4" Self-Drilling/Self Tapping Screw	2
CVW	Door Latch	1
CVT	Left Door Latch Bracket	1
CVU	Large Right Door Latch Bracket	1
CVV	Small Right Door Latch Bracket	1
CVS	Left Door Latch Cover	1
CVR	Small Right Door Latch Cover	1
CVQ	Large Right Door Latch Cover	1

BOX 2

AGQ	Roof Panel	4
AGL	Corner Wall Panel	3
AGZ	Right Door	1
AGO	Left Door	1
AGF	Entry Gable	1
AGH	Rear Gable 1	1
AGI	Rear Gable 2	1
BYV	Skylight	1
BZD METAL PARTS KIT		
AFG	Truss Brace	2
AFH	Truss Gutter Channel	4
AFM	Wall Support Channel	5
BXX	Rear Wall Support Square Tube	1
AFE	Door Header	1
BYA	Left Angled Door Jamb	1
BYB	Right Angled Door Jamb	1
BXT	Window Wall Support Channel	1
CHH	Door Hinge Tube	2
CHI	Door Square Tube	2

PARTS IDENTIFIER

BOX 1

Parts shown at 4% of actual size

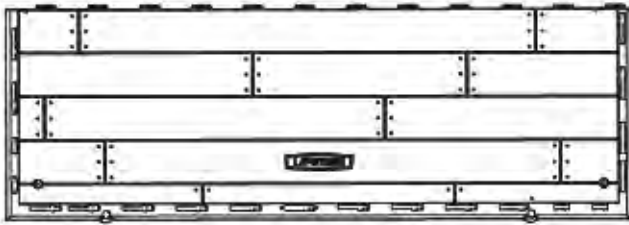

AGR (x2)
Outer Floor Panel

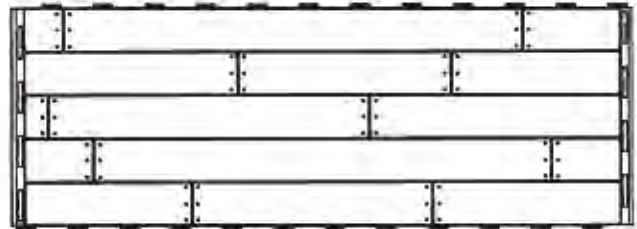

AFX (x1)
Center Floor Panel



AHD (x5)
Wall Panel

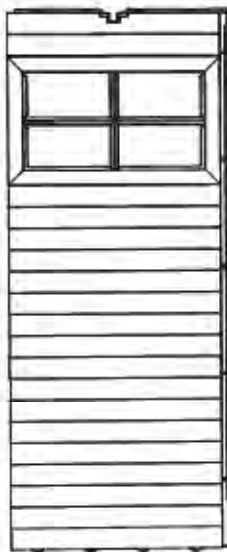

AHH (x1)
Window Wall Panel

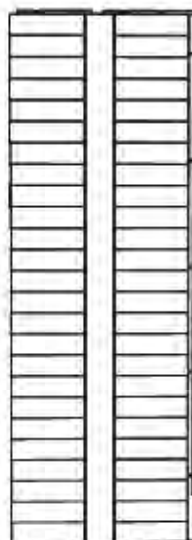

AGL (x1)
Corner Wall Panel

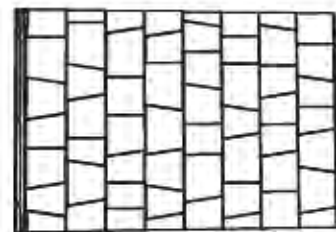

AGQ (x2)
Roof Panel



ANE (x1)
Window

SMALL PARTS BOX [BYU]

Parts shown at 8% of actual size (*Unless noted otherwise)

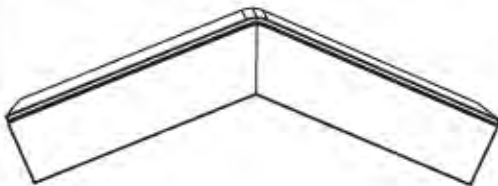

BYW (x2)
Roof End Cap



BYX (x4)
Roof End Cap Filter

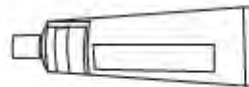

***BZC (x1)**
Tube of Caulking



***AIX (x4)**
Wood Shim

Part shown at 15% of actual size (*Unless noted otherwise)

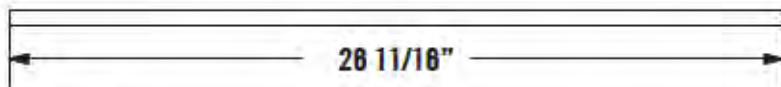

BYY (x6)
Roof Support Tube



***AIW (x1)**
Wood Block

PARTS & HARDWARE IDENTIFIER

BOX 1 (CONT.)

FLOOR ASSEMBLY HARDWARE [BYC]

Hardware shown at actual size

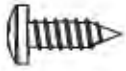

BQC (x4)
#8 x 1/2" Pan-Head Screw



AHO (x2)
Door Hinge Bushing

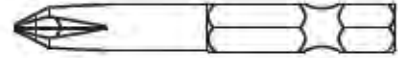

ADC (x1)
#2 Phillips Bit

WALL INSTALLATION HARDWARE [BYE]

Hardware shown at actual size

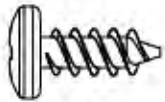

ADZ (x80)
1/4" x 5/8" Pan-Head Screw

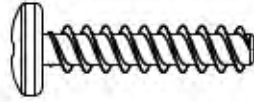

ADV (x6)
1/4" x 1 1/8" Pan-Head Screw

TRUSS ASSEMBLY HARDWARE [BYD] (x2)

Hardware shown at actual size

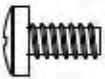

ADY (x12)
#10 x 3/8" Pan-Head Screw



ADK (x12)
#10 Cap Nut



ADJ (x2)
1/4" Cap Nut

Parts shown at 50% of actual size

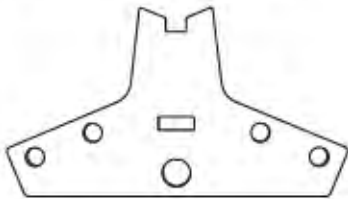

BXU (x1)
Truss Connector A

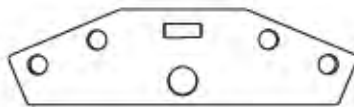

BXV (x1)
Truss Connector B



BXW (x1)
Truss Connector Bracket

Part shown at 25% of actual size

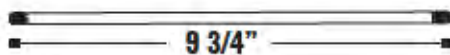

ADH (x1)
1/4" Threaded Rod

! *Note: Throughout the Parts & Hardware List, Part & Hardware Identifiers, and instructions are three-letter IDs. These IDs are below the images of the parts and hardware to help you locate and identify the parts and hardware during assembly. These IDs are not necessarily on the parts themselves.*

PARTS & HARDWARE IDENTIFIER

BOX 1 (CONT.)

GABLE ASSEMBLY HARDWARE [BYF]

Hardware shown at actual size

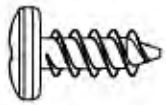

ADZ (x3)
1/4" x 5/8" Pan-Head Screw

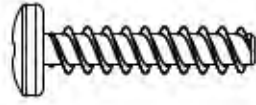

ADV (x6)
1/4" x 1 1/8" Pan-Head Screw

WINDOW ASSEMBLY HARDWARE [BYG]

Hardware shown at actual size (*Unless noted otherwise)

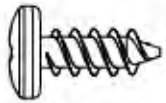

ADZ (x2)
1/4" x 5/8" Pan-Head Screw

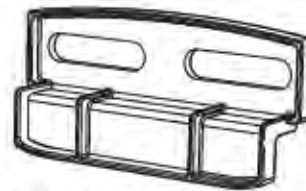

***AIS** (x1)
Window Latch

DOOR & ENTRY GABLE INSTALLATION HARDWARE [BYI]

Hardware shown at actual size

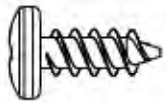

ADZ (x17)
1/4" x 5/8" Pan-Head Screw



AHP (x2)
Cotter Pin

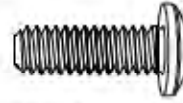

BFY (x5)
1/4" x 3/4" Pan-Head Screw



ADJ (x5)
1/4" Cap Nut



BXZ (x16)
1/4" Nylon Washer

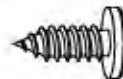

ADX (x2)
#10 x 1/2" Pan-Head Screw

Part shown at 25% of actual size

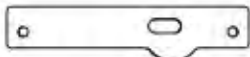

BYM (x1)
Strike Plate

TRUSS, REAR GABLE, & ROOF INSTALLATION HARDWARE [BYL]

Hardware shown at actual size

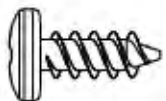

ADZ (x91)
1/4" x 5/8" Pan-Head Screw
(Not all screws will be used)



BYT (x16)
Gable-to-Roof Clip

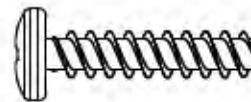

ADV (x24)
1/4" x 1 1/8" Pan-Head Screw

PARTS & HARDWARE IDENTIFIER

BOX 1 (CONT.)

LEFT DOOR ASSEMBLY HARDWARE [BYJ]

Hardware shown at actual size

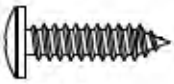

ADW (x5)
#10 x 3/4" Pan-Head Screw

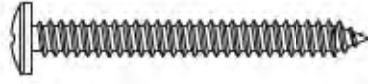

BYZ (x2)
#10 x 1 3/4" Pan-Head Screw

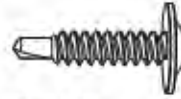

CHK (x1)
#10 x 3/4" Self-Drilling/Self-Tapping Screw



AEE (x7)
#10 Flat Washer



BZB (x4)
#10 x 1/4" Nylon Spacer

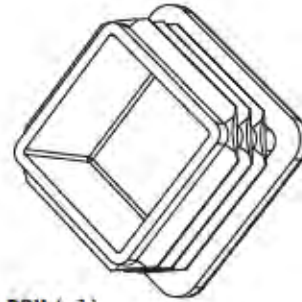

BBH (x1)
1" Square End Cap



ARA (x1)
1/8" Drill Bit

Part shown at 25% of actual size

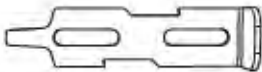

BYQ (x2)
Deadbolt Latch



BYP (x2)
Deadbolt Latch Bracket



BYS (x1)
Outer Door Handle



BYR (x1)
Inner Door Handle

RIGHT DOOR ASSEMBLY HARDWARE [BYK]

Hardware shown at actual size

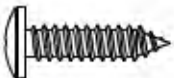

ADW (x1)
#10 x 3/4" Pan-Head Screw

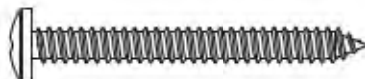

BYZ (x2)
#10 x 1 3/4" Pan-Head Screw



AEE (x1)
#10 Flat Washer



CHK (x1)
#10 x 3/4" Self-Drilling/Self-Tapping Screw

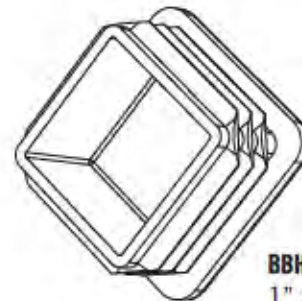

BBH (x1)
1" Square End Cap

Part shown at 50% of actual size

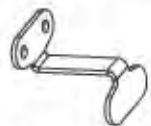

BBI (x1)
Inside Door Handle



BYR (x1)
Inner Handle



BYS (x1)
Outer Handle

PARTS & HARDWARE IDENTIFIER

BOX 1 (CONT.)

LATCH INSTALLATION HARDWARE [CVP]

Hardware shown at actual size

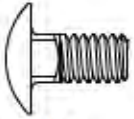

ACA (x3)
1/4" x 1/2" Carriage Bolt



AEB (x3)
1/4" Flat Washer

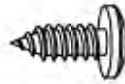

ADX (x9)
#10 x 1/2" Pan-Head Screw



AAB (x3)
1/4" Centerlock Nut



CHK (x2)
#10 x 3/4" Self-Drilling/Self Tapping Screw



AEE (x9)
#10 Flat Washer

Hardware shown at same scale

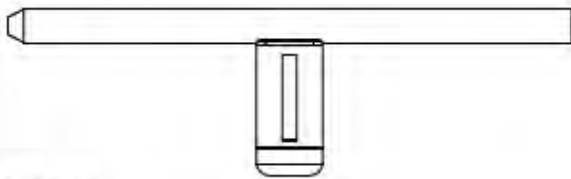

CVW (x1)
Door Latch

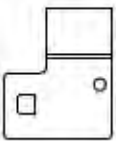

CVT (x1)
Left Door Latch Bracket

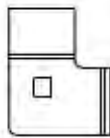

CVU (x1)
Large Right Door Latch Bracket

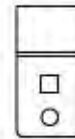

CVV (x1)
Small Right Door Latch Bracket

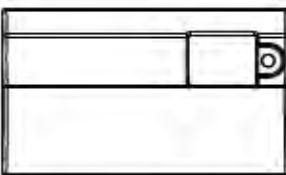

CVS (x1)
Left Door Latch Cover

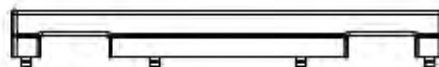

CVR (x1)
Small Right Door Latch Cover



CVQ (x1)
Large Right Door Latch Cover

PARTS IDENTIFIER

BOX 2

Parts shown at 4% of actual size

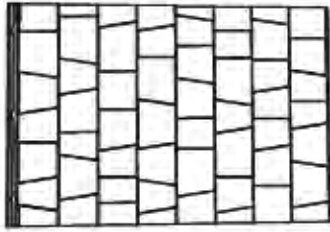

AGQ (x4)
Roof Panel

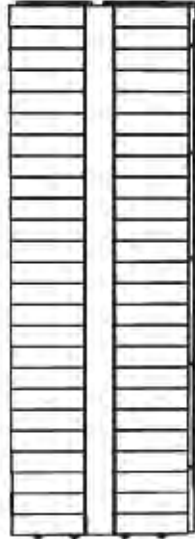

AGL (x3)
Corner Wall Panel

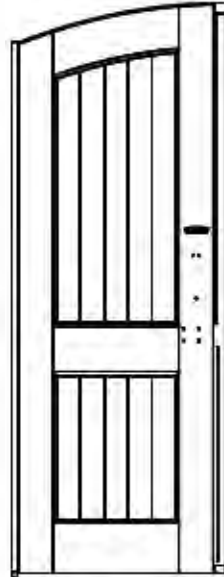

AGO (x1)
Left Door

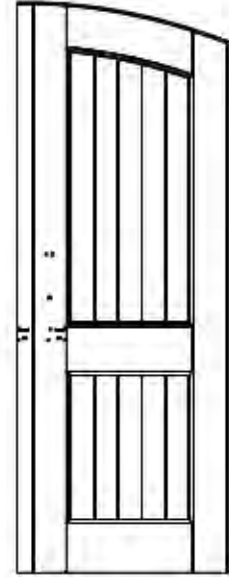

AGZ (x1)
Right Door



AGF (x1)
Entry Gable



AGH (x1)
Rear Gable 1



AGI (x1)
Rear Gable 2



BYV (x1)
Skylight

PARTS IDENTIFIER

BOX 2 (CONT.)

METAL KIT [BZD]

Parts shown at 8% of actual size



AFG (x2)
Truss Brace



AFH (x4)
Truss Gutter Channel



AFM (x5)
Wall Support Channel

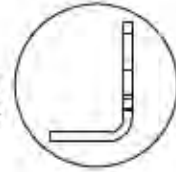

BXX (x1)
Rear Wall Support Square Tube

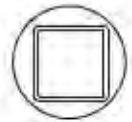

AFE (x1)
Entry Header Bar

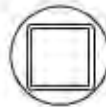

BYA (x1)
Left Angled Door Jamb

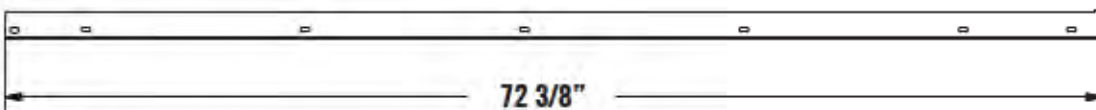

BYB (x1)
Right Angled Door Jamb



BXT (x1)
Window Wall Support Channel

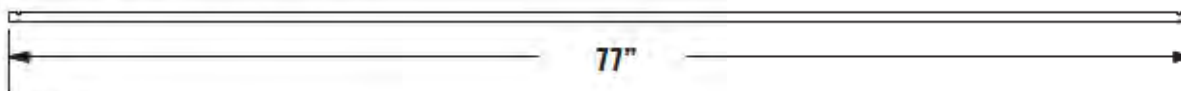
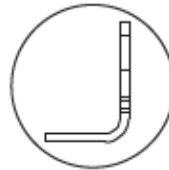

CHH (x2)
Door Hinge Tube

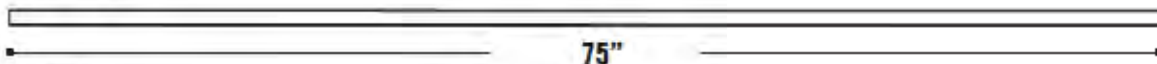

CHI (x2)
Door Square Tube



TOOLS AND HARDWARE REQUIRED FOR THIS PAGE



Concrete (1 cu. yd.)

SEC

1



SEC

1.1

SITE PREPARATION - CONCRETE PLATFORM PREPARATION

The actual dimensions of your shed (at its widest and longest points) are 7' x 7'. Ensure you select a site that will accommodate these measurements. The base of the shed is slightly smaller than this, so you will need to create a level surface that is at least 81 1/2" Wide x 83 3/8" Long. We recommend using a level cement or patio style surface. This will provide the best long-term performance for your shed.

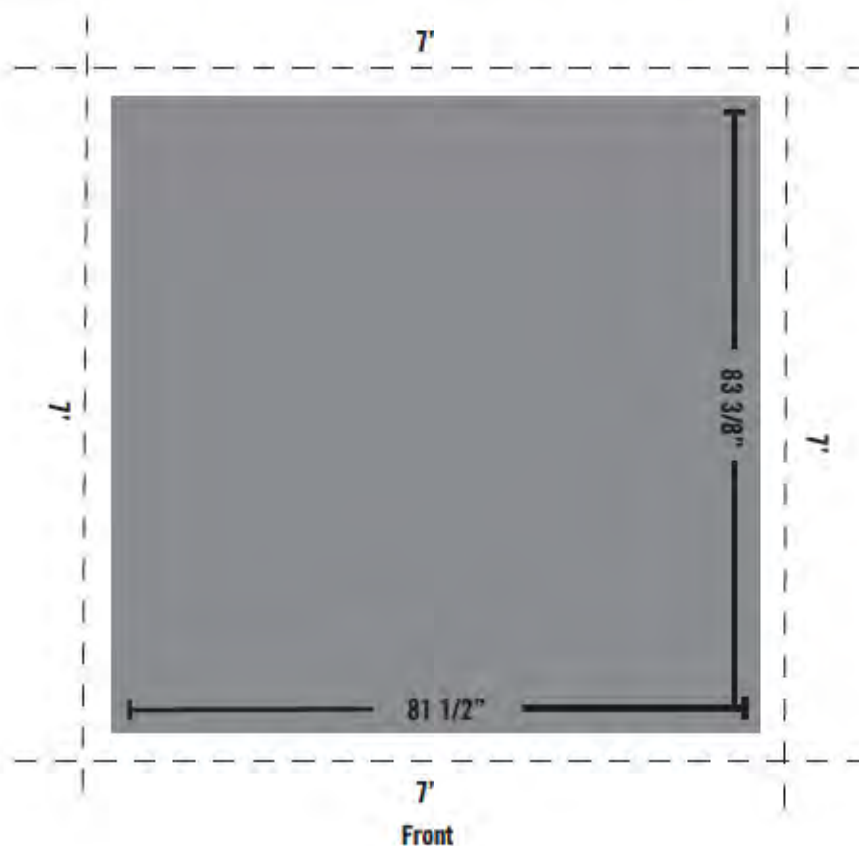

Note: Surface must be leveled before installation. If the surface is not properly leveled, the shed will not assemble or function correctly. Proper surface leveling will save you time in the long run, so please do not ignore this step.



Note: Any platform or similar structure should be built above ground in order to avoid water pooling inside the shed.



TOOLS AND HARDWARE REQUIRED FOR THIS PAGE



2" x 4" x 81 1/2" Treated Board (x2)

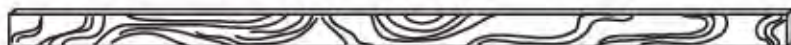

2" x 4" x 80 3/8" Treated Board (x7)



16d 3" Common Nail (x28)

SEC 1



SEC

1.2

ALTERNATIVE SITE PREPARATION: OPTION 1 - WOOD PLATFORM ASSEMBLY

Ensure you use lumber that is treated and approved for outdoor use. Build outside frame to 81 1/2" Wide x 83 3/8" Long.



Note: Whenever possible you should use the surfaces described on Page 7. When this is not possible, we recommend you use a wood platform or a filled wood frame.



Note: All lumber must be rated for outdoor use.

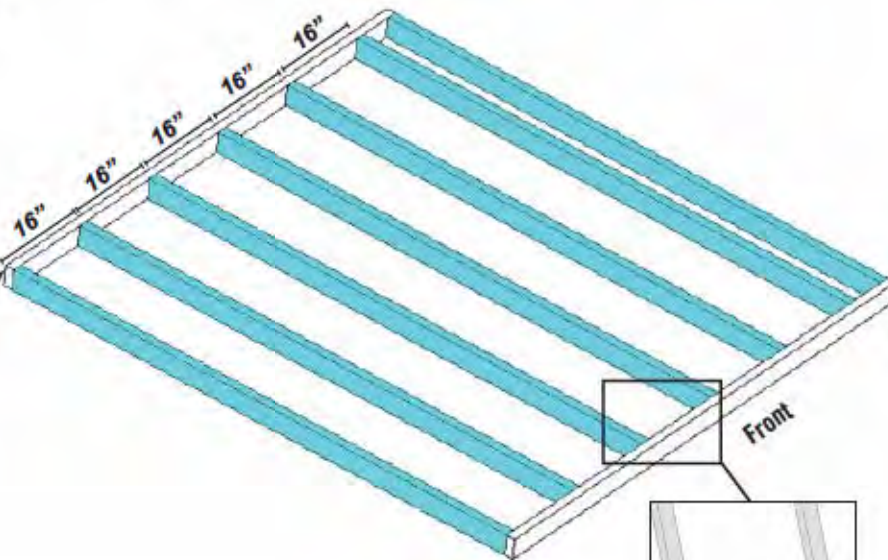
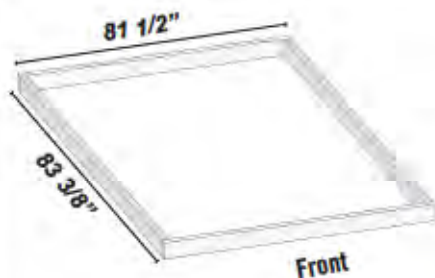

To ensure studs are in the correct location to nail plywood in the next step, start measuring at the corner 16", and then measure from center to center.

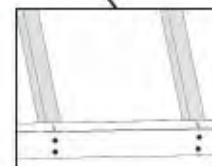

Place the 2" x 4" x 80 3/8" boards on the inside of the frame. Nail each board in place with the 16d nails.



Note: Surface must be leveled before installation. If the surface is not properly leveled, the Outdoor Shed will not assemble or function correctly. Proper surface leveling will save you time in the long run, so please do not ignore this step.



TOOLS AND HARDWARE REQUIRED FOR THIS PAGE



48" x 83 3/8" x 3/4" Treated Plywood (x1)



33 1/2" x 83 3/8" x 3/4" Treated Plywood (x1)

8d 1 1/2" Common Nail (x36)

SEC 1



SEC

1.3

ALTERNATIVE SITE PREPARATION: OPTION 1 - WOOD PLATFORM ASSEMBLY (CONT)

Square up the frame by measuring from corner to corner. Measurement A should equal Measurement B.



Note: All lumber must be rated for outdoor use.

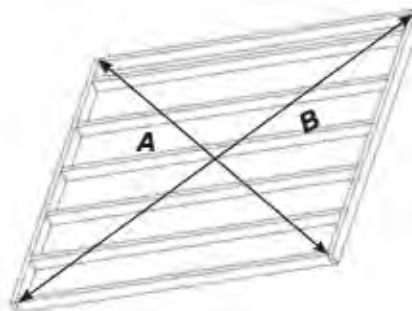

SEC

1.4

Cut Plywood into sizes called for above. Arrange the Plywood according to the diagram and nail into place with 8d x 1 1/2" nails. Place platform in the desired location. If platform does not rest level on the ground, build up low points with loose dirt until platform is stable. Drill three evenly spaced 1/2" drain holes in plywood between each 2" x 4".

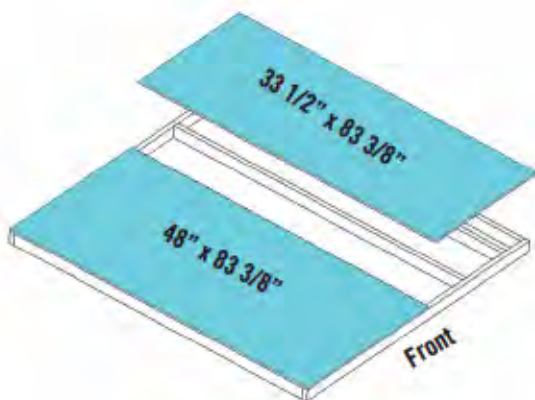



TOOLS AND HARDWARE REQUIRED FOR THIS PAGE

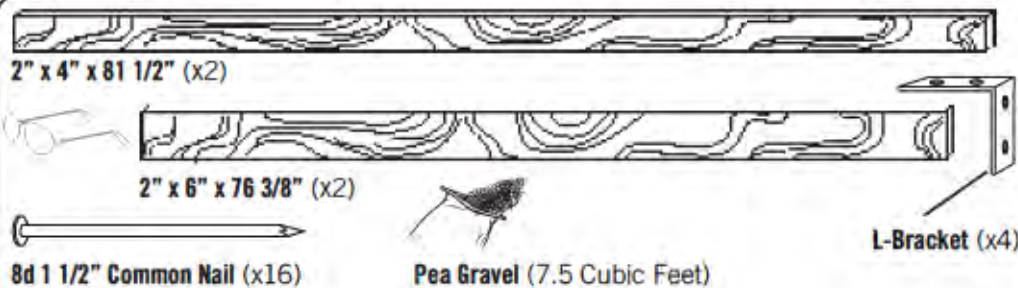

SEC 1

SEC

1.5

ALTERNATIVE SITE PREPARATION: OPTION 2 - FILLED WOOD FRAME ASSEMBLY

Cut outside frame to 81 1/2" Wide x 83 3/8" Long outside dimensions. **Lay boards flat so widest part faces up.** Ensure frame is level. Square up the frame by measuring from corner to corner. Measurement A should equal Measurement B. Nail an L-Bracket on each corner of the frame with 8d x 1 1/2" Common Nails. Place platform in the desired location. If platform does not rest level on the ground, build up low points with loose dirt or "Pea Gravel", until platform is stable.



Note: Whenever possible you should use the surfaces described on Page 7.



Note: All lumber must be rated for outdoor use.

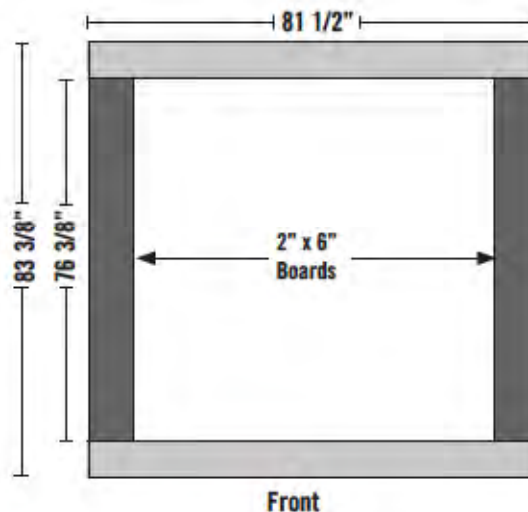
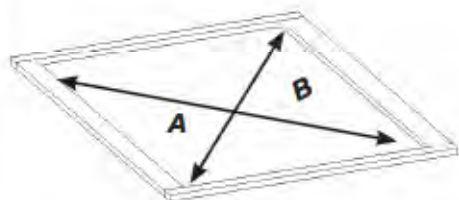

SEC

1.6

Once all boards are level and do not wobble, pack "Pea Gravel" around the outside of the frame, and slope away from frame.

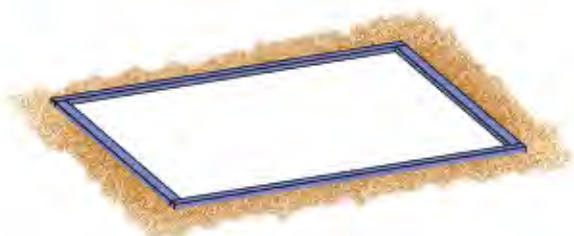

SEC

1.7

Now fill the inside of the frame with "Pea Gravel". Use a leveling board to scrape off extra fill material and to level the surface.

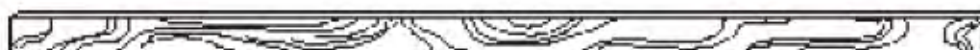
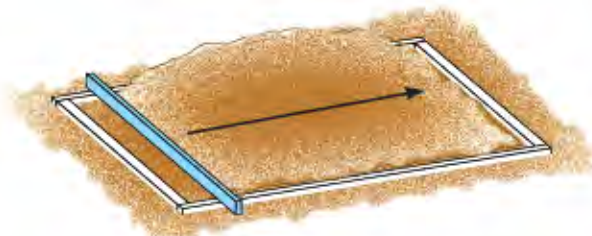

2" x 4" x 7' Leveling Board (x1)

SEC 2 FLOOR ASSEMBLY

HARDWARE REQUIRED

HARDWARE BAG REQUIRED: BYC

Hardware shown at actual size

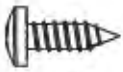

BQC (x4)
#8 x 1/2" Pan-Head Screw



AHO (x2)
Door Hinge Bushing

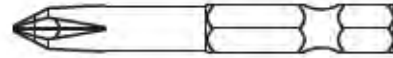

ADC (x1)
#2 Phillips Bit

PLASTIC PARTS REQUIRED

Parts shown at 4% of actual size

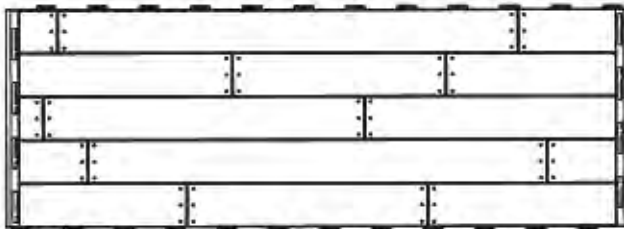

AFX (x1)
Center Floor Panel

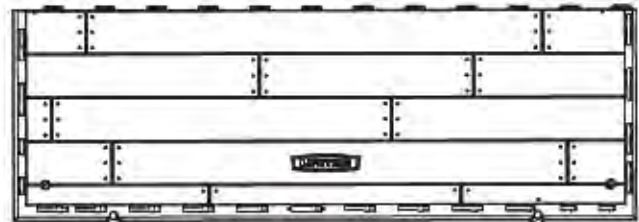

AGR (x2)
Outer Floor Panel

TOOLS REQUIRED

HARDWARE BAG REQUIRED: BYC



Phillips Screwdriver

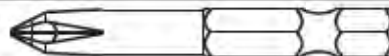

ADC (x1)
#2 Phillips Bit (Included)



Safety Glasses



TOOLS AND HARDWARE REQUIRED FOR THIS PAGE

SEC 2



NO HARDWARE REQUIRED FOR THIS PAGE

SEC

2.1

FLOOR ASSEMBLY

Lay an **Outer Floor Panel (AGR)** flat on the ground. Hold a **Center Floor Panel (AFX)** at an angle as shown and fit the tabs into the slots. Lay the Center Floor Panel flat.

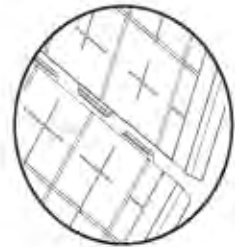
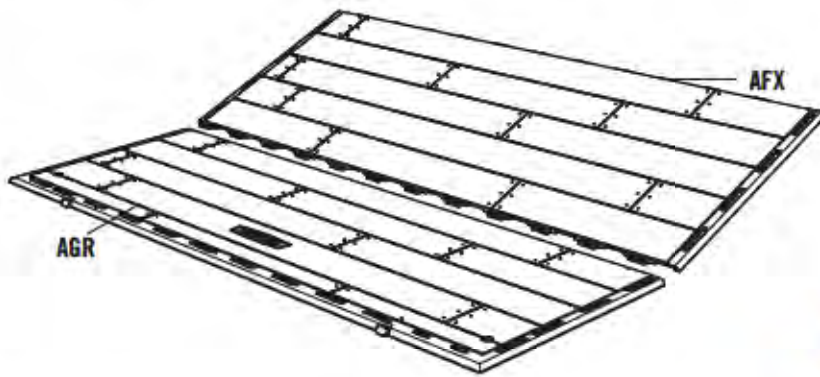

CAUTION

Sharp objects may damage your floor. If resting sharp, heavy objects on your shed floor, place a block of wood between the sharp object and floor.

SEC

2.2

Hold the second **Outer Floor Panel (AGR)** at an angle as shown and fit its tabs between the tabs on the Center Floor Panel. Lay the Outer Floor Panel flat.

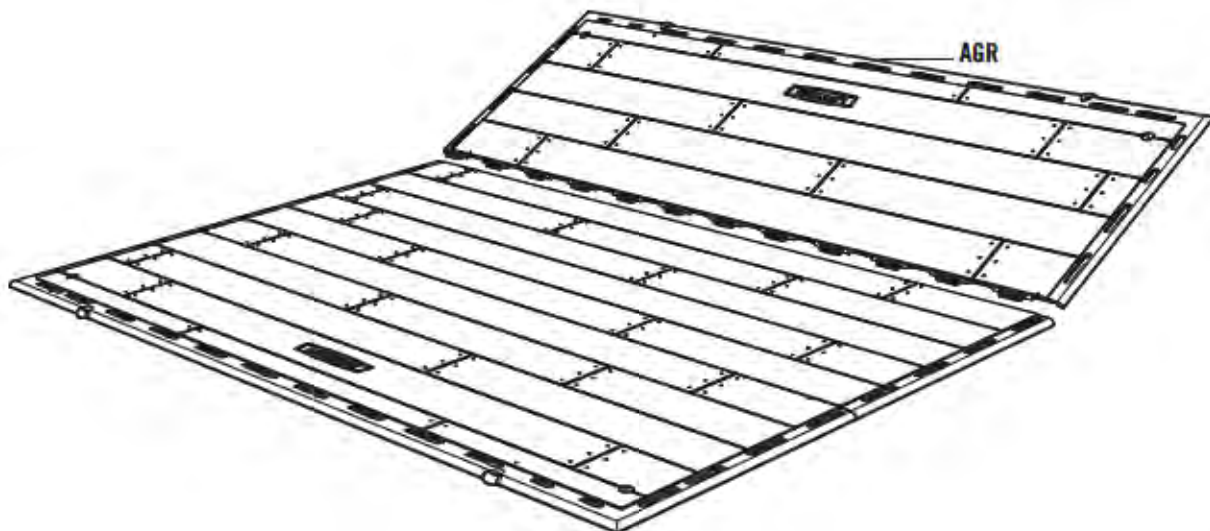



TOOLS AND HARDWARE REQUIRED FOR THIS PAGE

SEC 2



AHO (x2)

SEC

2.3

Decide which end will be the front of your shed. Lift the Floor Panels up enough to slide the **Door Hinge Bushings (AHO)** under and up through the holes in the front Outer Floor Panel as shown.

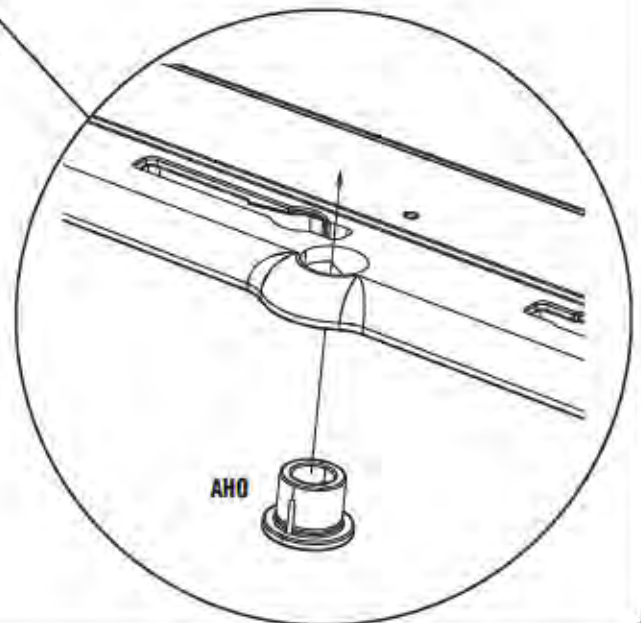
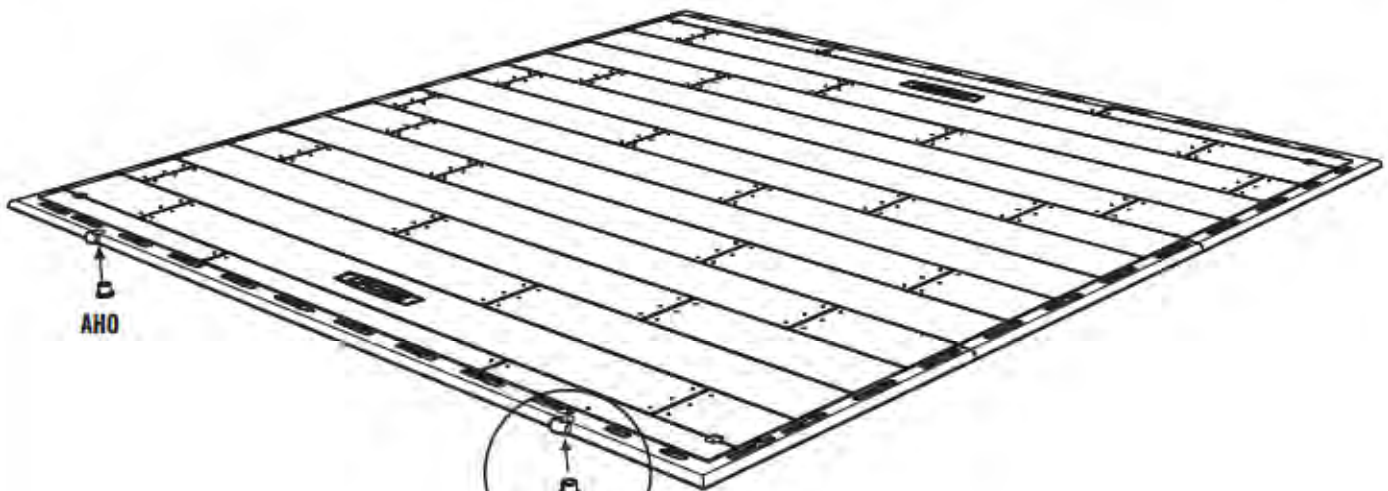



TOOLS AND HARDWARE REQUIRED FOR THIS PAGE

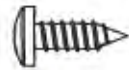
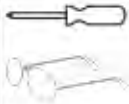

BQC (x4)

SEC 2



SEC

2.4

Face the seam of the two adjacent Floor Panels. Insert one (1) #8 x 1/2" Pan-Head Screw (BQC) into the divot near the seam of the Outer Floor Panel and down into the tab of the adjacent Center Floor Panel at the locations indicated. **Do not overtighten.**

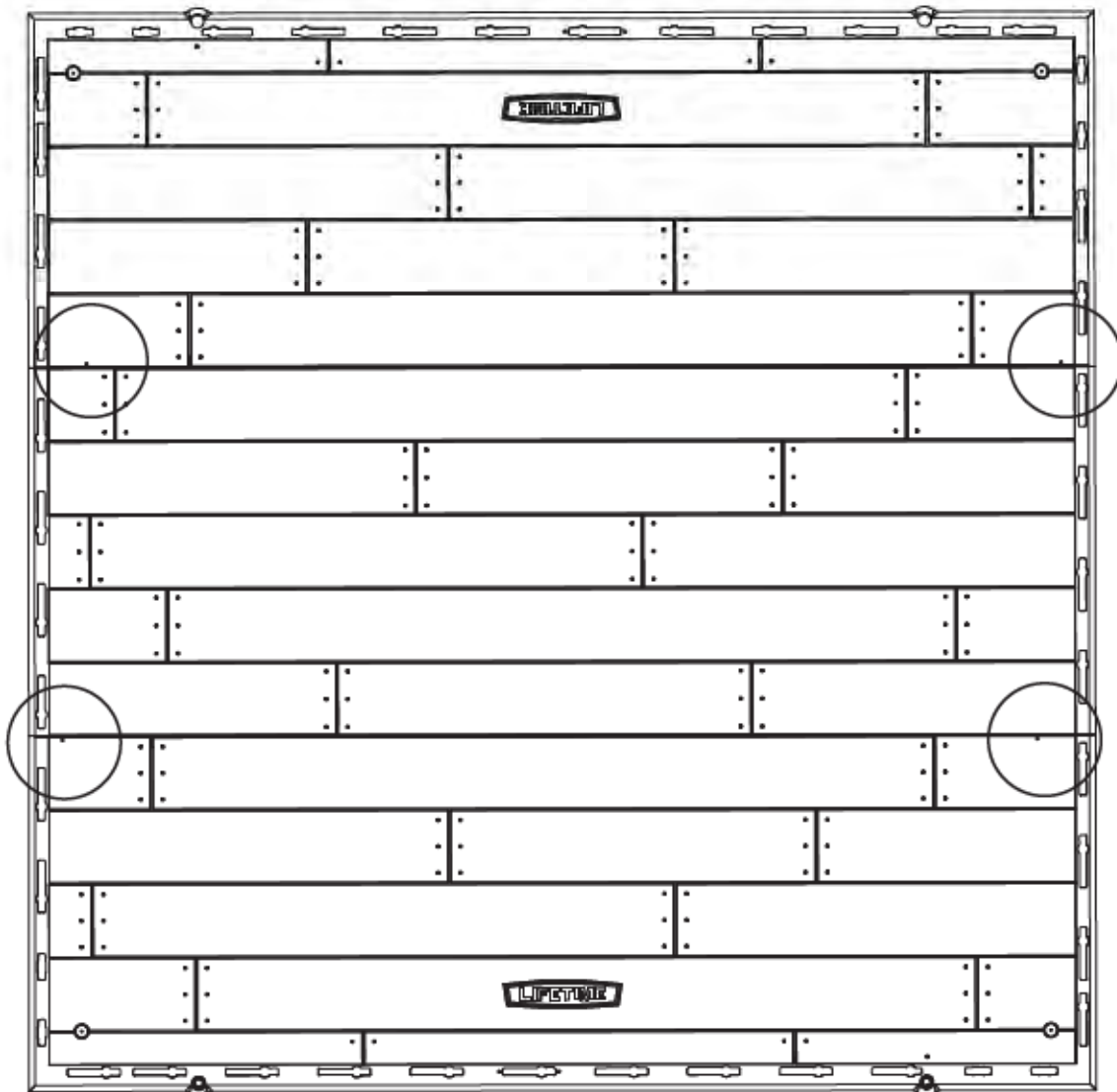



TOOLS AND HARDWARE REQUIRED FOR THIS PAGE



IF YOU PLAN ON ANCHORING YOUR SHED, CHECK WITH YOUR LOCAL HARDWARE STORE FOR SUITABLE HARDWARE.

SEC 2



SEC

2.5

ANCHORING THE SHED

If you plan on anchoring your shed, you can anchor it to your platform through the four indentations near the corners of the floor. The anchoring hardware used depends on the platform. If you have a concrete platform, we recommend using four (4) 3/8" Anchor Bolts and four (4) 3/8" x 1" Fender Washers. If you have a wood framed platform, we recommend using four (4) 3/8" Lag Bolts and four (4) 3/8" x 1" Fender Washers. **Do not exceed a 3/8" diameter bolt. Refer to your local hardware store for this hardware.**

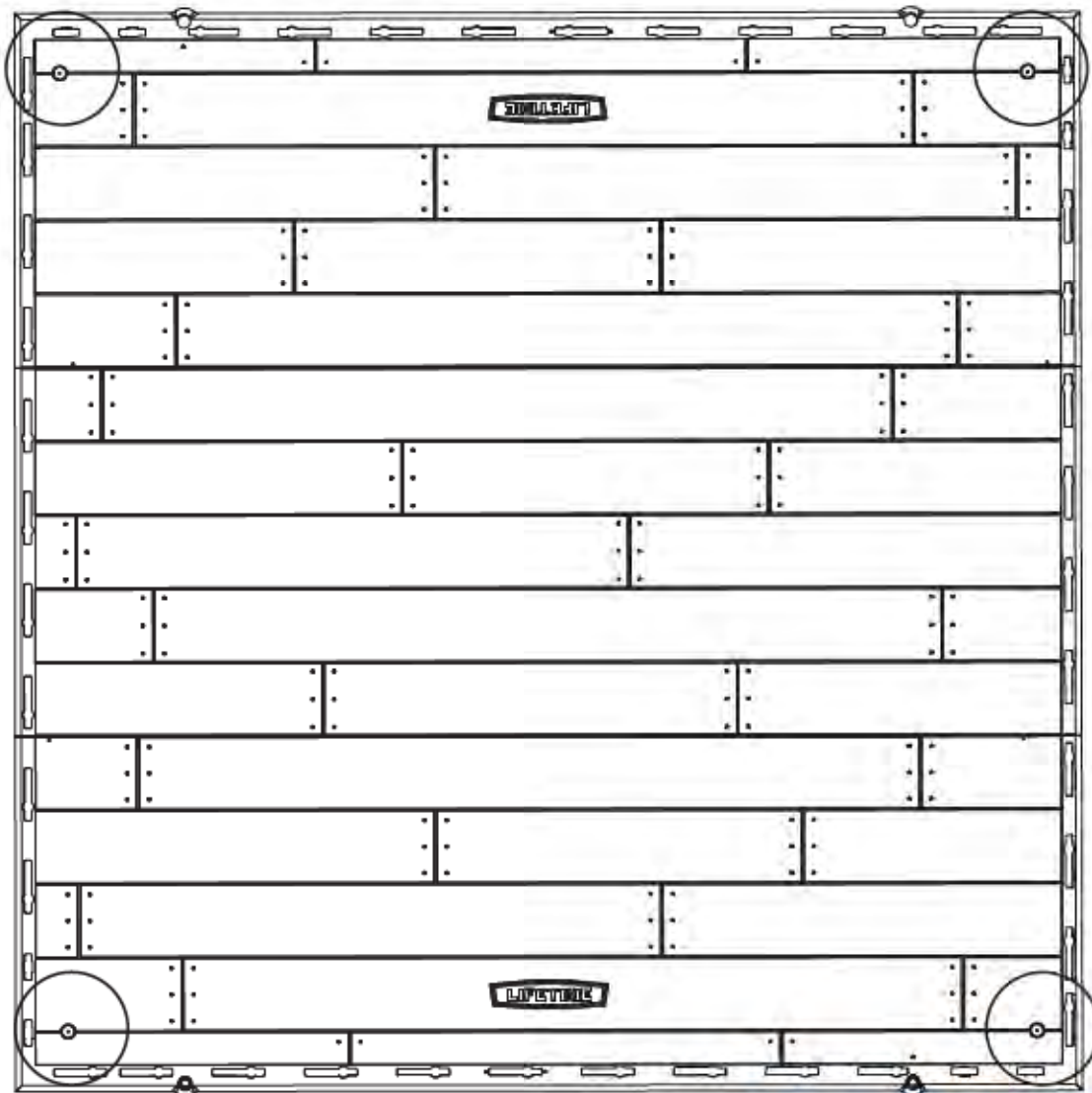

WARNING

Failure to anchor the shed may result in property damage and/or personal injury.

SEC 3 TRUSS ASSEMBLY

HARDWARE REQUIRED

Hardware shown at actual size

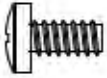

ADY (x24)
#10 x 3/8" Screw



ADK (x24)
#10 Cap Nut



ADJ (x4)
1/4" Cap Nut

Part shown at 50% of actual size

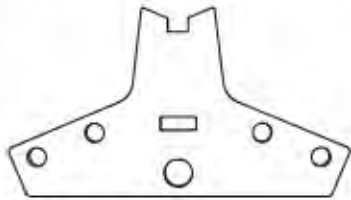

BXU (x2)
Truss Connector A



BXV (x2)
Truss Connector B



BXW (x2)
Truss Connector Bracket

Part shown at 25% of actual size

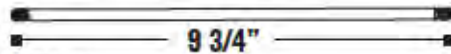

ADH (x2)
1/4" Threaded Rod

METAL PARTS REQUIRED

Parts shown at 8% of actual size

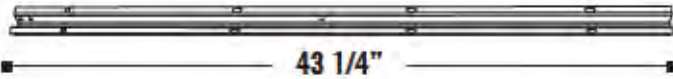

AFH (x4)
Truss Gutter Channel



AFG (x2)
Truss Brace

TOOLS REQUIRED



Phillips Screwdriver



7/16" Wrench



3/8" Wrench



Safety Glasses



TOOLS AND HARDWARE REQUIRED FOR THIS PAGE

SEC 3

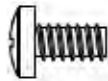

ADY (x8)



ADK (x8)



SEC

TRUSS ASSEMBLY

3.1

Insert four (4) #10 x 3/8" Pan-Head Screws (ADY) through a Truss Connector A (BXU) as shown.

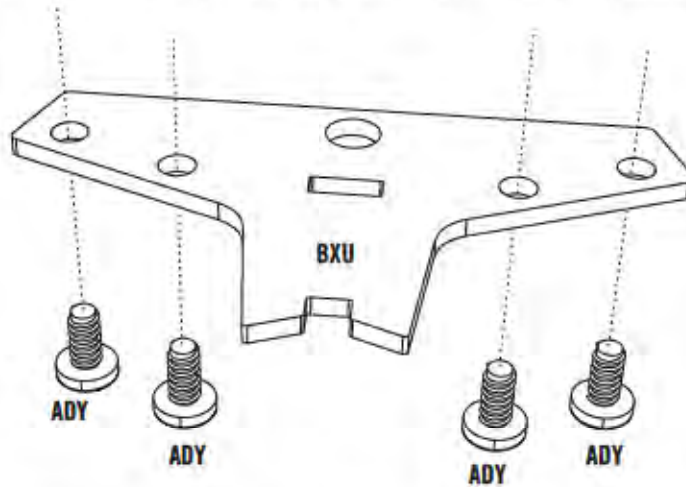

SEC

3.2

Place two (2) Truss Gutter Channels (AFH) over the Truss Connector as shown and insert the four Screws through the four holes in the Truss Gutter Channels. Lightly secure the Screws with four (4) #10 Cap Nuts (ADK). **Hand tighten only in this step.**

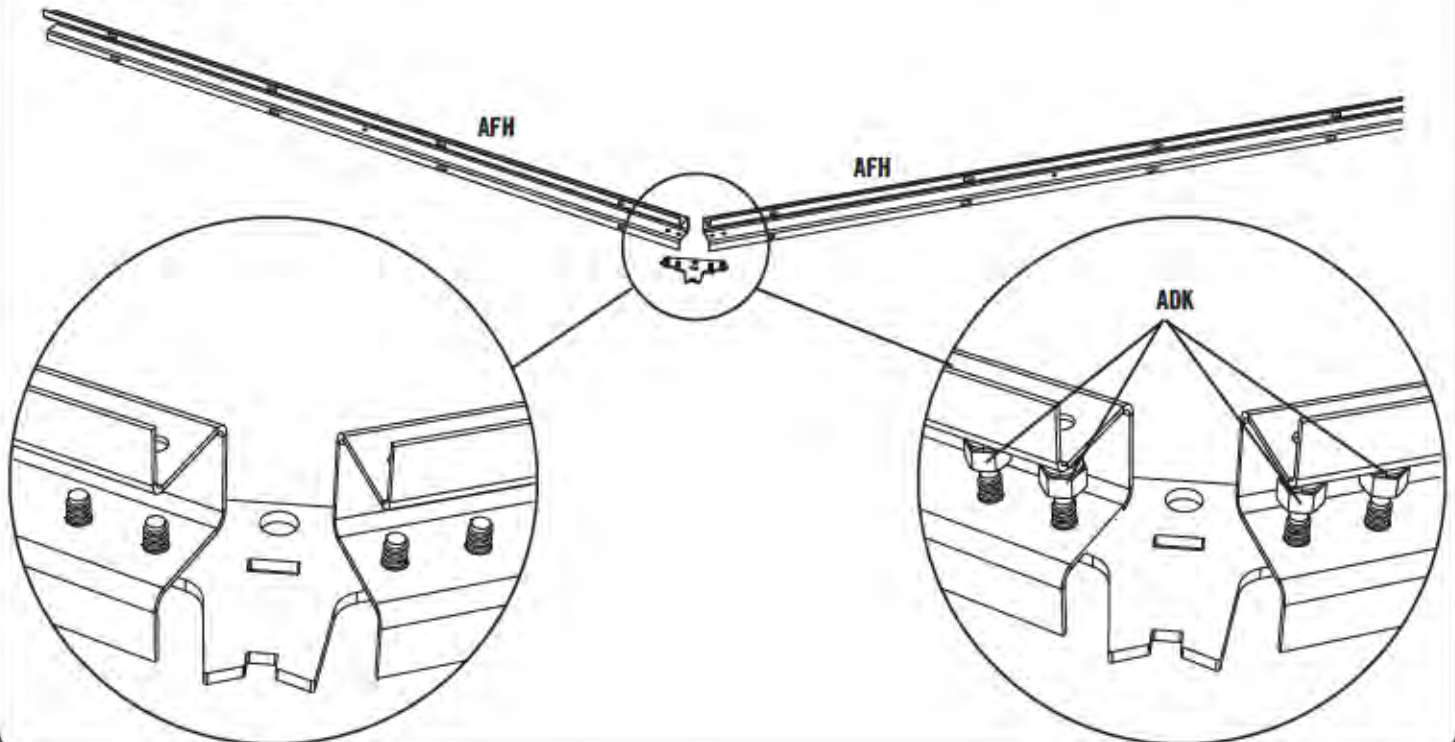



TOOLS AND HARDWARE REQUIRED FOR THIS PAGE

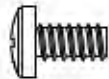

ADY (x8)



ADK (x8)

SEC 3



SEC

3.3

Insert a **Truss Connector Bracket (BXW)** into the slot in **Truss Connector A** as shown.

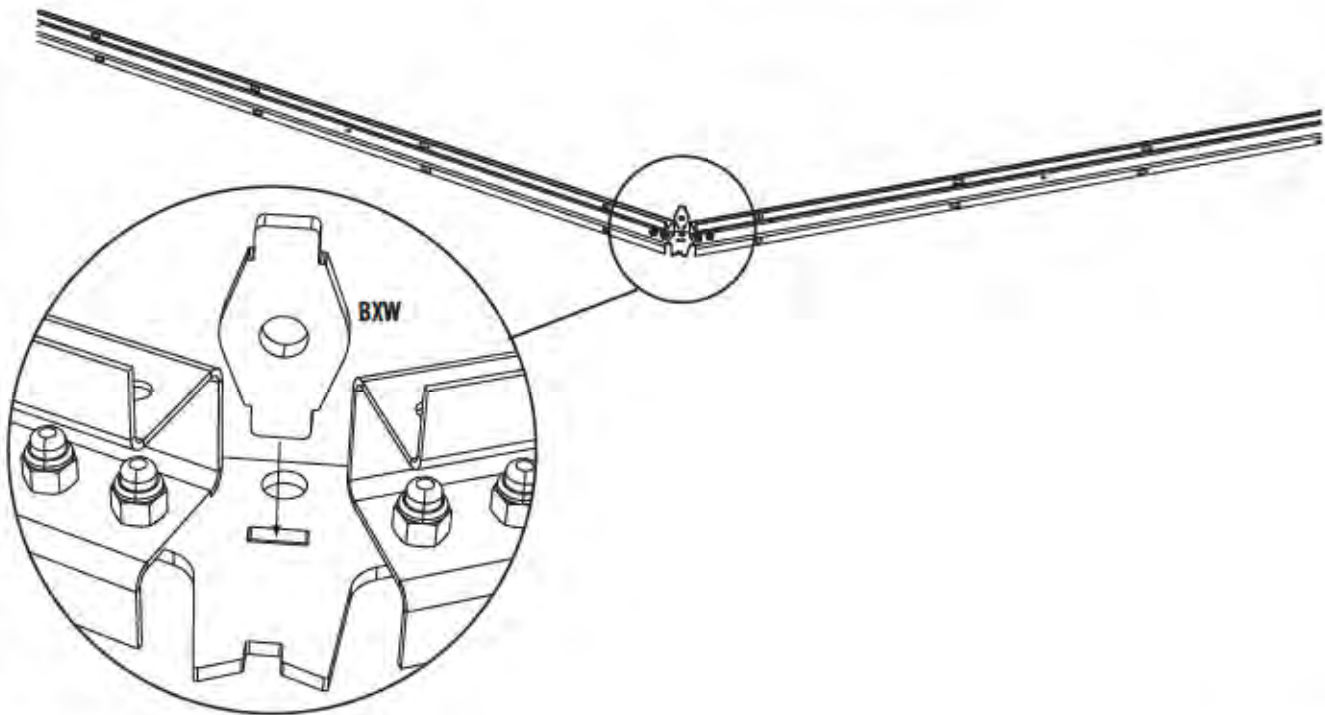

SEC

3.4

Place **Truss Connector B (BXV)** over the **Truss Connector Bracket** and the **Truss Gutter Channels** as shown. Insert four (4) **#10 x 3/8" Pan-Head Screws (ADY)** through a **Truss Connector B** as shown and lightly secure the Screws with four (4) **#10 Cap Nuts (ADK)**. **Hand tighten only in this step.**

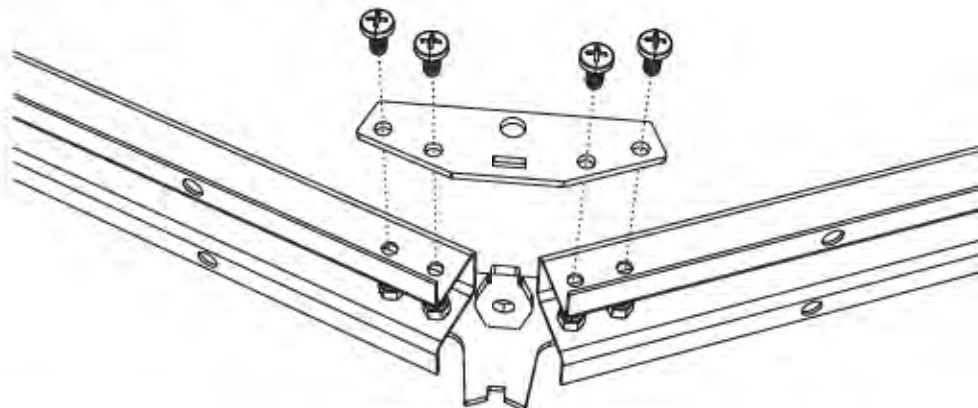



TOOLS AND HARDWARE REQUIRED FOR THIS PAGE



7/16"



3/8"

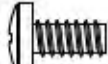

ADY (x8)



ADK (x8)



ADJ (x4)

SEC 3



SEC

3.5

With the Truss Assembly on its side, align the holes in a **Truss Brace (AFG)** with those in the Truss Gutter Channels as shown. Secure with four (4) **#10 x 3/8" Pan-Head Screws (ADY)** and four (4) **#10 Cap Nuts (ADK)**. **Hand tighten only in this step.**

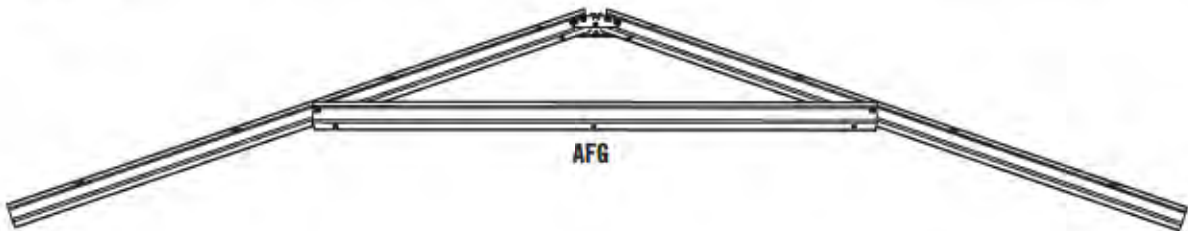

SEC

3.6

With the Truss Assembly on its side, slide a **1/4" Threaded Rod (ADH)** through the Truss Brace and Truss Connector Bracket as shown. Secure the top and bottom of the 1/4" Threaded Rod with a **1/4" Cap Nut (ADJ)**. **Tighten securely.** Finally tighten all hardware. Set aside. **Repeat this section for the second Truss Assembly.**

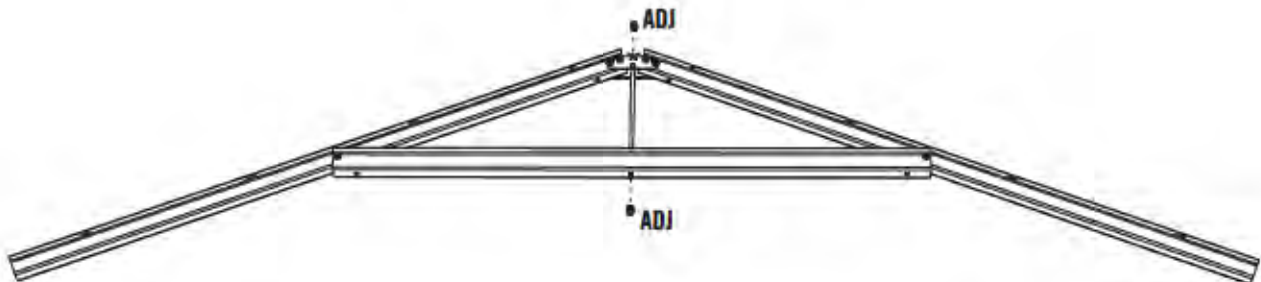
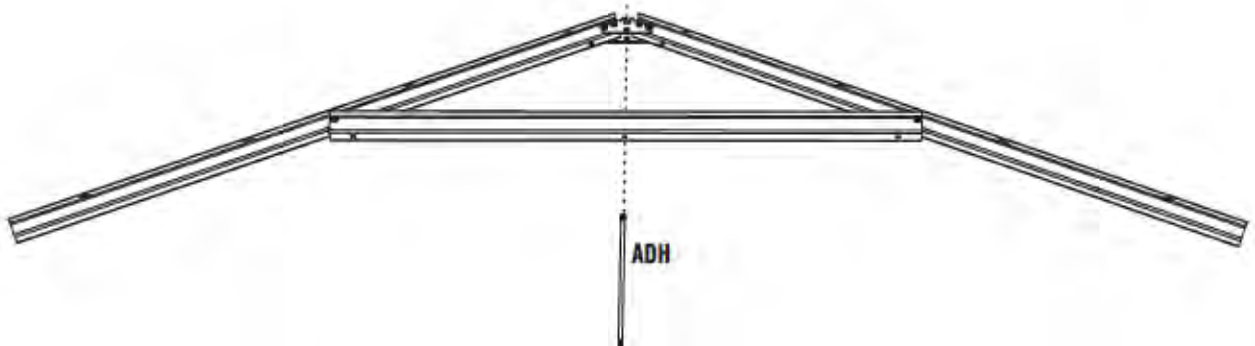

SEC 4 WALL INSTALLATION

HARDWARE REQUIRED

HARDWARE BAG REQUIRED: BYE

Hardware shown at actual size

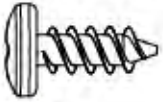

ADZ (x80)
1/4" x 5/8" Pan-Head Screw

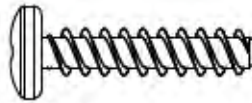

ADV (x6)
1/4" x 1 1/8" Pan-Head Screw

METAL PARTS REQUIRED

METAL PARTS KIT REQUIRED: BZD

Parts shown at 8% of actual size

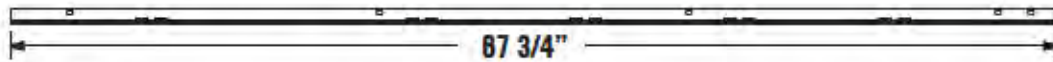

AFM (x5)
Wall Panel Support Channel



BXT (x1)
Window Wall Panel Support Channel



BXX (x1)
Rear Wall Support Square Tube

PLASTIC PARTS REQUIRED

Parts shown at 4% of actual size

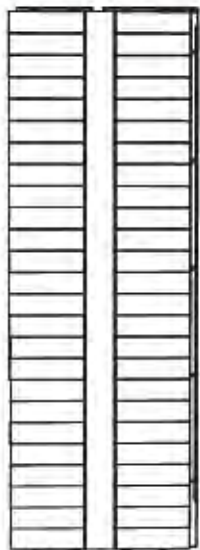

AGL (x4)
Corner Wall Panel

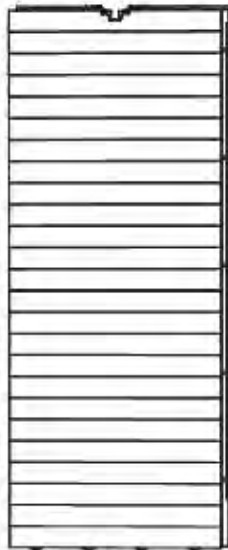

AHD (x5)
Wall Panel



AHH (x1)
Window Wall Panel

TOOLS REQUIRED

SMALL PARTS BOX REQUIRED: BYU

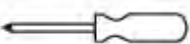

Phillips Screwdriver



Safety Glasses



*AIW Wood Block (x1) (Provided)



TOOLS AND HARDWARE REQUIRED FOR THIS PAGE



*AIW (x1)
Wood Block

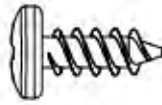

ADZ (x10)

SEC 4



SEC

4.1

WALL PANEL INSTALLATION

Insert the tabs at the bottom of a **Corner Wall Panel (AGL)** into the holes in the slots on the front of the right, front corner of the Floor as shown. Slide the Panel to the right. Fold the Corner Wall Panel and snap the tabs at the bottom of the Panel down into the two slots along the right border of the Floor. If necessary, place the **Wood Block (AIW)** underneath the Floor, directly below the tab to be inserted, when snapping the tabs in place.

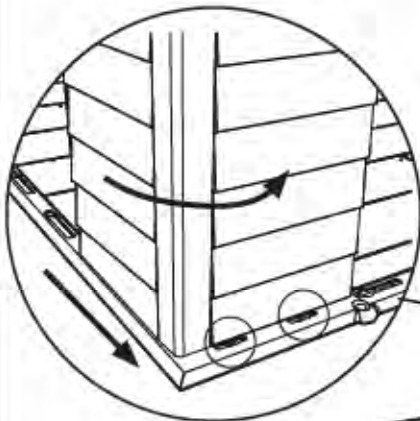

AGL

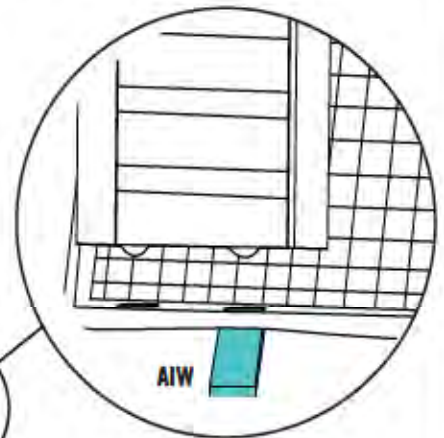

AIW

SEC

4.2

One at a time, insert two **Wall Panels (AHD)** into the holes in the slots along the right side of the shed, and slide the Panels toward the Corner Wall Panel. **The Window Wall Panel (AHH) may be inserted on either side of the shed.** Ensure the tops of the Wall Panels are even with the Corner Wall Panel and the holes align. Insert **1/4" x 5/8" Pan-Head Screws (ADZ)** through the holes to fasten the Panels together as shown.

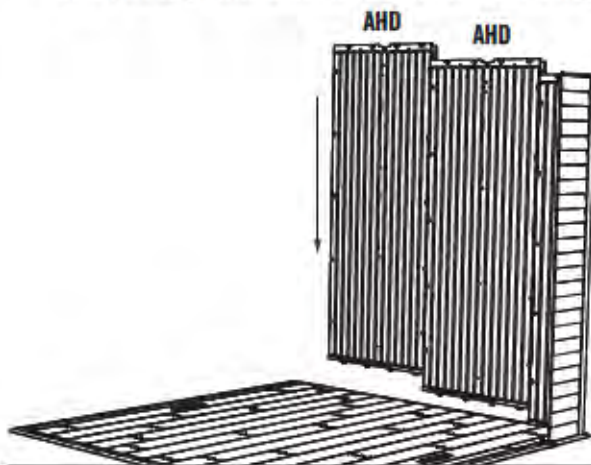

AHD

AHD

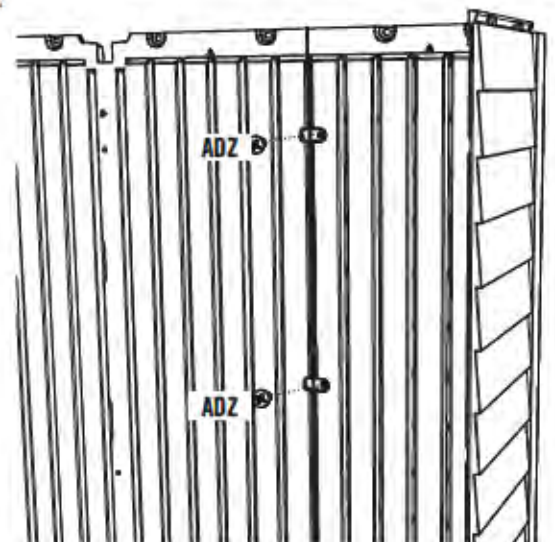

ADZ

ADZ



Note: A second person should apply pressure on the opposite side of the Wall Panels for easier insertion of the Screw. Do not overtighten Screw.



TOOLS AND HARDWARE REQUIRED FOR THIS PAGE



*AIW (x1)
Wood Block



ADZ (x15)

SEC 4



SEC

4.3

Slide and snap another **Corner Wall Panel (AGL)** into place in the same manner as you did earlier. Fasten with the required hardware. If necessary, place the **Wood Block (AIW)** underneath the Floor, directly below the tab to be inserted, when snapping the tabs in place.

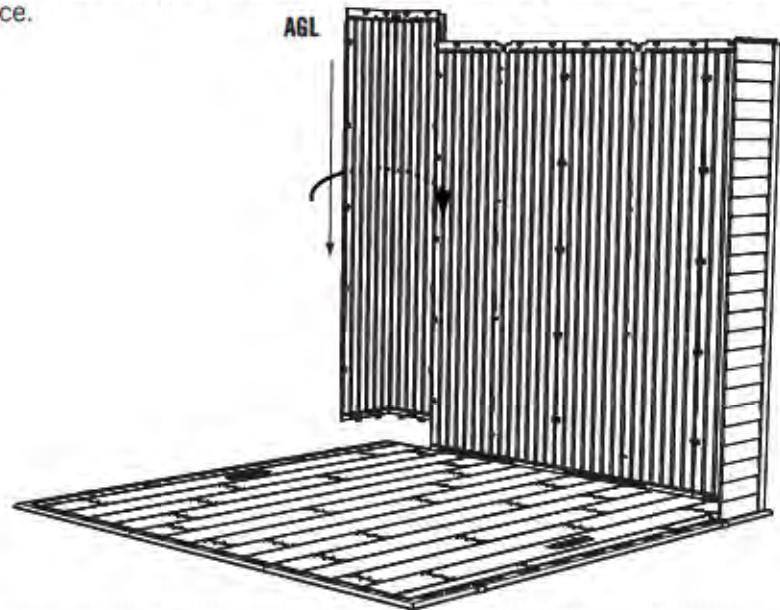

SEC

4.4

One at a time, insert two **Wall Panels (AHD)** along the rear border of the Floor. Ensure the tops are level and the holes line up before fastening the Panels together with the required hardware.

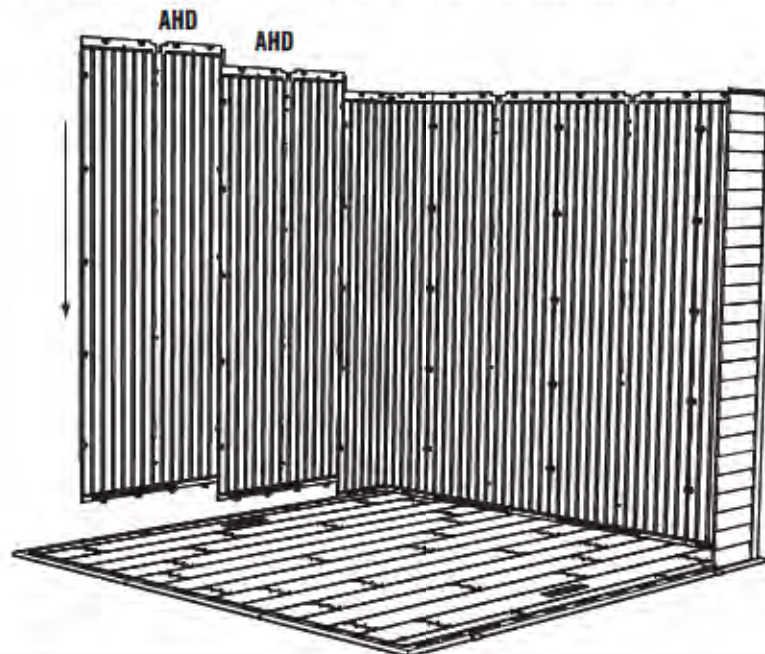



TOOLS AND HARDWARE REQUIRED FOR THIS PAGE

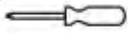

*AIW (x1)
Wood Block



SEC 4



SEC

4.5

Fold a **Corner Wall Panel (AGL)**. Slide and snap it into place in the same manner as you did earlier. Fasten with the required hardware. If necessary, place the **Wood Block (AIW)** underneath the Floor, directly below the tab to be inserted, when snapping the tabs in place.

AGL

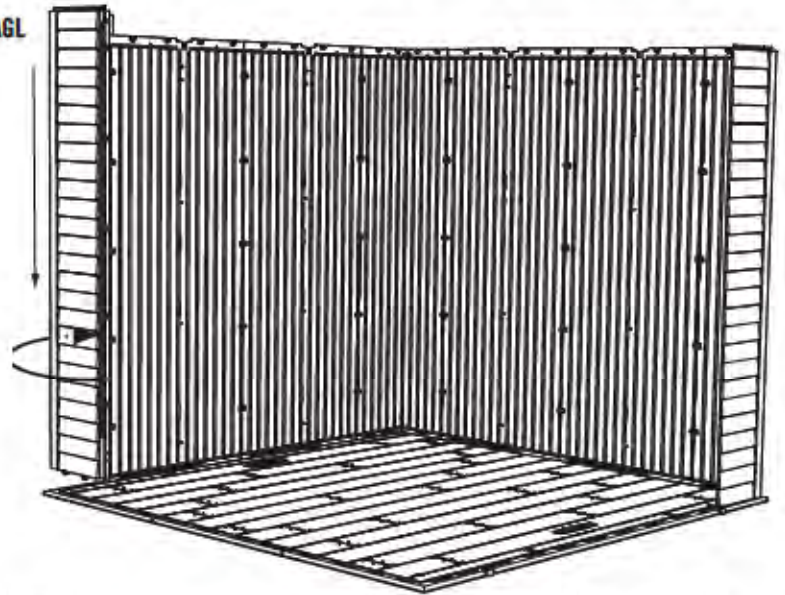

SEC

4.6

Snap a **Window Wall Panel (AHH)** and a **Wall Panel (AHD)** into place along the right side of the shed. **The Window Wall Panel may be inserted on either side of the shed.** Ensure the top of the Wall Panels are even with the Corner Wall Panel and the holes align. Insert **1/4" x 5/8" Pan-Head Screws (ADZ)** through the holes of the Wall Panels to fasten them together.

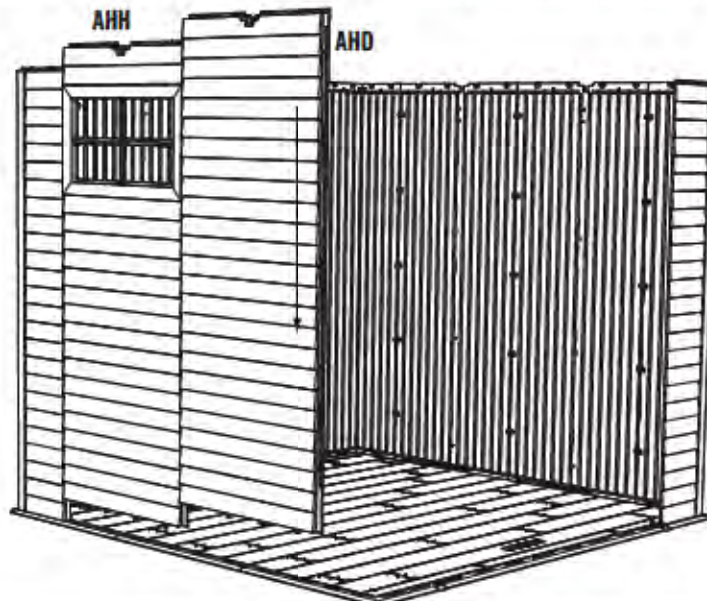



TOOLS AND HARDWARE REQUIRED FOR THIS PAGE

SEC 4

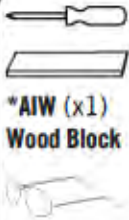

SEC

4.7

Fold a **Corner Wall Panel (AGL)**. Slide and snap it into place in the same manner as you did earlier. Fasten with the required hardware. If necessary, place the **Wood Block (AIW)** underneath the Floor, directly below the tab to be inserted, when snapping the tabs in place.

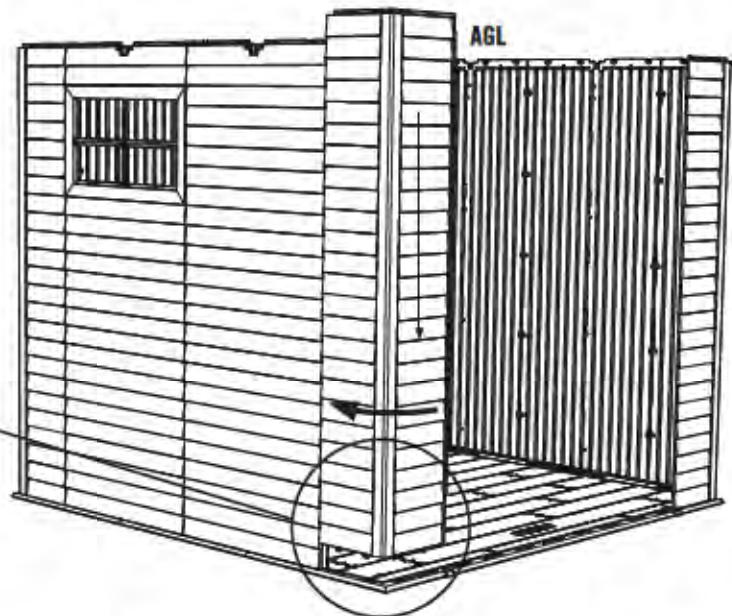
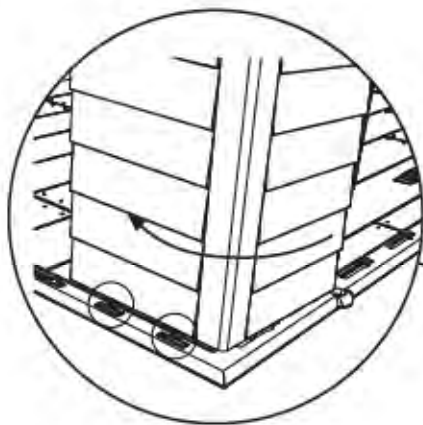

SEC

4.8

Insert a **Wall Support Channel (AFM)** into the groove directly below the truss notch of each Wall Panel, including the rear Wall Panels, as shown. Secure using the required hardware. Insert a **Window Wall Support Channel (BXT)** directly below the Window in the Window Wall Panel using the required hardware.

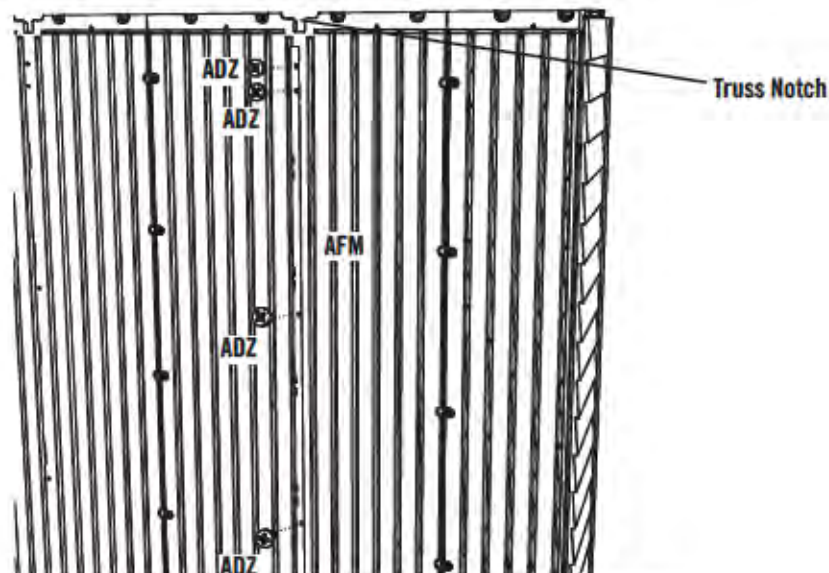



TOOLS AND HARDWARE REQUIRED FOR THIS PAGE

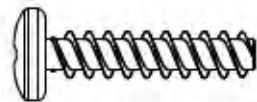
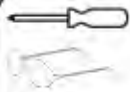

ADV (x6)

SEC 4



SEC

4.9

Align the holes in the **Rear Wall Support Square Tube (BXX)** with the screw bosses along the top of the rear Wall Panels as shown. Secure the Rear Wall Support Tube to the Wall Panels using six (6) 1/4" x 1 1/8" Pan-Head Screws (ADV). Tighten securely, but do not overtighten.

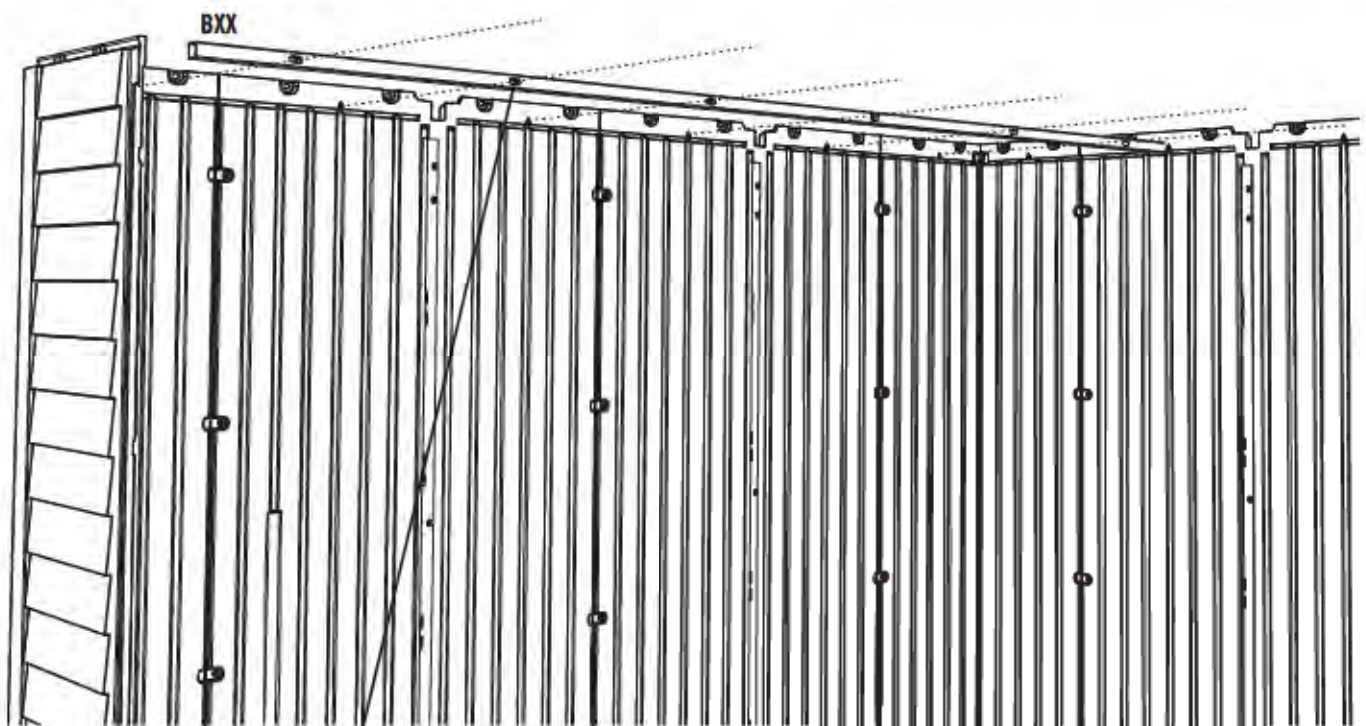

The indented, rectangular holes face the Wall Panels.

SEC. 5 WINDOW INSTALLATION

HARDWARE REQUIRED

HARDWARE BAG REQUIRED: BYG

Hardware shown at actual size (*Unless indicated otherwise)

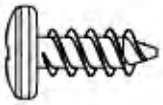

ADZ (x2)
1/4" x 5/8" Pan-Head Screw

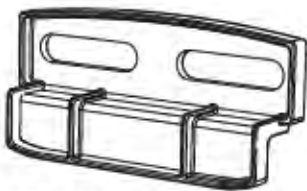

***AIS (x1)**
Window Latch

PLASTIC PARTS REQUIRED

Part shown at 4% of actual size

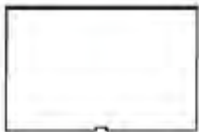

AHE (x1)
Window

TOOLS REQUIRED



Phillips Screwdriver



Safety Glasses



TOOLS AND HARDWARE REQUIRED FOR THIS PAGE

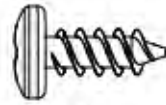
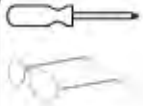

ADZ (x2)

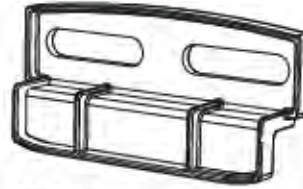

AIS (x1)
(Not to scale)

SEC 5



SEC

5.1

WINDOW INSTALLATION

Insert the **Window (AHE)** down between the ridges of the opening in the Window Wall Panel.

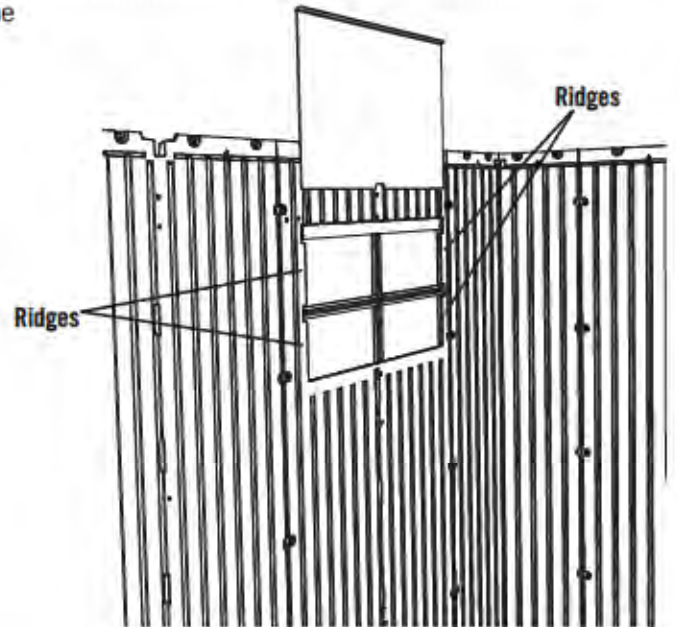

Note: The curved end of the Window goes at the top and faces toward the interior of the Shed.

SEC

5.2

Attach a **Window Latch (AIS)** above the left corner of the Window as shown. When tightening the two (2) 1/4" x 5/8" Pan-Head Screws (**ADZ**), ensure the Window Latch slides freely. **Do not overtighten.**

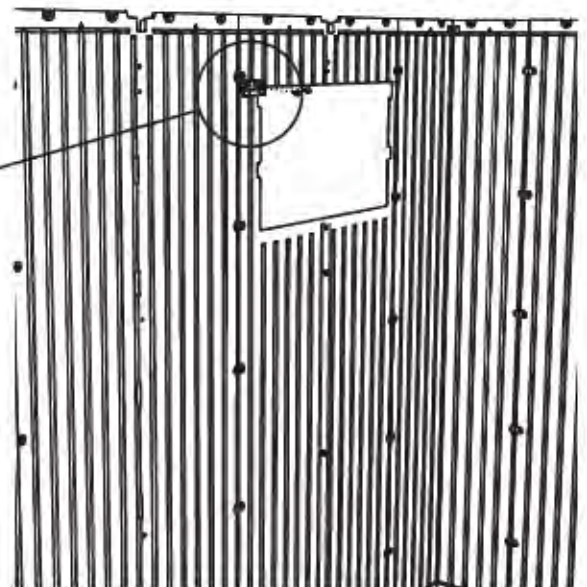
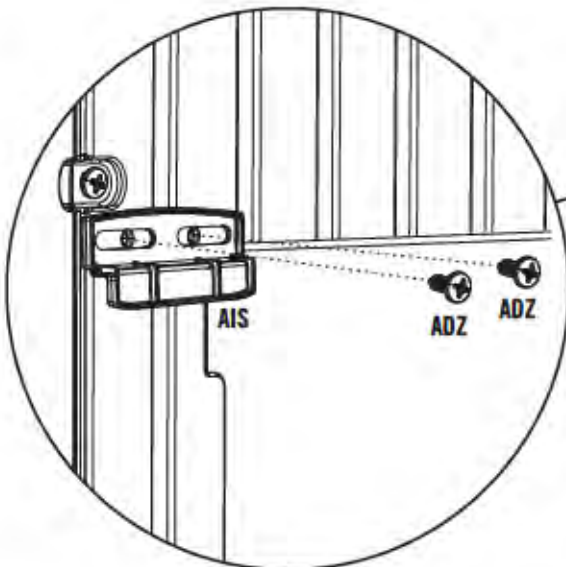

SEC 6 LEFT DOOR ASSEMBLY

HARDWARE REQUIRED

HARDWARE BAG REQUIRED: BYJ

Hardware shown at actual size

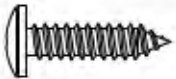

ADW (x5)
#10 x 3/4" Pan-Head Screw

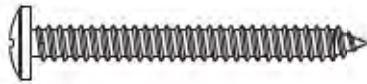

BYZ (x2)
#10 x 1 3/4" Pan-Head Screw

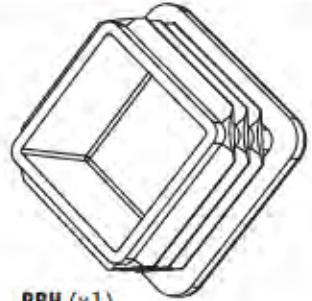

BBH (x1)
1" Square End Cap



AEE (x7)
#10 Flat Washer

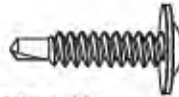

CHK (x1)
#10 x 3/4" Self-Drilling/Self-Tapping Screw



ARA (x1)
1/8" Drill Bit



BZB (x4)
#10 x 1/4" Nylon Spacer

Parts shown at 25% of actual size



BYQ (x2)
Deadbolt Latch



BYP (x2)
Deadbolt Latch Bracket



BYS (x1)
Outer Door Handle



BYR (x1)
Inner Door Handle

METAL PARTS REQUIRED

METAL PARTS KIT REQUIRED: BZD

Part shown at 8% of actual size

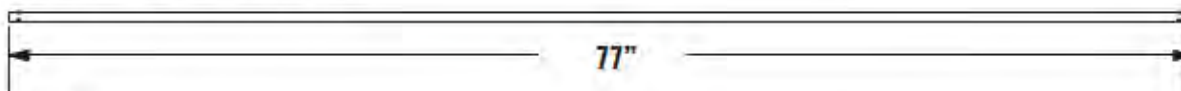

CHN (x1)
Door Hinge Tube

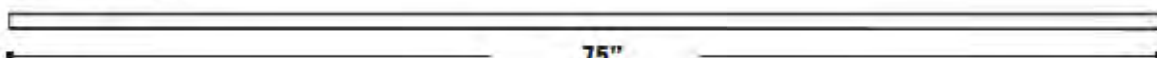

CHI (x1)
Door Square Tube

SEC 6 LEFT DOOR ASSEMBLY (CONT.)

PLASTIC PARTS REQUIRED

Part shown at 4% of actual size

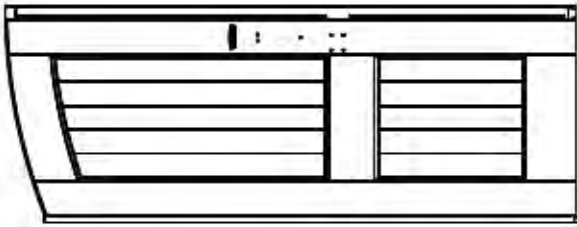

AGO (x1)
Left Door

TOOLS REQUIRED

Phillips
Screwdriver



Plain
Screwdriver



7/16"
Wrench



3/8"
Wrench



Electric Drill



Rubber Mallet



HARDWARE BAG REQUIRED: BYJ

1/8" Drill Bit (ARA) (x1)
(Included)



Safety Glasses





TOOLS AND HARDWARE REQUIRED FOR THIS PAGE

SEC 6

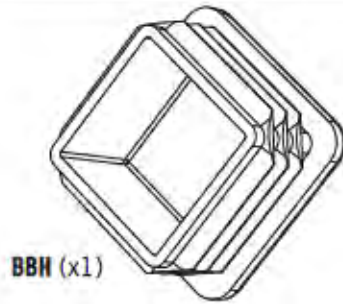

SEC

LEFT DOOR ASSEMBLY

6.1

Rest the **Left Door (AGO)** with the front side down. Slide the **Door Hinge Tube (CHH)** down into the Left Door as shown.

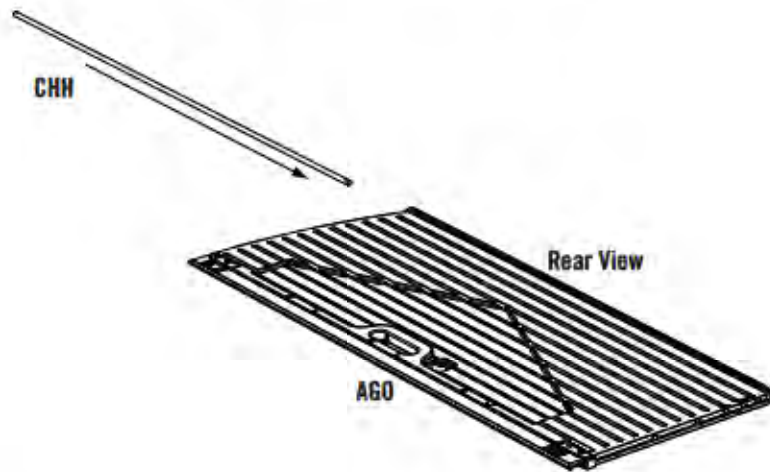

SEC

6.2

Insert a **1" Square End Cap (BBH)** into one of the ends of the **Door Square Tube (CHI)** as shown.

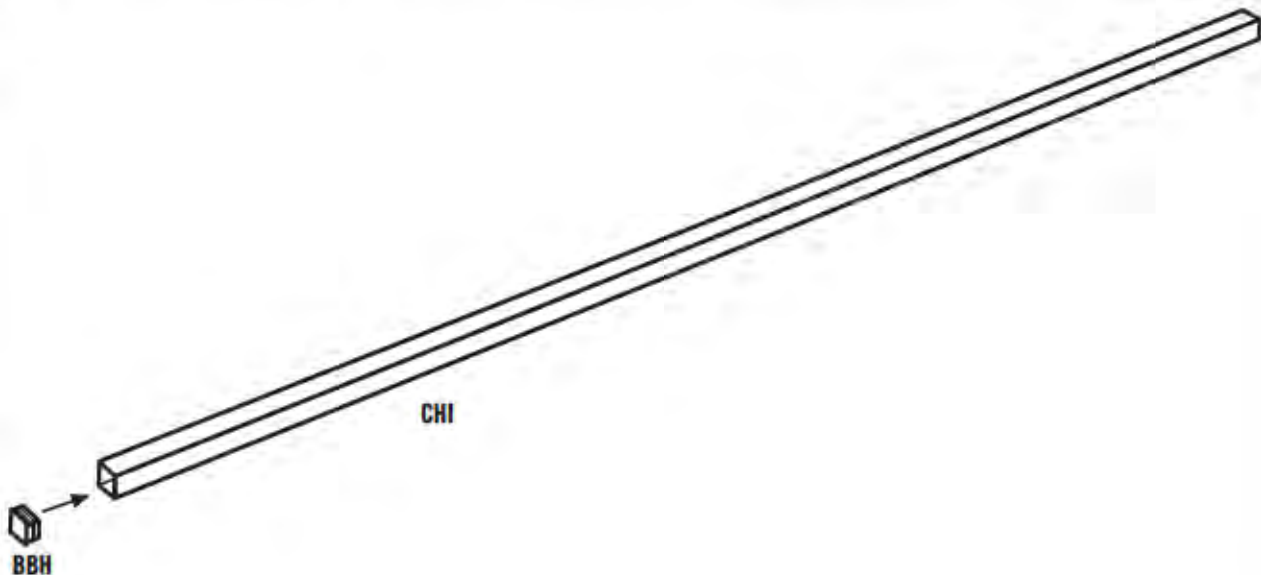



TOOLS AND HARDWARE REQUIRED FOR THIS PAGE

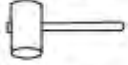

(ARA) (x1)

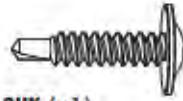

CHK (x1)

SEC 6



SEC

6.3

Slide the Door Square Tube up into the hole at the bottom of the Door until the 1" Square End Cap is flush with the bottom of the Door. Drill an 1/8" hole through the divot on the rear side of the Door and into the Tube. **Do not drill all the way through the Door.** Secure the Door Square Tube in place using one (1) #10 x 3/4" Self-Drilling/Self-Tapping Screw (CHK) at the location shown.

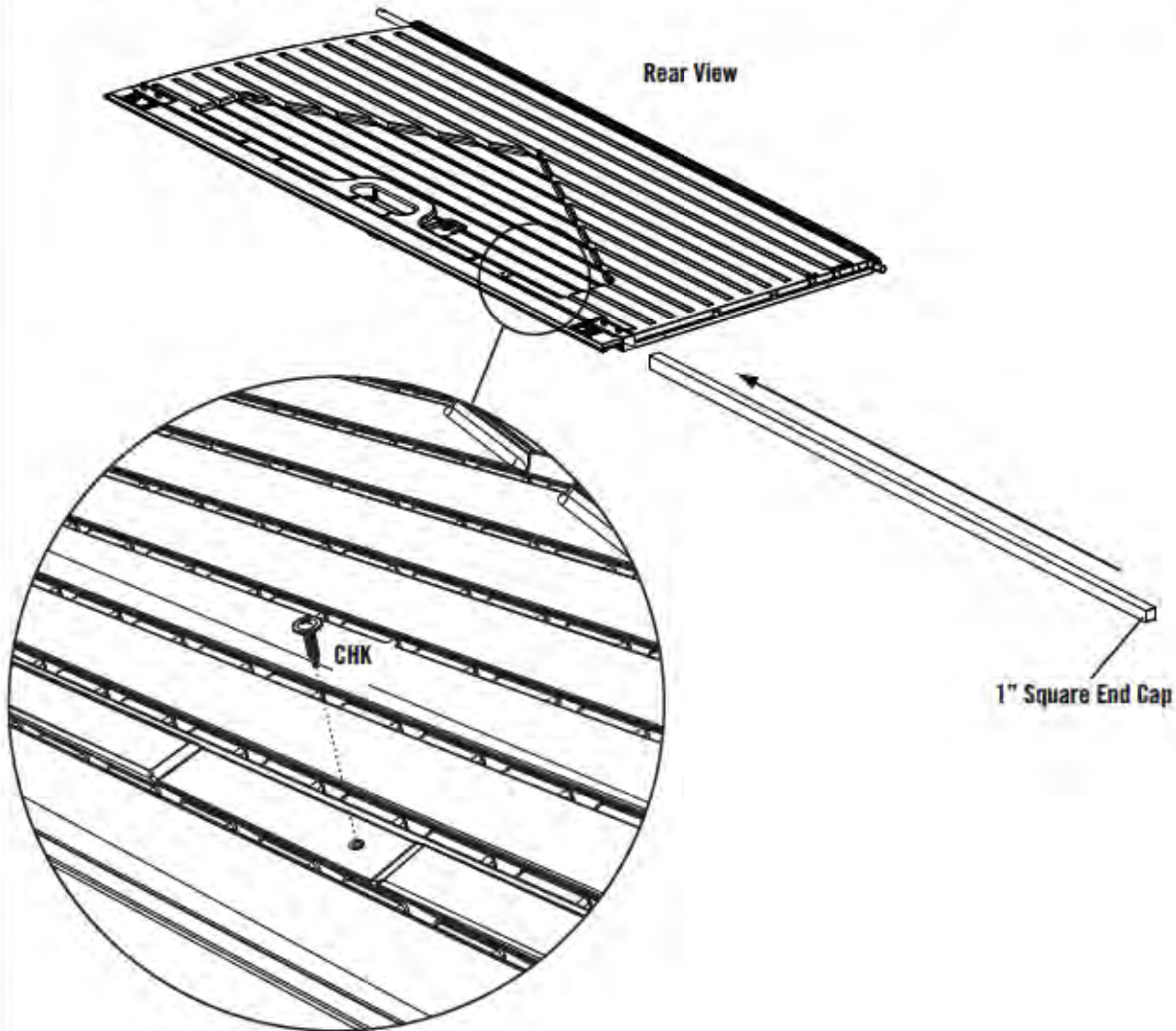

Note: You may need to use a rubber mallet to help insert the Door Square Tube.



TOOLS AND HARDWARE REQUIRED FOR THIS PAGE

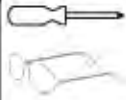

AEE (x3)

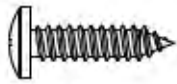

ADW (x1)

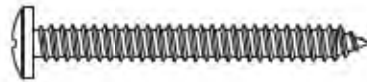

BYZ (x2)



SEC 6

SEC

6.4

Attach the Inner and Outer Door Handles to the Door using two (2) #10 x 1 3/4" Pan-Head Screws (BYZ) and one (1) #10 x 3/4" Pan-Head Screw (ADW) and three (3) #10 Flat Washers (AEE) as shown.

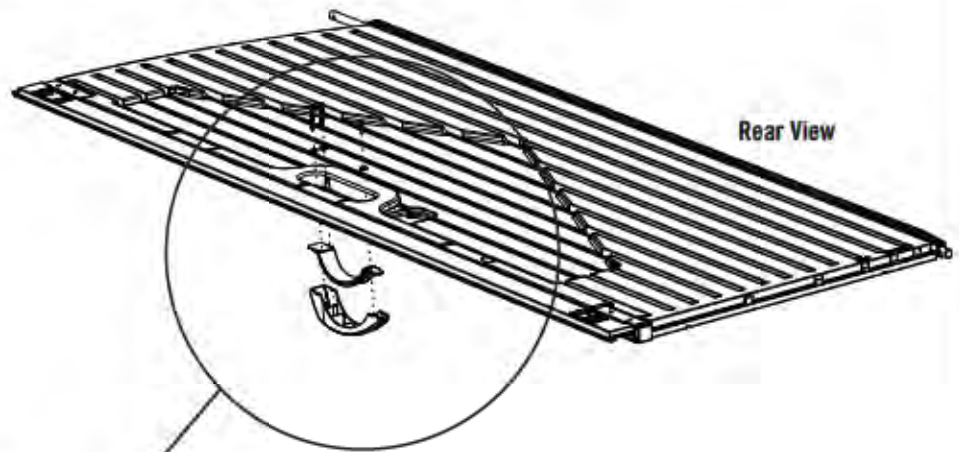

Rear View

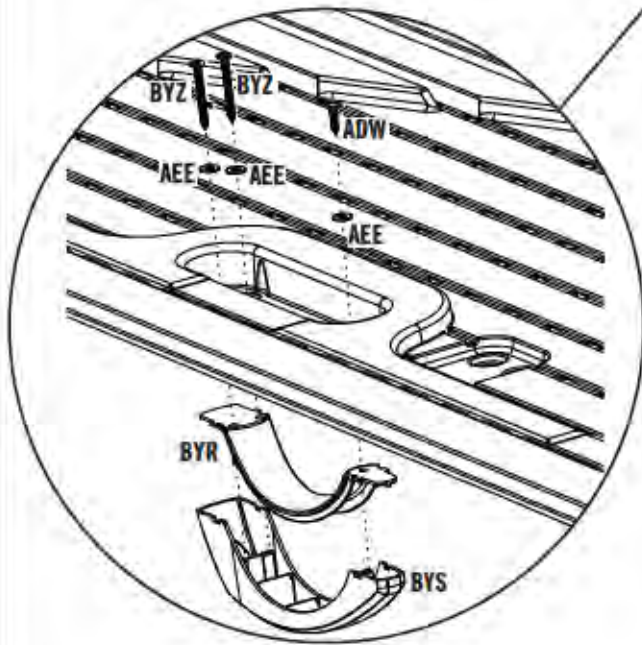



TOOLS AND HARDWARE REQUIRED FOR THIS PAGE

SEC 6

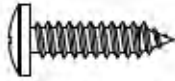

ADW (x4)



AEE (x4)

ARA (x1)



BZB (x4)



SEC

6.5

Using the 1/8" Drill Bit (ARA) (Provided), drill a hole through the plastic of the bottom end of the Left Door and into the metal tube inside the Door at the locations shown. **Do not drill all the way through the Door. Repeat this step for the top end of the Left Door.**

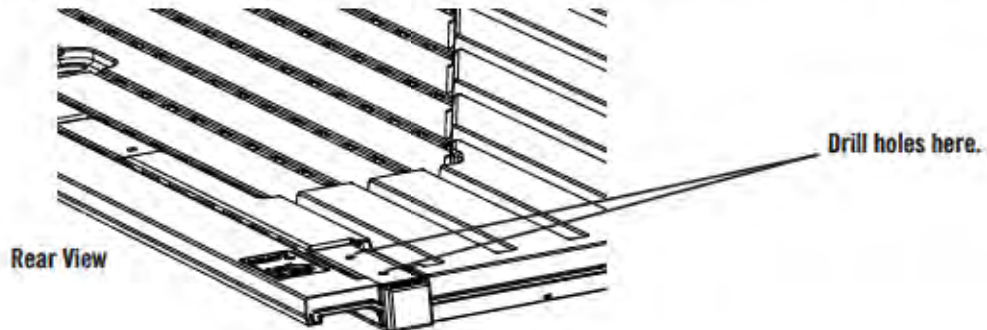

SEC

6.6

Connect a Deadbolt Latch Bracket (BYP) and Deadbolt Latch (BYQ) to the top of the Door as shown using the required hardware. **Repeat this step for the bottom of the Door.**

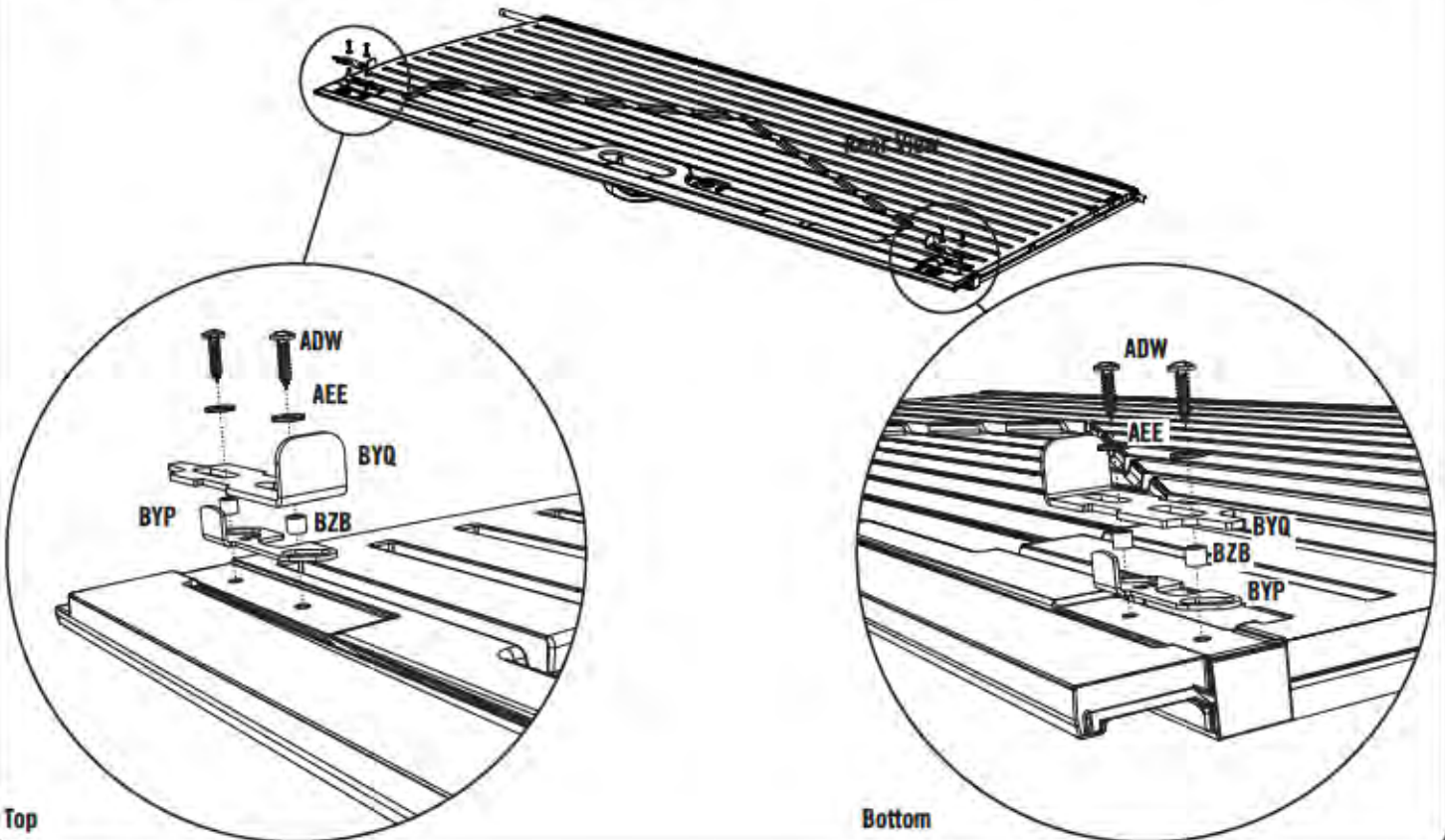

SEC 7 RIGHT DOOR ASSEMBLY

HARDWARE REQUIRED

HARDWARE BAG REQUIRED: BYK

Hardware shown at actual size

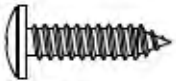

ADW (x1)
#10 x 3/4" Pan-Head Screw

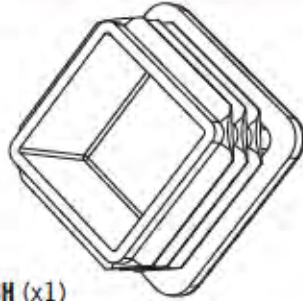

BBH (x1)
1" Square End Cap

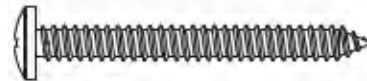

BYZ (x2)
#10 x 1 3/4" Pan-Head Screw



AEE (x1)
#10 Flat Washer

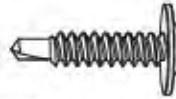

CHK (x1)
#10 x 3/4" Self-Drilling/Self-Tapping Screw

Part shown at 50% of actual size



BBI (x1)
Inside Door Handle

Parts shown at 25% of actual size



BYR (x1)
Inner Handle



BYS (x1)
Outer Handle

METAL PARTS REQUIRED

Part shown at 8% of actual size



CHH (x1)
Door Hinge Tube



CHI (x1)
Door Square Tube

PLASTIC PARTS REQUIRED

Part shown at 4% of actual size

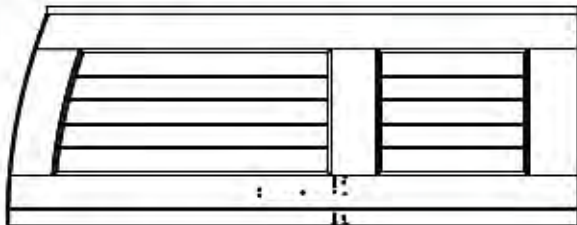

AGZ (x1)
Right Door

TOOLS REQUIRED

HARDWARE BAG REQUIRED: BYJ

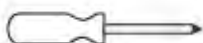

Phillips Screwdriver



7/16" Wrench



Electric Drill

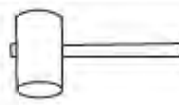

Rubber Mallet



1/8" Drill Bit (ARA) (x1)
(Included)



Safety Glasses



TOOLS AND HARDWARE REQUIRED FOR THIS PAGE

SEC 7

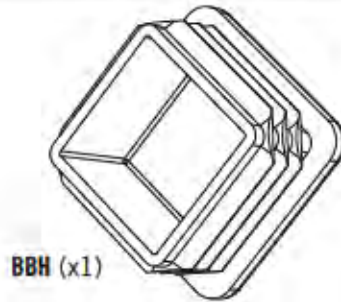

SEC

RIGHT DOOR ASSEMBLY

7.1

Rest the **Right Door (AGZ)** with the front side down. Slide the **Door Hinge Tube (CHH)** down into the Right Door as shown.



SEC

7.2

Insert a 1" Square End Cap (BBH) into one of the ends of the Door Square Tube (CHI) as shown.

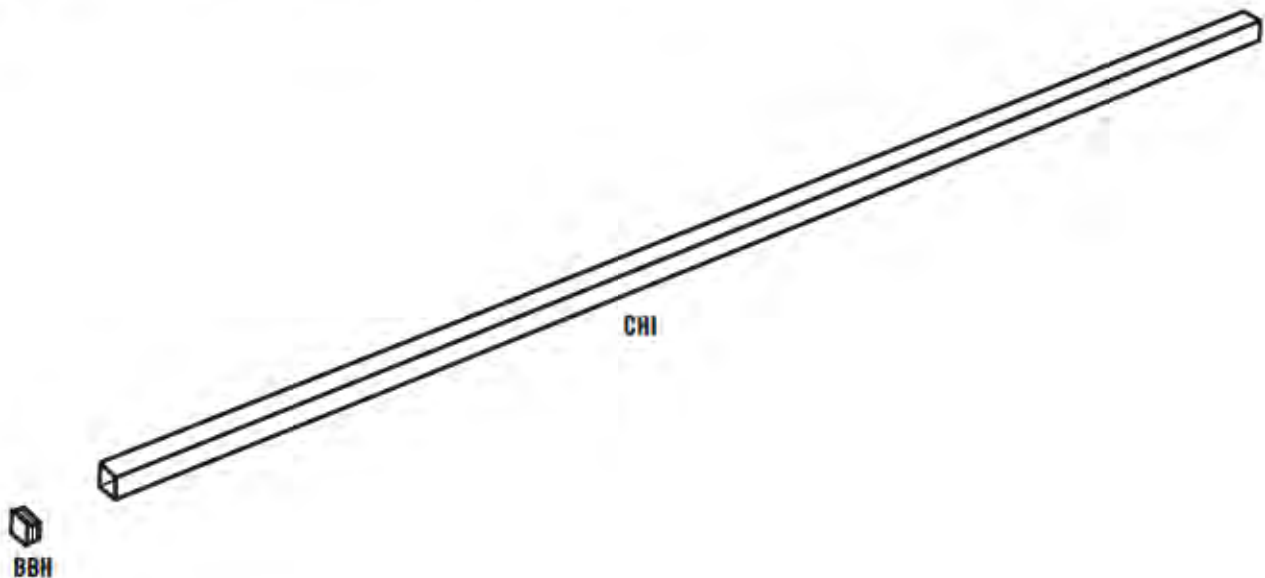



TOOLS AND HARDWARE REQUIRED FOR THIS PAGE

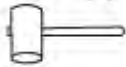

(ARA) (x1)

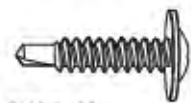

CHK (x1)

SEC 7



SEC

7.3

Slide the Door Square Tube up into the hole at the bottom of the Door until the 1" Square End Cap is flush with the bottom of the Door. Drill an 1/8" hole through the divot on the rear side of the Door and into the Tube. **Do not drill all the way through the Door.** Secure the Door Square Tube in place using one (1) #10 x 3/4" Self-Drilling/Self-Tapping Screw (CHK) at the location shown.

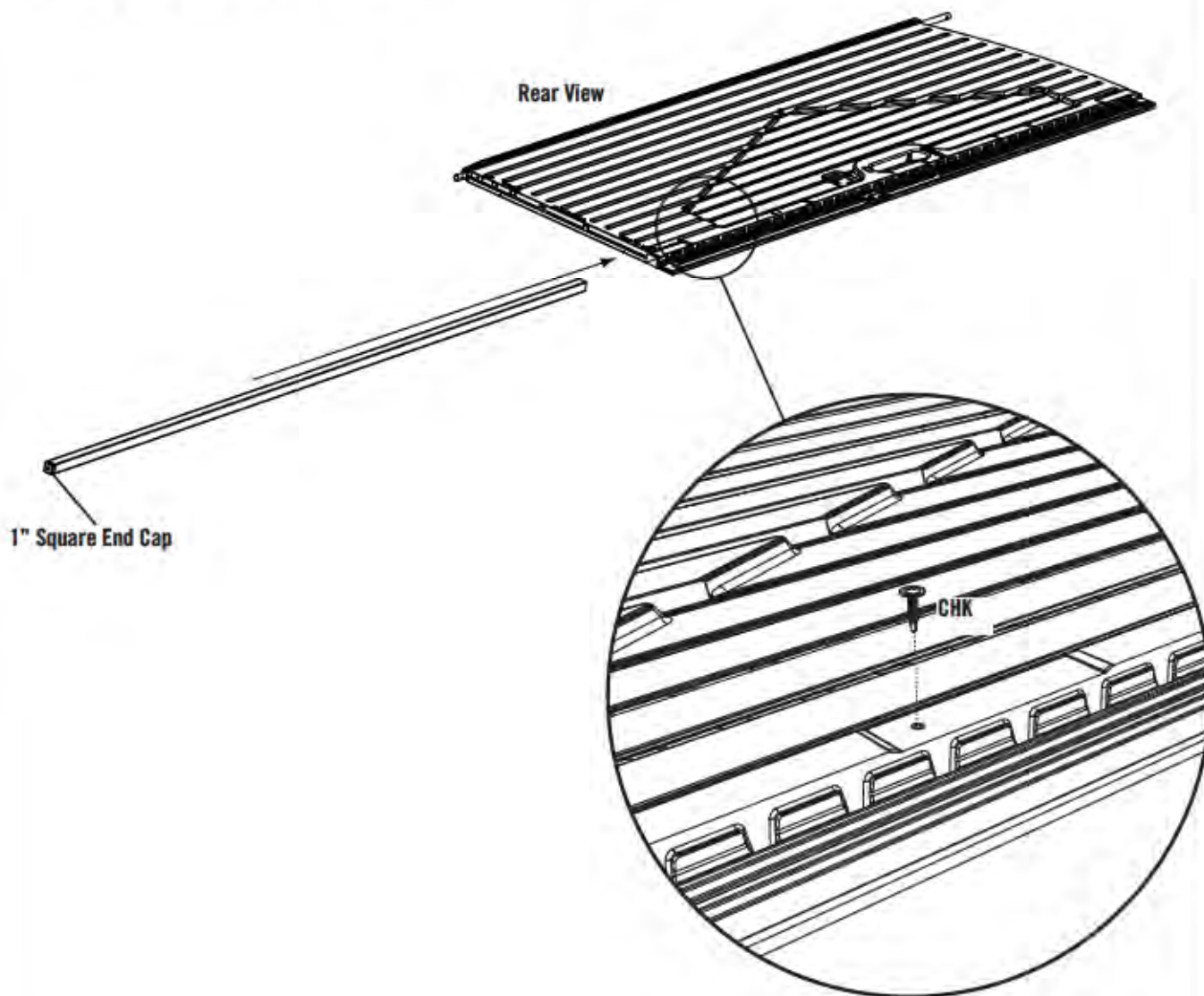

Note: You may need to use a rubber mallet to help insert the Door Square Tube.



TOOLS AND HARDWARE REQUIRED FOR THIS PAGE

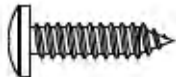
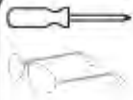

ADW (x1)

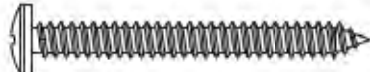

BYZ (x2)



AEE (x1)



BBI (x1)
(Not to scale)

SEC 7



SEC

7.4

Connect the **Inner and Outer Handles (BYR & BYS)** and **Inside Handle (BBI)** to the Door using the required hardware. Set aside.

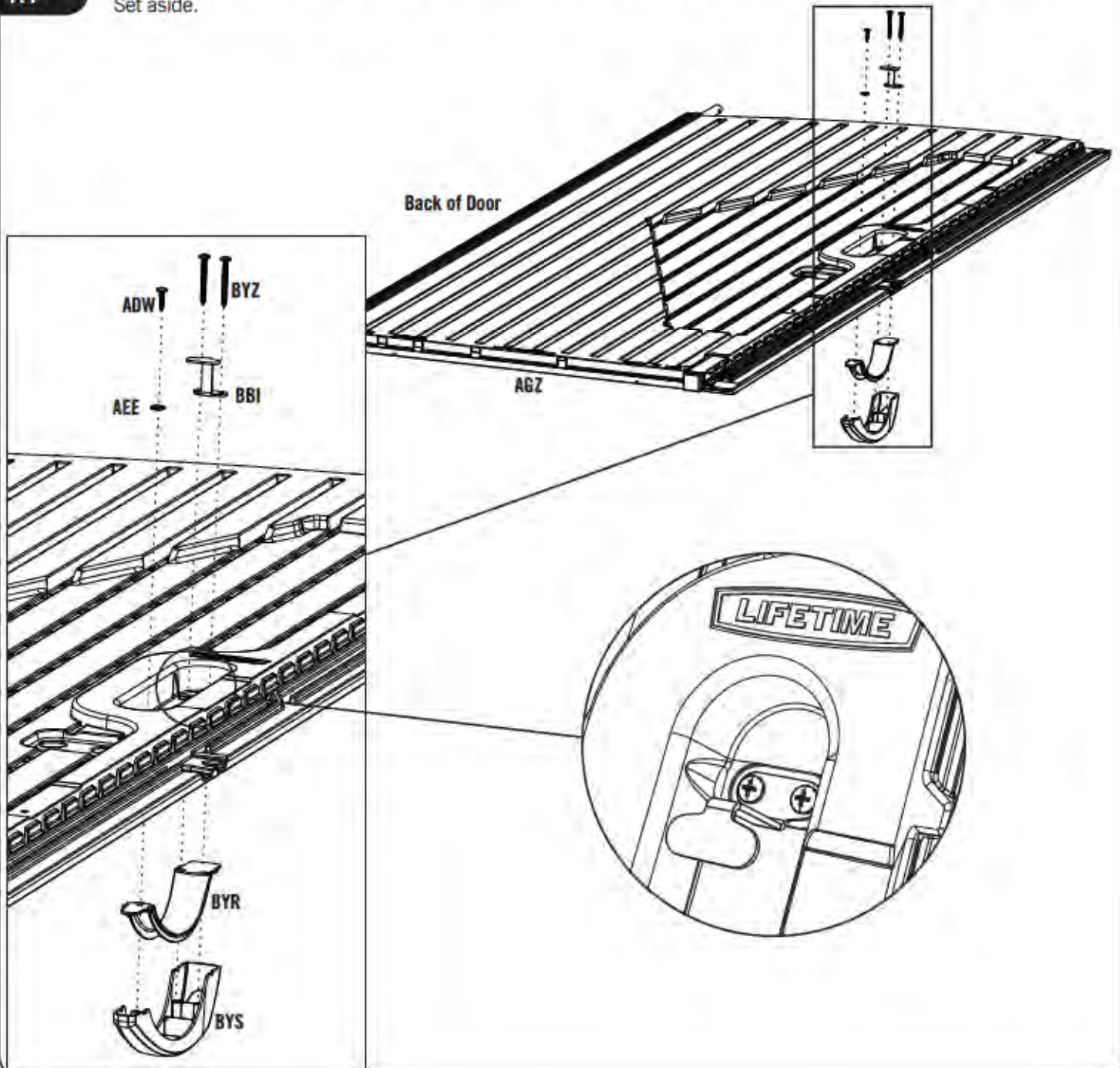

SEC 8 GABLE ASSEMBLY

HARDWARE REQUIRED

HARDWARE BAG REQUIRED: BYF

Hardware shown at actual size

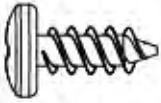

ADZ (x3)
1/4" x 5/8" Pan-Head Screw

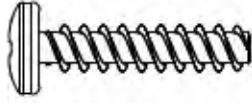

ADV (x6)
1/4" x 1 1/8" Pan-Head Screw

METAL PARTS REQUIRED

Part shown at 8% of actual size

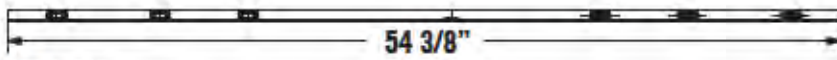

AFE (x1)
Entry Header Bar

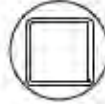

PLASTIC PARTS REQUIRED

Parts shown at 4% of actual size



AGF (x1)
Entry Gable

(Front View)



AGH (x1)
Rear Gable 1

(Rear View)



AGI (x1)
Rear Gable 2

(Rear View)

TOOLS REQUIRED



Phillips Screwdriver



Safety Glasses



TOOLS AND HARDWARE REQUIRED FOR THIS PAGE

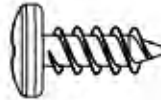

ADZ (x3)

SEC 8



SEC

8.1

REAR GABLE ASSEMBLY

Lay **Rear Gable 2 (AGI)** flat on the ground with the rear side facing up. Lay the edge of **Rear Gable 1 (AGH)** over **Rear Gable 2** as shown, and align the three holes.

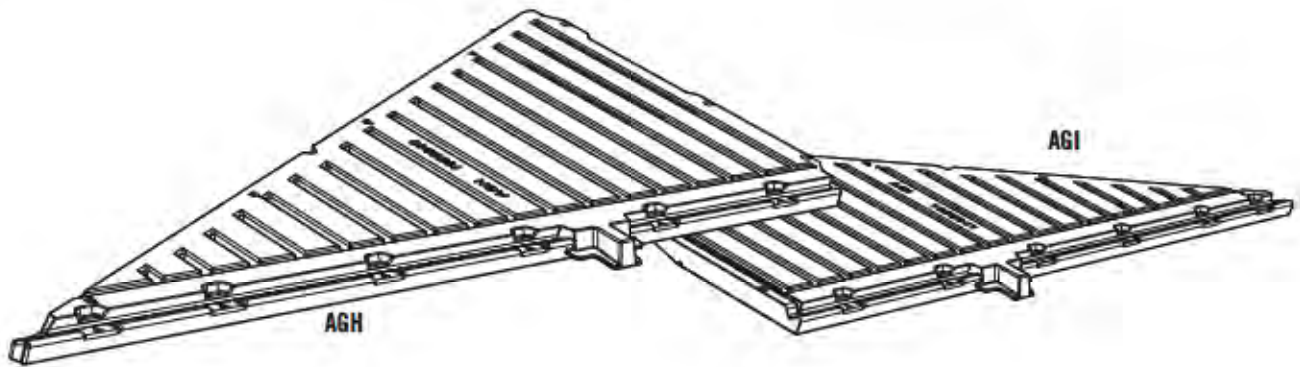

SEC

8.2

Connect **Rear Gables 1 & 2** together using three (3) **1/4" x 5/8" Pan-Head Screws (ADZ)** as shown. Set aside.

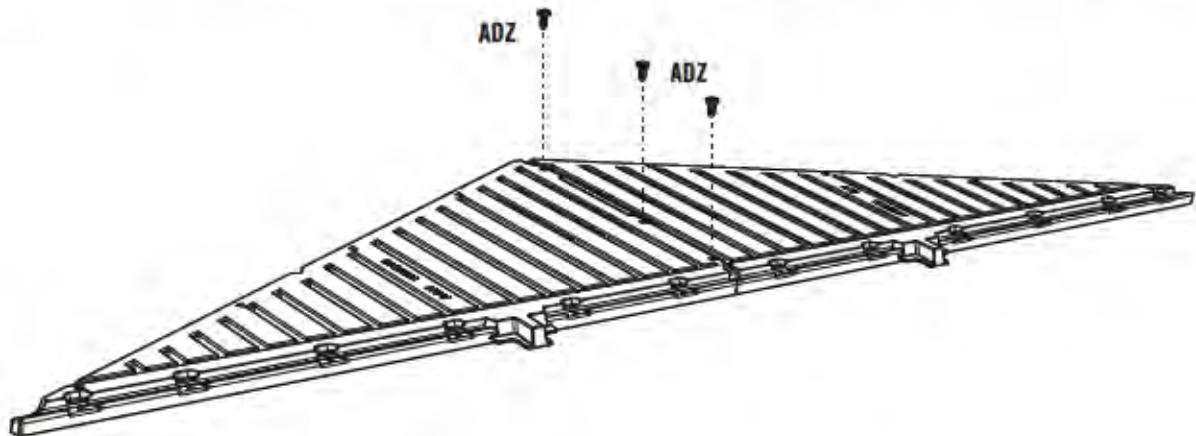

Note: Only use a hand screwdriver in this step.



TOOLS AND HARDWARE REQUIRED FOR THIS PAGE

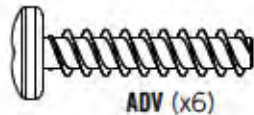
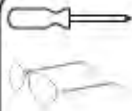

ADV (x6)



SEC 8

SEC

8.3

ENTRY GABLE ASSEMBLY

Lay the **Entry Gable Assembly (AGF)** flat on the ground with the rear side facing up. Place the **Header Bar (AFE)** over the Entry Gable Assembly and align the six (6) holes in the Header Bar with those in the Entry Gable Assembly as shown.

The indented, rectangular holes face toward the Gable.

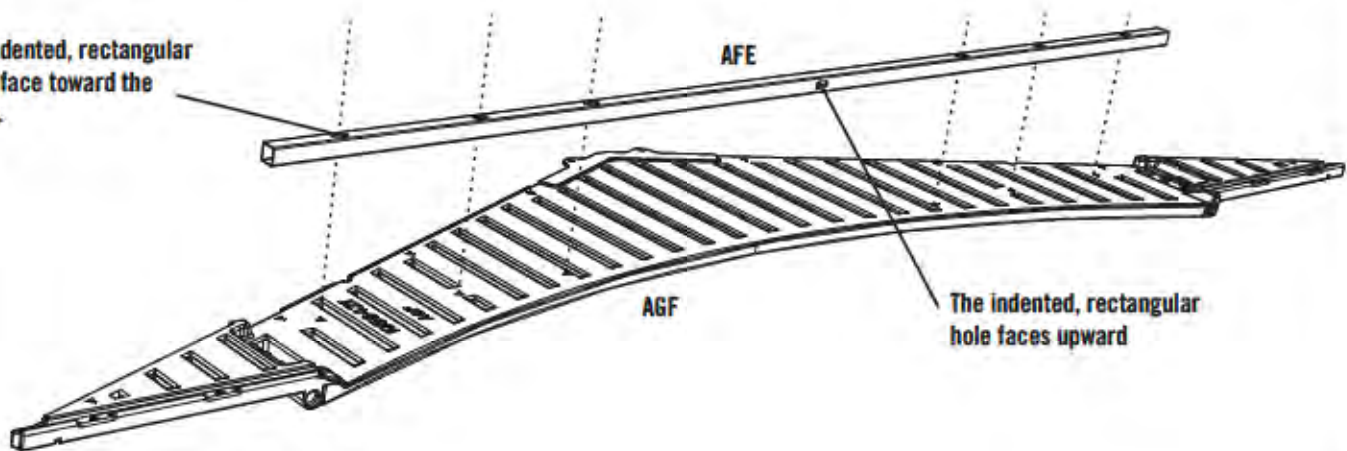

SEC

8.4

Attach the Entry Header Bar to the Entry Gable Assembly, and secure with six (6) 1/4" x 1/8" Pan-Head Screws (ADV). Set aside.

The indented, rectangular holes face toward the Gable.

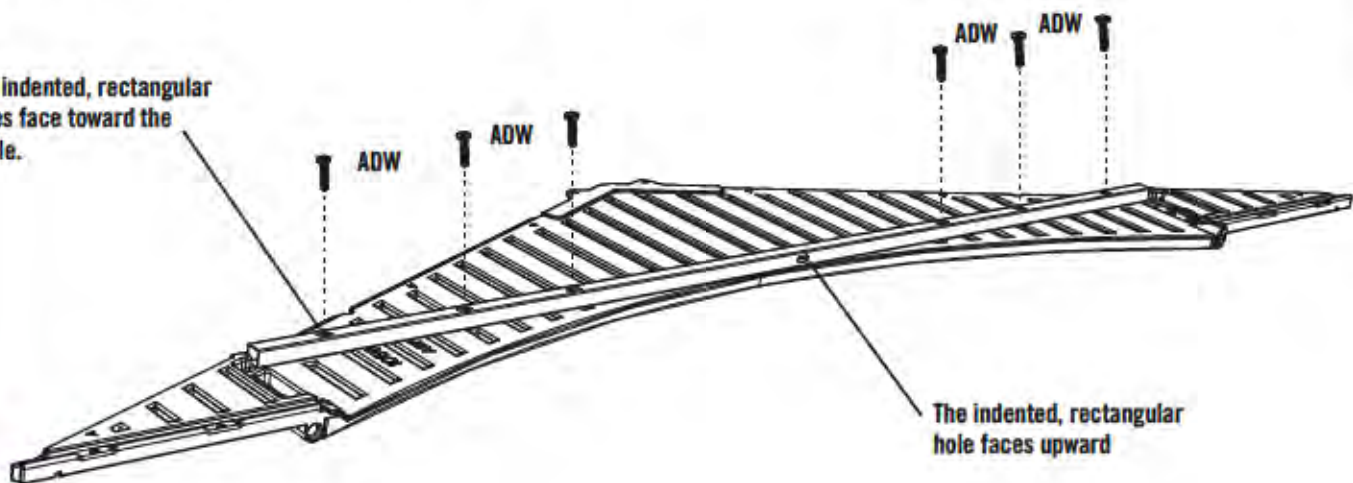

Note: Only use a hand screwdriver in this step.

SEC 9 DOOR & ENTRY GABLE INSTALLATION

HARDWARE REQUIRED

Hardware shown at actual size (*Unless noted otherwise)

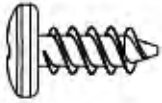

ADZ (x17)
1/4" x 5/8" Pan-Head Screw



AHP (x2)
Cotter Pin



ADJ (x5)
1/4" Cap Nut

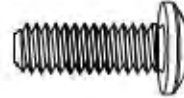

BFY (x5)
1/4" x 3/4" Pan-Head Screw

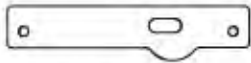

***BYM (x1)**
Strike Plate



BXZ (x16)
1/4" Nylon Washer

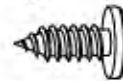

ADX (x2)
#10 x 1/2" Pan-Head Screw

METAL PARTS REQUIRED

Parts shown at 8% of actual size

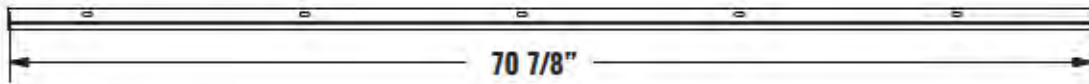

BYA (x1)
Left Angled Door Jamb



BYB (x1)
Right Angled Door Jamb

PLASTIC PARTS REQUIRED

Parts shown at 4% of actual size



Entry Gable Assembly Front View

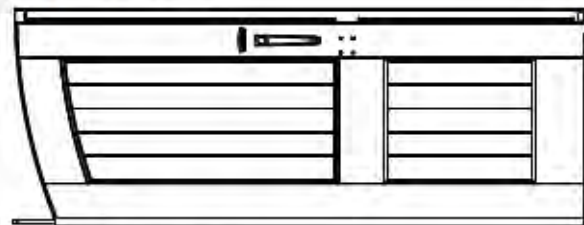

Left Door Assembly

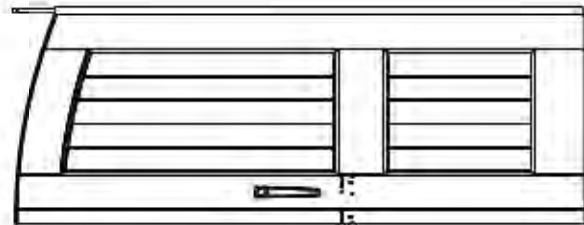

Right Door Assembly

TOOLS REQUIRED

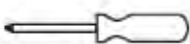

Phillips Screwdriver



Pliers



Safety Glasses



TOOLS AND HARDWARE REQUIRED FOR THIS PAGE



7/16"



BXZ (x6)

SEC 9



SEC

9.1

DOOR INSTALLATION

Align the six holes in the **Right Angled Door Jamb (BYB)** with the six holes along the edge of the right, front Corner Wall Panel. Starting at the bottom of the Door Jamb, secure the Door Jamb to the Wall Panel using six (6) 1/4" x 5/8" Pan-Head Screws (ADZ) and six (6) 1/4" Nylon Washers (BXZ). Leave the top-most hole empty for now.

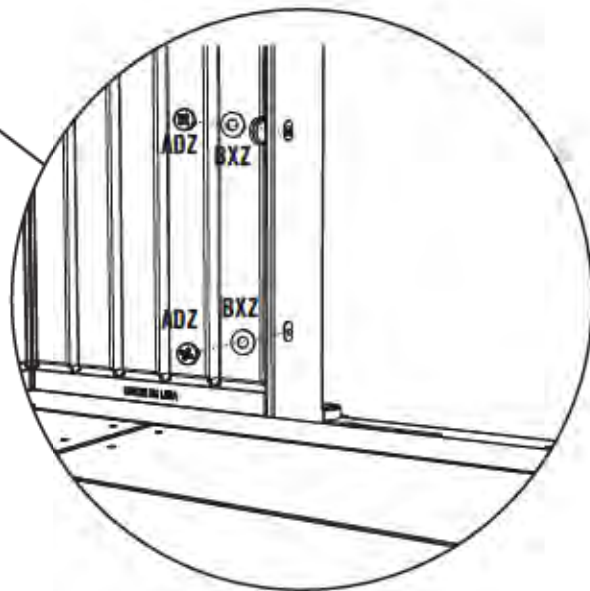
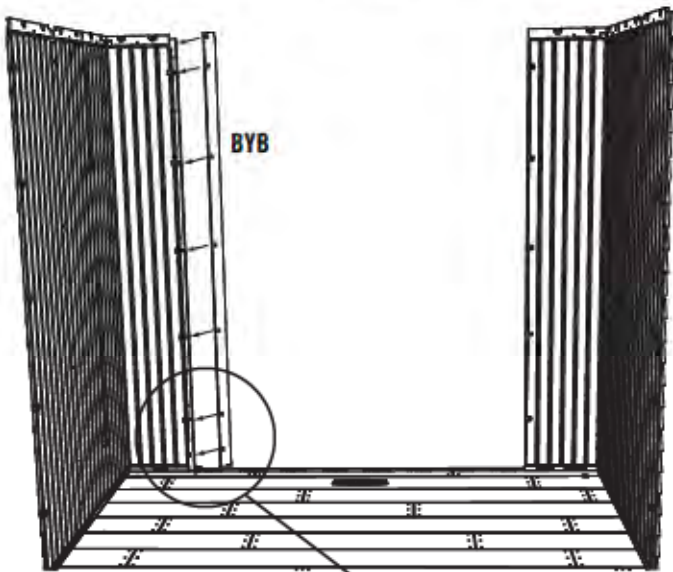



TOOLS AND HARDWARE REQUIRED FOR THIS PAGE

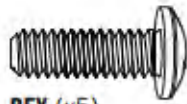
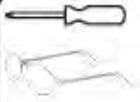

BFY (x5)



BXZ (x10)



ADJ (x5)

SEC 9



SEC

9.2

Align the five holes in the **Left Angled Door Jamb (BYA)** with the five holes along the edge of the left, front Corner Wall Panel. Secure the Door Jamb to the Wall Panel using five (5) 1/4" x 3/4" Pan-Head Screws (ADZ), ten (10) 1/4" Nylon Washers (BXZ), and five (5) 1/4" Cap Nuts (ADJ).

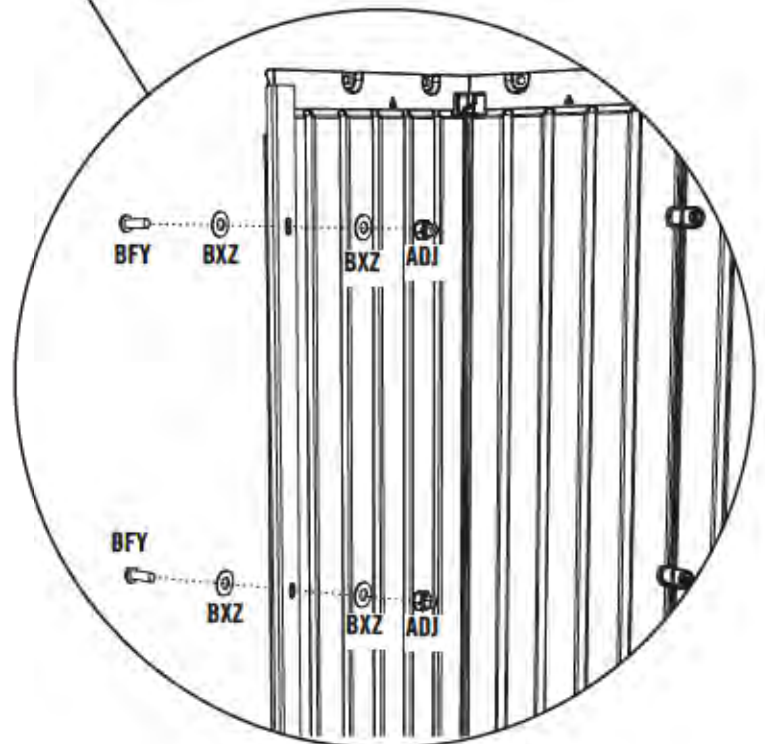
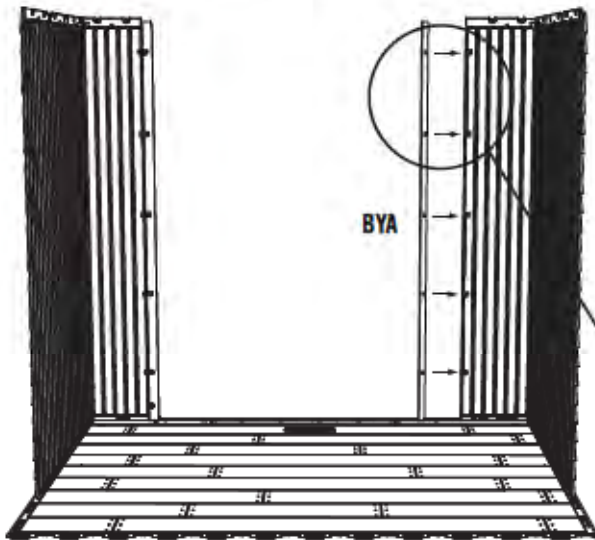



TOOLS AND HARDWARE REQUIRED FOR THIS PAGE



AHP (x2)



SEC 9

SEC

9.3

Align the hole in the bottom of the Hinge of the **Left Door Assembly** with the slit in the Door Hinge Bushing on the Floor of your shed, and insert the Door Hinge Tube into the Door Hinge Bushing.

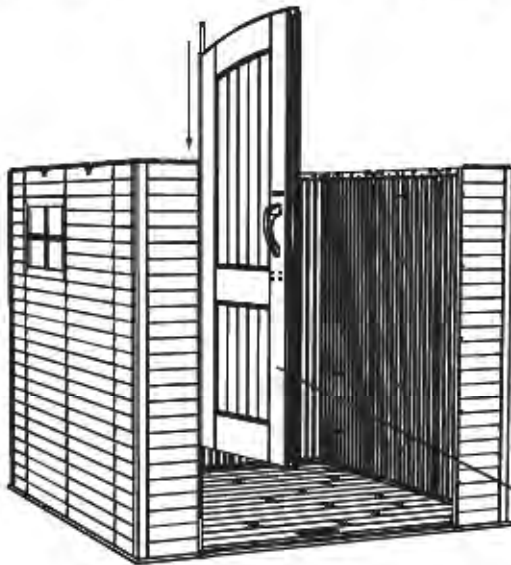

Left Door Assembly

SEC

9.4

Insert a **Cotter Pin (AHP)** through the slit in the Bushing and hole in the Door Hinge. Use a pair of pliers to bend the ends of the Cotter Pin outward. **Repeat these steps for the Right Door Assembly.**

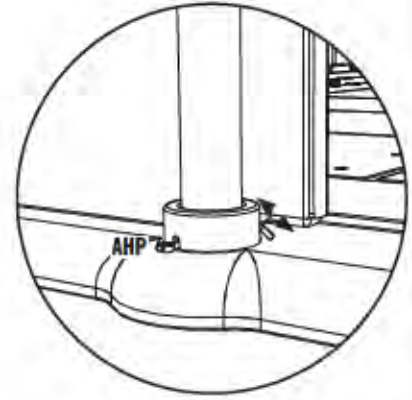
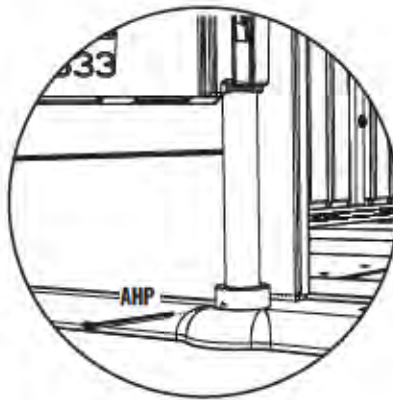
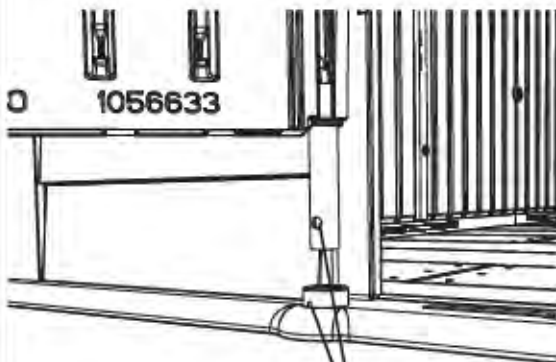

Note: Ensure that these two holes line up, so that the Cotter Pin (AHP) can be inserted.



Note: Use pliers to bend back the ends of the Cotter Pin (AHP).



TOOLS AND HARDWARE REQUIRED FOR THIS PAGE



ADZ (x5)

SEC 9



2 ADULTS REQUIRED FOR THE STEPS ON THIS PAGE

SEC

ENTRY GABLE INSTALLATION

9.5

Slide the two holes in the **Entry Gable Assembly** down over the Door Hinge Tube of both Doors as shown.

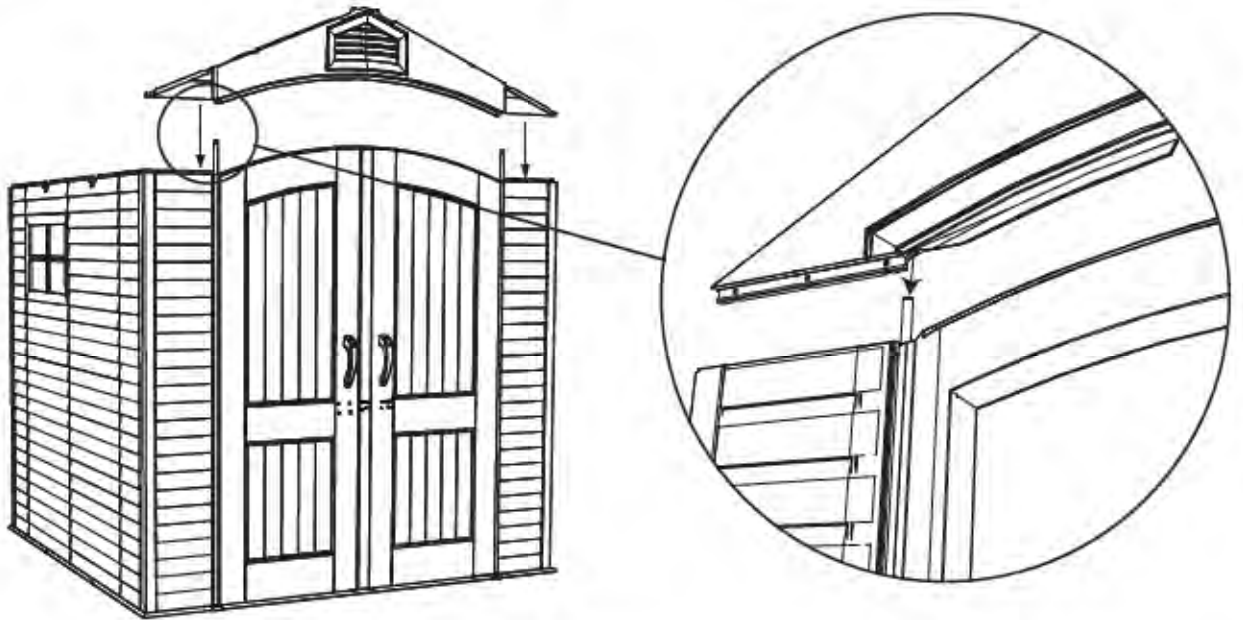

SEC

9.6

Align the holes in the sides of the Entry Gable Assembly with those in the tops of the Corner Wall Panels, and secure with four (4) $1/4" \times 5/8"$ Pan Head Screws (ADZ) at the locations indicated. Secure the top of the Right Angled Door Jamb to the Entry Gable using one (1) $1/4" \times 5/8"$ Pan Head Screws (ADZ).

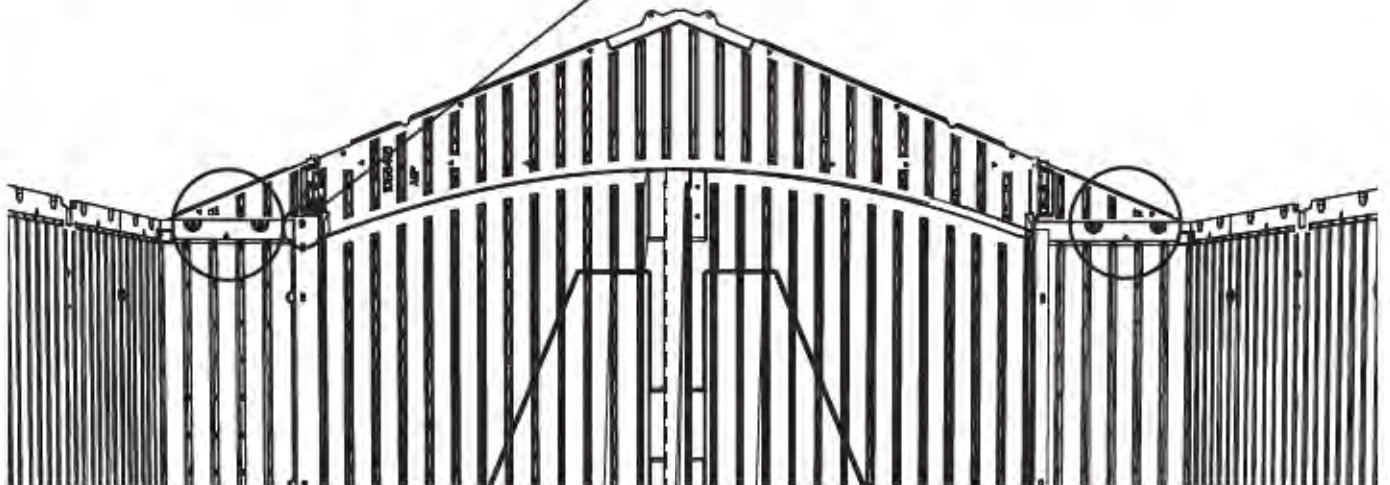



TOOLS AND HARDWARE REQUIRED FOR THIS PAGE

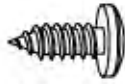
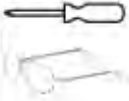

ADX (x2)

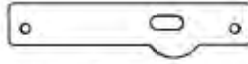

BYM (x1)
(Not to scale)

SEC 9



SEC

9.7

Secure the **Strike Plate (BYM)** to the Floor over the slot next to the **Right Door** as shown using two (2) **#10 x 1/2" Pan-Head Screws (ADX)**. Do not overtighten.

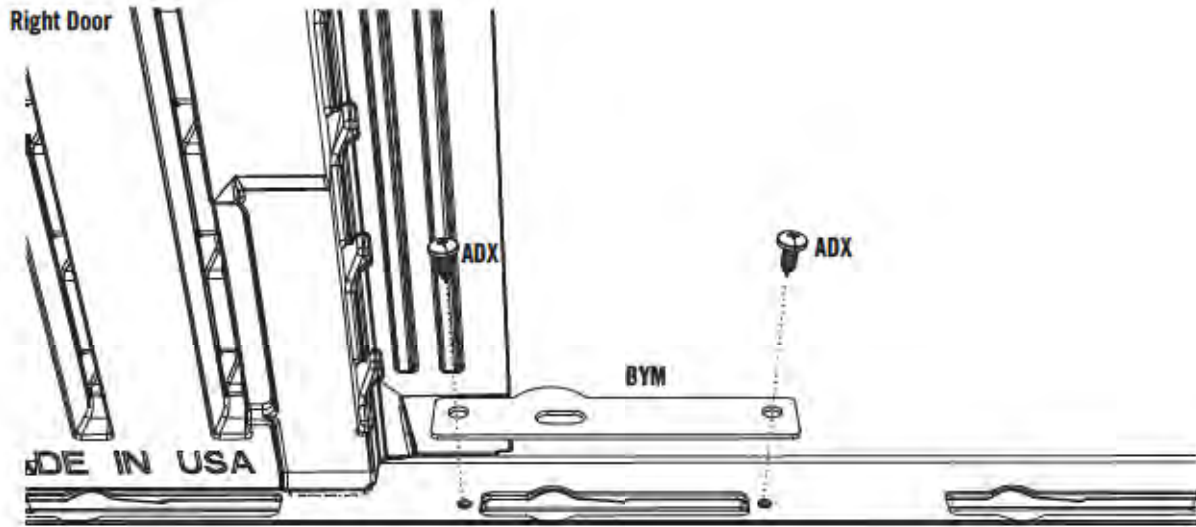

Interior View Looking Out

SEC 10 TRUSS, REAR GABLE, & ROOF INSTALLATION

HARDWARE REQUIRED (BYL)

Hardware shown at actual size

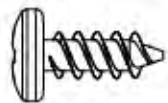

ADZ (x91)
1/4" x 5/8" Pan-Head Screw
(Not all screws will be used)



BYT (x16)
Gable-to-Roof Clip

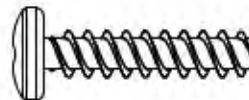

ADV (x24)
1/4" x 1 1/8" Pan-Head Screw

METAL PARTS REQUIRED

Parts shown at 15% of actual size

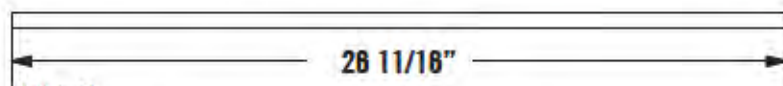

BYY (x6)
Roof Support Tube



Truss Assembly (x2)

METAL PARTS KIT REQUIRED: BZD

PLASTIC PARTS REQUIRED

Parts shown at 4% of actual size



BYV (x1)
Skylight

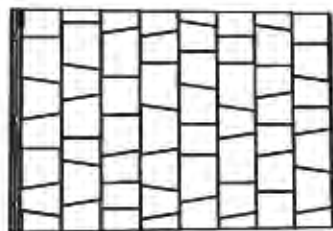

AGQ (x6)
Roof Panel



Rear Gable Assembly (Rear View)

SMALL PARTS BOX REQUIRED: BYU

Parts shown at 25% of actual size

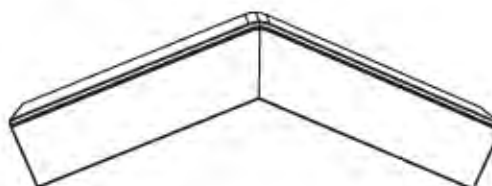

BYW (x2)
Roof End Cap



BYX (x4)
Roof End Cap Filter

TOOLS REQUIRED

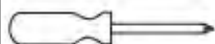

Phillips Screwdriver



Flashlight



Safety Glasses



TOOLS AND HARDWARE REQUIRED FOR THIS PAGE

SEC 10

NO HARDWARE REQUIRED FOR THIS STEP



3 ADULTS REQUIRED FOR THIS SECTION

SEC

10.1

TRUSS & ROOF INSTALLATION

Snap a **Roof Support Tube (BYY)** into the grooves at the center of the underside of a **Roof Panel (AGQ)** as shown. Repeat this step for each **Roof Panel**.

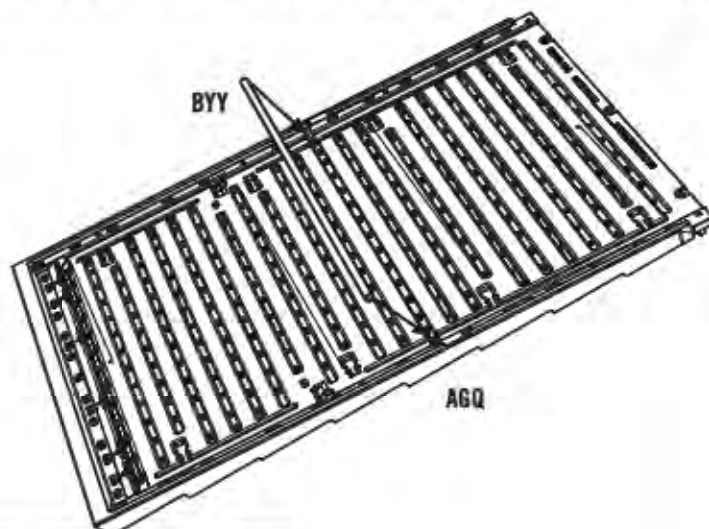

! *Note: Ensure to carefully read and follow the roof installation instructions and notes. Following each step in the order listed will minimize potential complications during installation.*

SEC

10.2

Place the ends of a **Truss Assembly** into the notches at the tops of opposite **Wall Panels** as shown. While one adult holds the **Truss Assembly** in place, set a **Roof Panel** onto the **Truss Assembly** and **Front Gable**. **The edge of the Roof Panel fits down inside the Truss Channel.**

A truss notch is located at the top center of each **Wall Panel**.





TOOLS AND HARDWARE REQUIRED FOR THIS PAGE

SEC 10

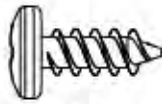

ADZ (x8)



BYT (x8)



SEC

10.3

Insert the **Gable-to-Roof Clips (BYT)** into the slots on the edge of the Roof Panel and slide the Clips up against the Entry Gable.

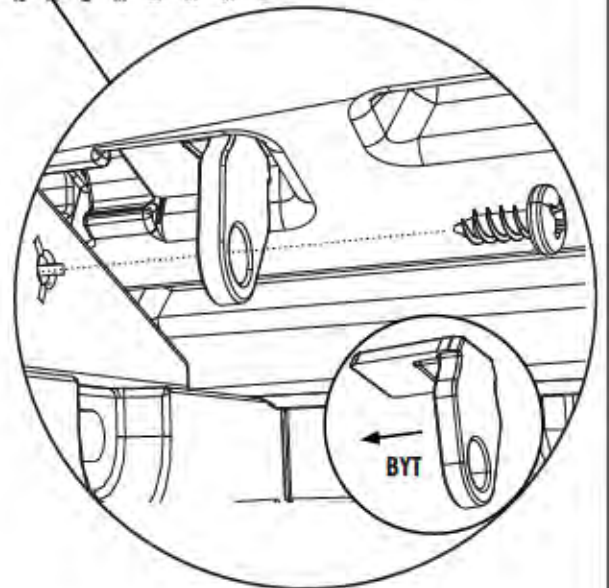
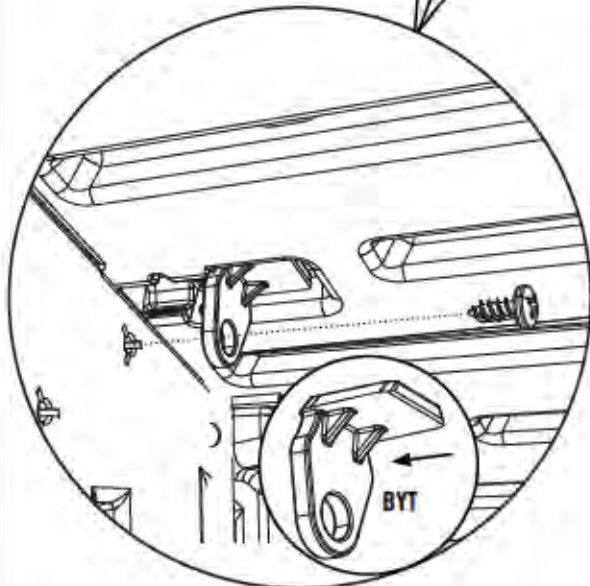

Note: The Gable-to-Roof Clips at the ends of the Entry Gable slide in backwards.



TOOLS AND HARDWARE REQUIRED FOR THIS PAGE

SEC 10

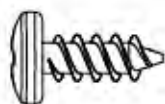
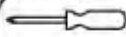

ADZ (x8)

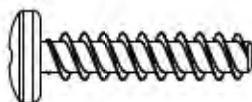

ADV (x8)



SEC

10.4

Secure the Roof Panels to the Truss and Wall Panels using four (4) 1/4" x 5/8" Pan-Head Screws (ADZ) and four (4) 1/4" x 1 1/8" Pan-Head Screws (ADV). Repeat steps 10.3 - 10.4 for the other front Roof Panel.

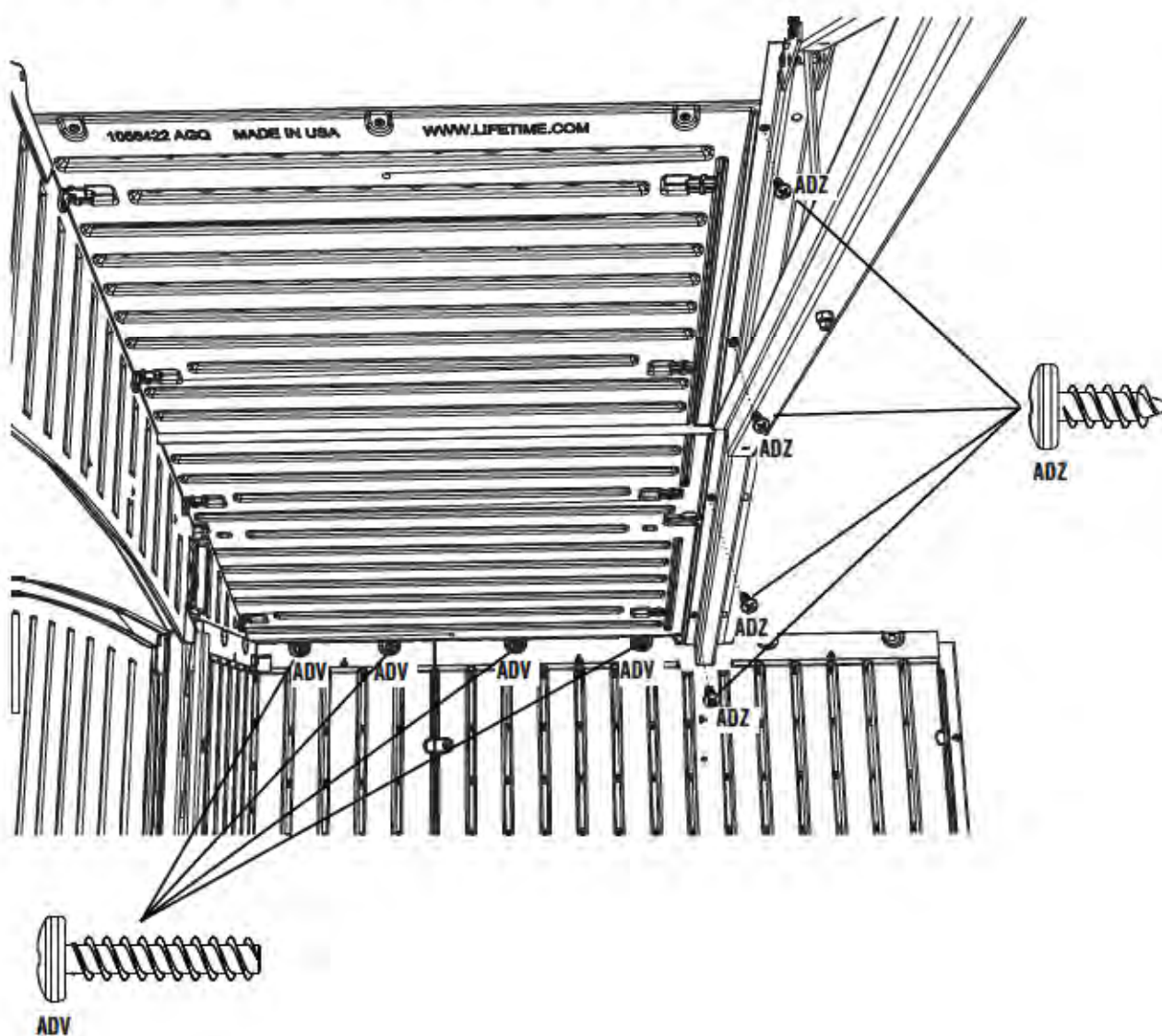



TOOLS AND HARDWARE REQUIRED FOR THIS PAGE

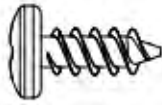

ADZ (x16)

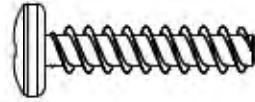

ADZ (x8)

SEC 10



SEC

10.5

Place the ends of the second **Truss Assembly** into the notches at the tops of the next set of opposite **Wall Panels** as shown. While one adult holds the **Truss Assembly** in place, set a **Roof Panel** between the two **Truss Assemblies**. The edge of the **Roof Panel** fits down inside the **Truss Channel**. Secure the **Roof Panel** to the **Truss Assemblies** as you did in the previous step. **Repeat this process for the second center Roof Panel.**

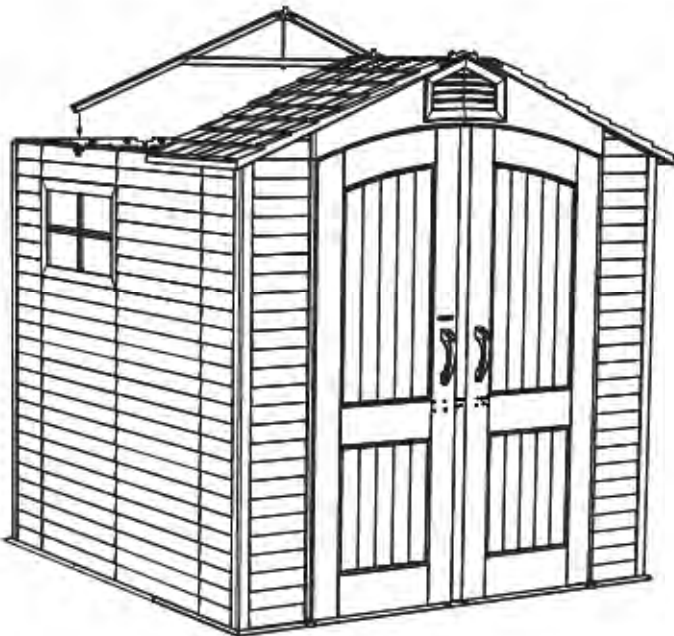

Note: Use the Screws (ADZ) to connect the tops of the Wall Panels to the bottom of the Roof Panels.



TOOLS AND HARDWARE REQUIRED FOR THIS PAGE

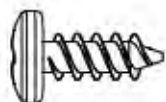
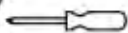

ADZ (x12)

SEC 10



SEC

10.6

Attach the Rear Gable Assembly to tops of the rear Wall Panels using twelve (12) 1/4" x 5/8" Pan-Head Screws (ADZ).

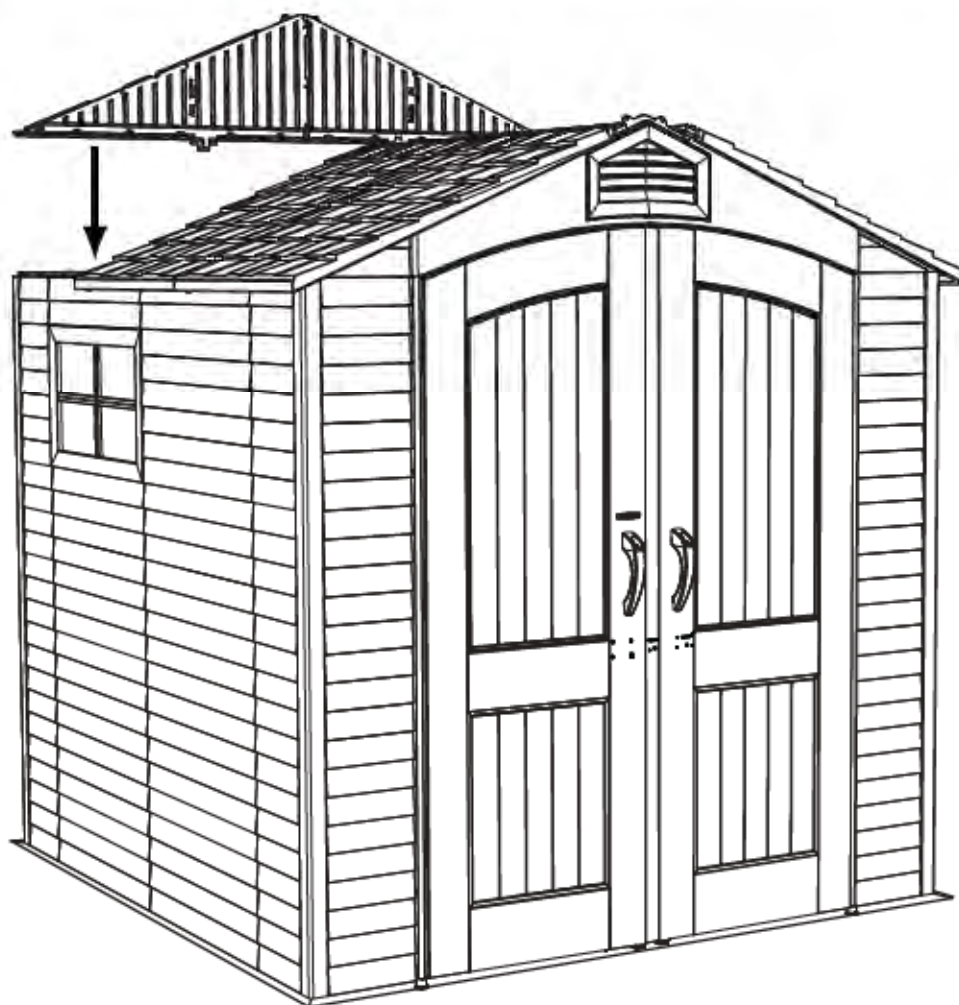



TOOLS AND HARDWARE REQUIRED FOR THIS PAGE

SEC 10

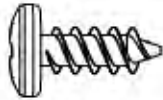

ADZ (x16)

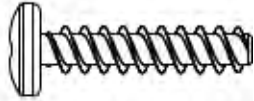

ADV (x8)



BYT (x8)



SEC 10.7

Attach the last two Roof Panels to the Shed. Secure the Rear Gable Assembly and Roof Panels together using eight (8) **Gable-to-Roof Clips (BYT)** (In the direction illustrated), sixteen (16) **1/4" x 5/8" Pan-Head Screws (ADZ)**, and eight (8) **1/4" x 1 1/8" Pan-Head Screws (ADV)**. The Screws (ADV) connect the tops of the Wall Panels to the bottom of the Roof Panels.

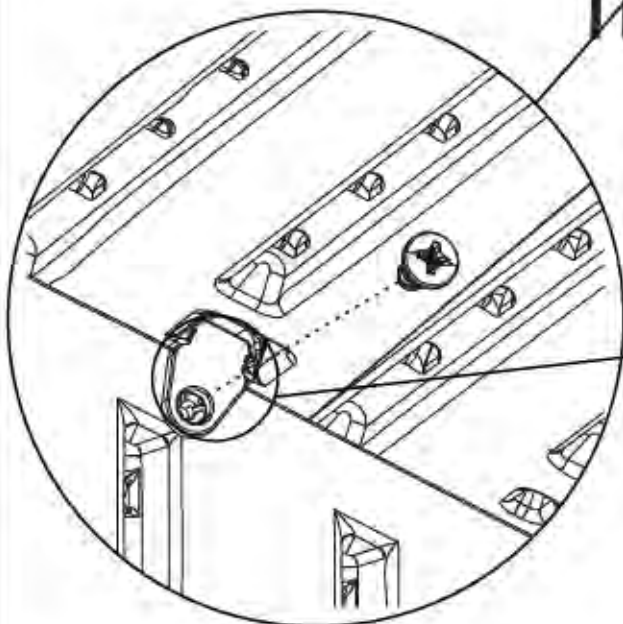
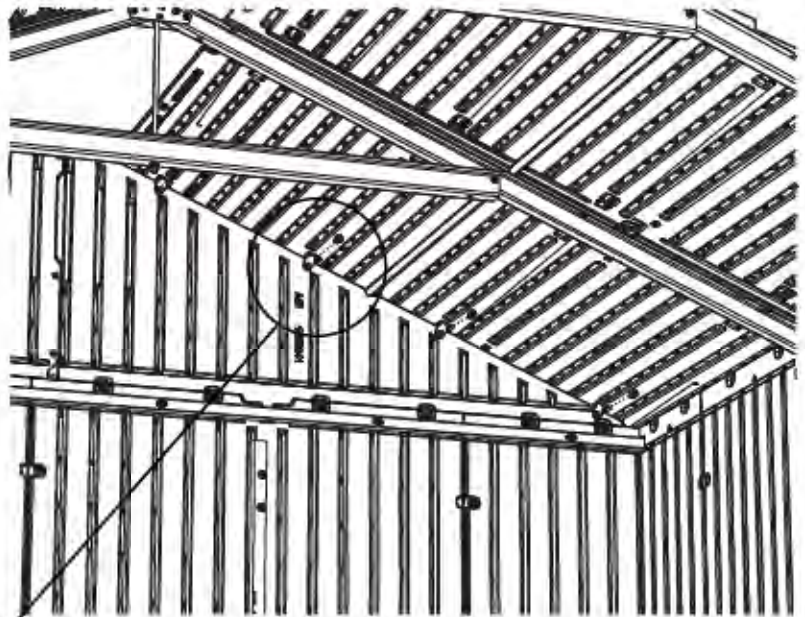

Note: Insert all Gable-to-Roof Clips this direction for the Rear Gable.



TOOLS AND HARDWARE REQUIRED FOR THIS PAGE

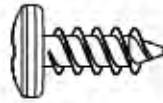

ADZ (x2)

SEC 10



SEC 10.8

Insert two (2) End Roof Cap Filters (BYX) into the slots in an End Roof Cap (BYW) as shown. Repeat this step for the second End Roof Cap.

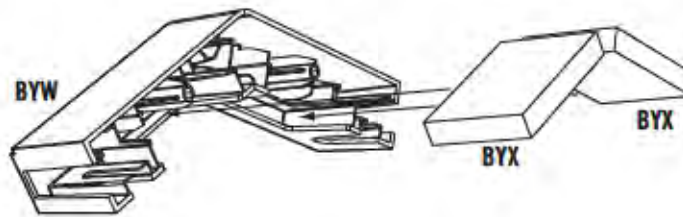

SEC 10.9

Attach the End Roof Cap to the front of the Shed. Secure the End Roof Cap to the two the front Roof Panels using two (2) 1/4" x 5/8" Pan-Head Screws (ADZ).

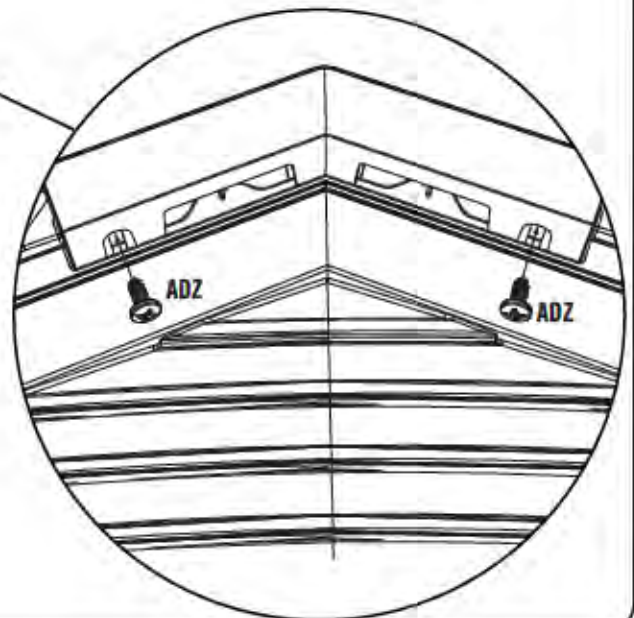
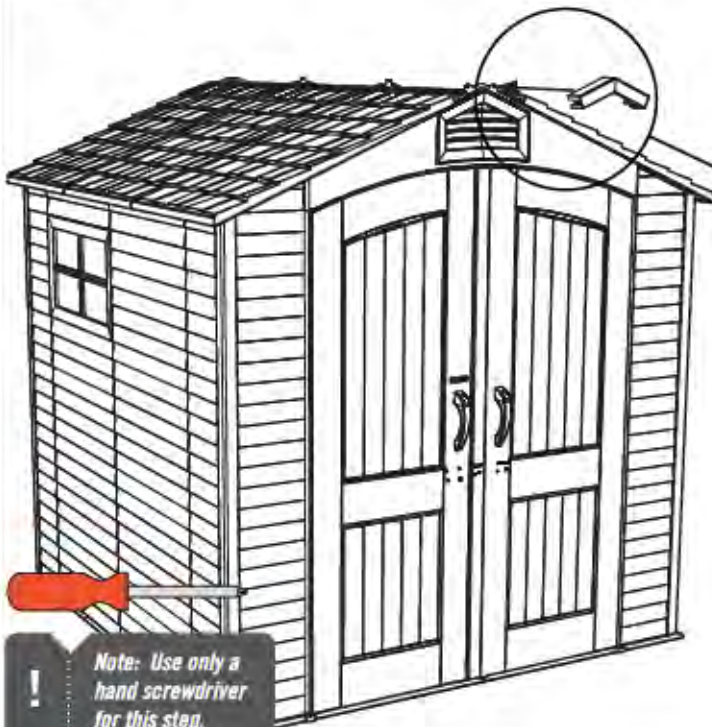

Note: Use only a hand screwdriver for this step.



TOOLS AND HARDWARE REQUIRED FOR THIS PAGE

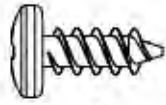

ADZ (x2)

SEC 10



SEC

10.10

Secure the End Roof Cap to the Entry Gable using two (2) 1/4" x 5/8" Pan-Head Screws (ADZ).

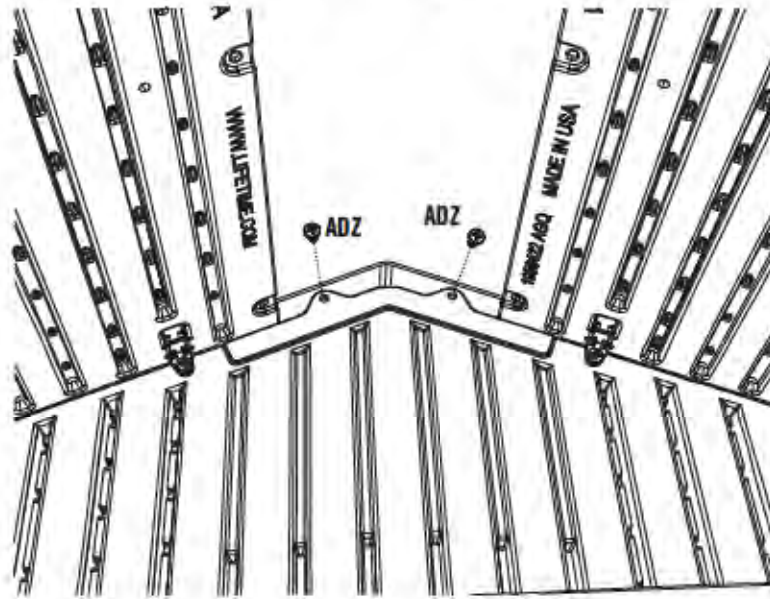

SEC

10.11

Insert the Skylight (BYV) into the End Roof Cap.

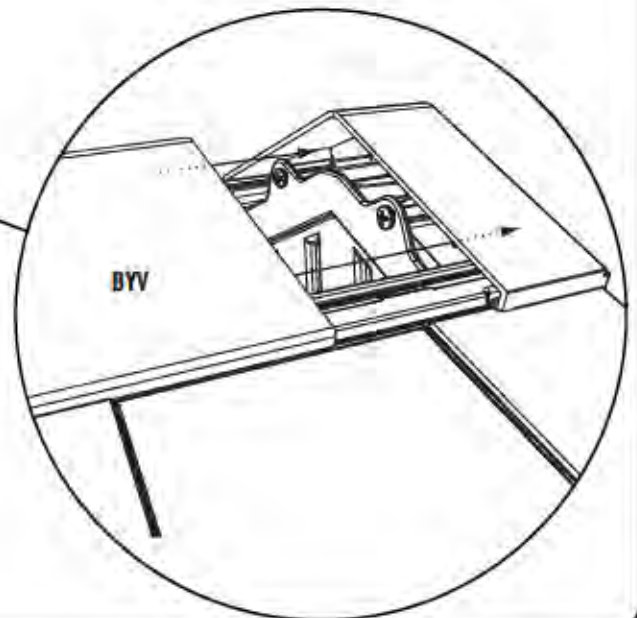
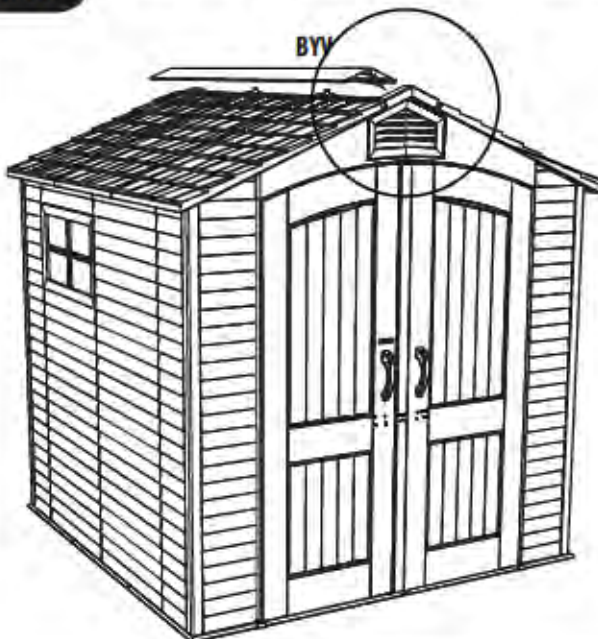



TOOLS AND HARDWARE REQUIRED FOR THIS PAGE

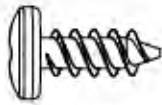
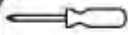

ADZ (x22)

SEC 10



SEC

10.12

Secure the Skylight to the Roof Panels using eighteen (18) 1/4" x 5/8" Pan-Head Screws (ADZ).

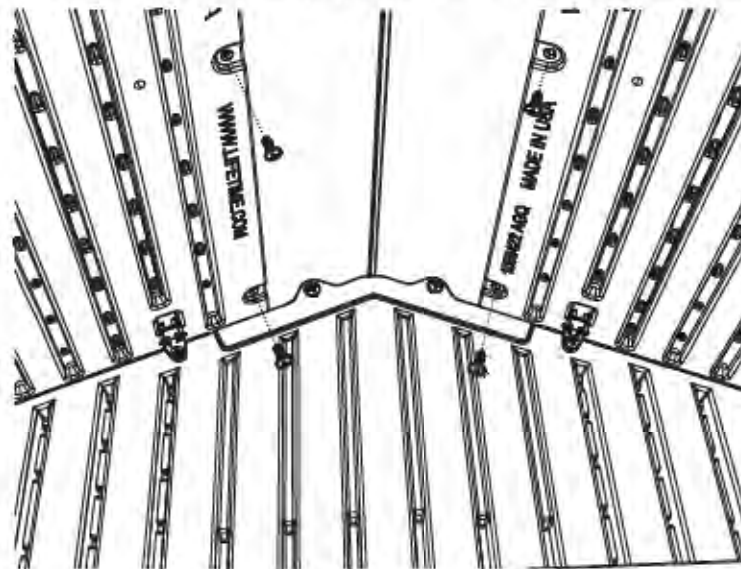

SEC

10.13

Secure the second End Roof Cap (BYW) to the rear of the Shed using four (4) 1/4" x 5/8" Pan-Head Screws (ADZ).

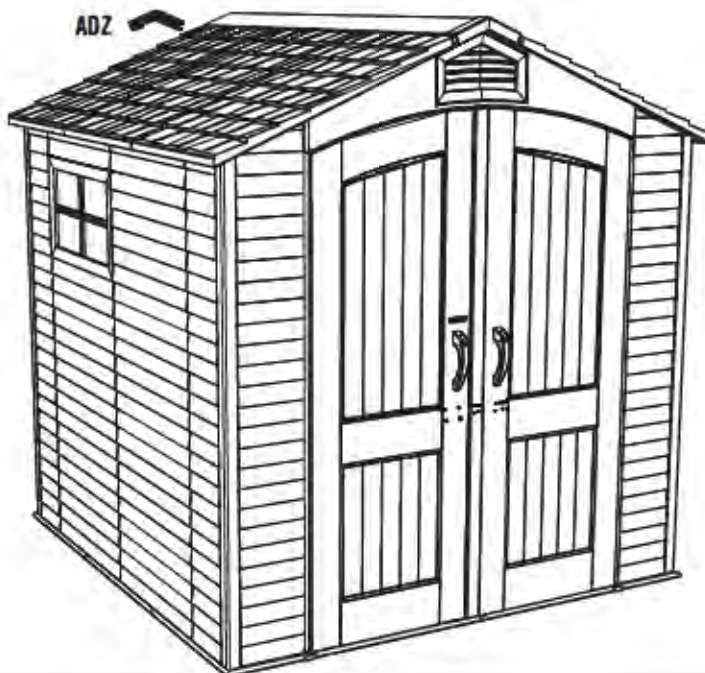

SEC 11 WEATHERPROOFING & DOOR ALIGNMENT

HARDWARE REQUIRED

NO HARDWARE PROVIDED FOR THIS SECTION

TOOLS REQUIRED

SMALL PARTS BOX REQUIRED: BYU

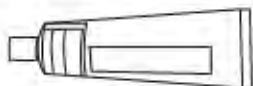

BZC Tube of Caulking (Provided) (x1)



Sheet of Wax Paper



**AIX (x4)
Wood Shim**



Safety Glasses



TOOLS AND HARDWARE REQUIRED FOR THIS PAGE



BZC (x1)



Wax Paper



NO HARDWARE REQUIRED FOR THIS PAGE

SEC 11



SEC

11.1

To help increase the weather resistance of your shed, place a small sheet of wax paper between the ridges and the Window as shown. Tape the sheet of wax paper to the Window, if necessary. Apply a generous 1/4" bead of **Caulking (BZC)** to the ridge at the side of the window opening and against the wax paper as shown. **Repeat for the left side and bottom of the Window.** Let dry. After drying, open the Window and gently remove the wax paper.

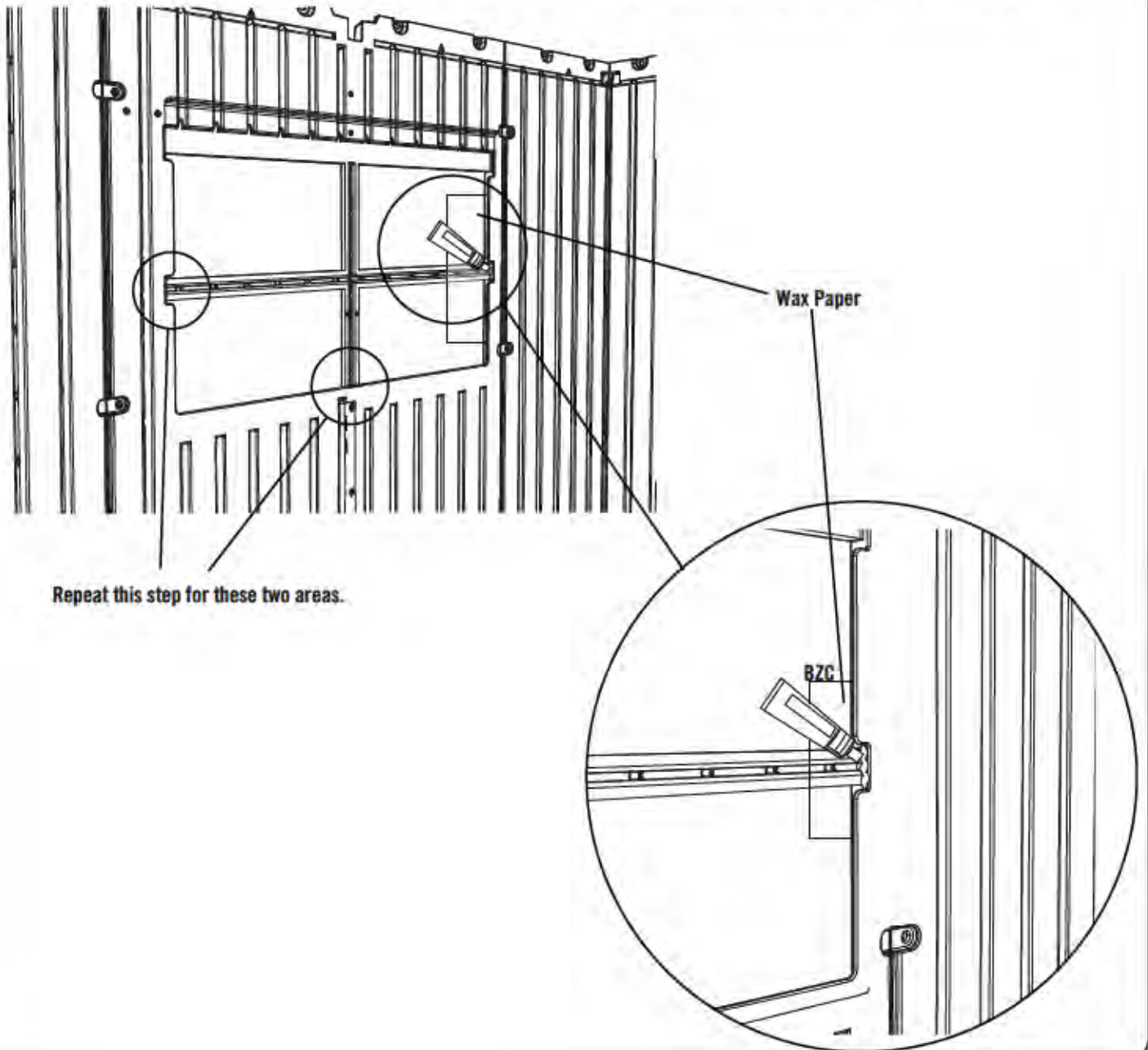



TOOLS AND HARDWARE REQUIRED FOR THIS PAGE

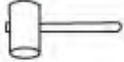

AIX (x4)
Wood Shim

NO HARDWARE PROVIDED FOR THIS PAGE

SEC 11



SEC

11.2

DOOR ALIGNMENT

In some cases, the shed doors may not completely line up at the tops (fig. 1). When this happens, identify which side is higher and use a **Wood Shim (AIX)** to slightly raise the back corner of the high side until doors line up (fig. 2). If doors need further adjustment, insert another shim under the front corner opposite of the first shim. If the doors still need further adjustment, stack additional shims (one at a time) alternating between the back and front shims. After doors are aligned, cut off any portion of wood shim that is still exposed. From inside the shed, drive a 1" nail through the floor into the shim to hold it in place.



Fig. 1

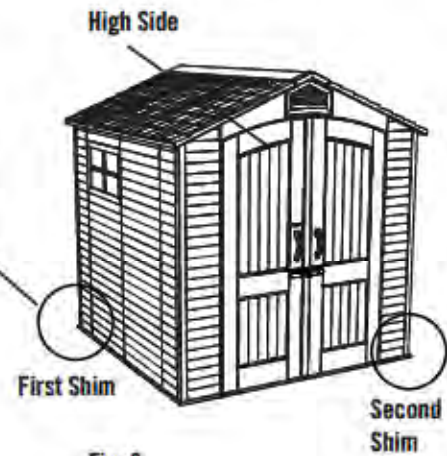
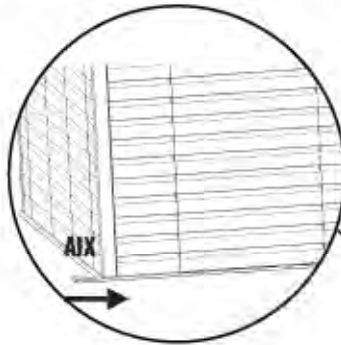

Fig. 2



Note: Shim should be placed at the corner, running directly under one wall.

SEC 12 LATCH INSTALLATION

HARDWARE REQUIRED

HARDWARE BAG REQUIRED: CVP

Hardware shown at actual size

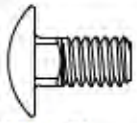

ACA (x3)
1/4" x 1/2" Carriage Bolt

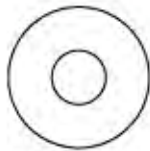

AEB (x3)
1/4" Flat Washer



ADX (x9)
#10 x 1/2" Pan-Head Screw



AAB (x3)
1/4" Centerlock Nut



CHK (x2)
#10 x 3/4" Self-Drilling/Self Tapping Screw



AEE (x9)
#10 Flat Washer

Hardware shown at same scale

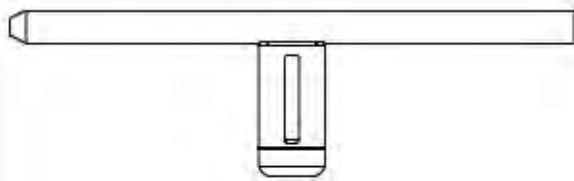

CVW (x1)
Door Latch

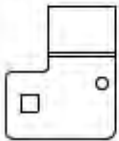

CVT (x1)
Left Door Latch Bracket

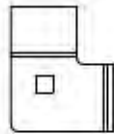

CVU (x1)
Large Right Door Latch Bracket

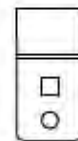

CVV (x1)
Small Right Door Latch Bracket

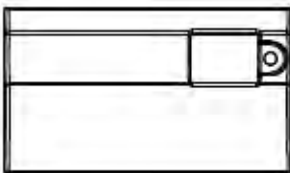

CVS (x1)
Left Door Latch Cover



CVR (x1)
Small Right Door Latch Cover

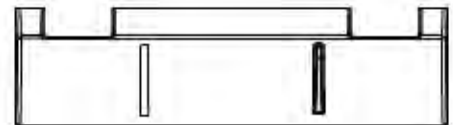

CVQ (x1)
Large Right Door Latch Cover

TOOLS REQUIRED



Phillips Screwdriver



7/16" Wrench



Electric Drill



Safety Glasses



TOOLS AND HARDWARE REQUIRED FOR THIS PAGE

SEC 12



7/16"

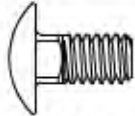

ACA (x1)

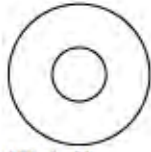

AEB (x1)

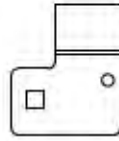

CVT (x1)
(Not to scale)

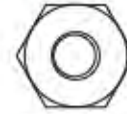

AAB (x1)



ENSURE YOU ALIGN THE DOORS BEFORE PROCEEDING WITH THIS SECTION!

SEC

12.1

LATCH INSTALLATION

Ensure you align the Doors before proceeding with this section. Connect the **Left Door Latch (CVT)** to the Left Door using one (1) 1/4" x 1/2" Carriage Bolt (ACA), one (1) 1/4" Flat Washer (AEB), and one (1) 1/4" Center Lock Nut (AAB). Do not tighten Nut until instructed to do so.

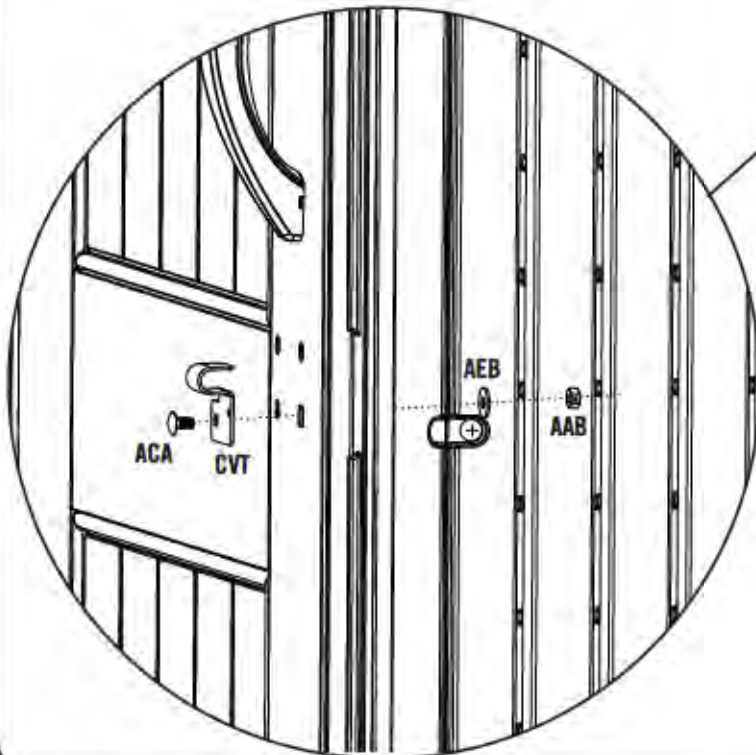
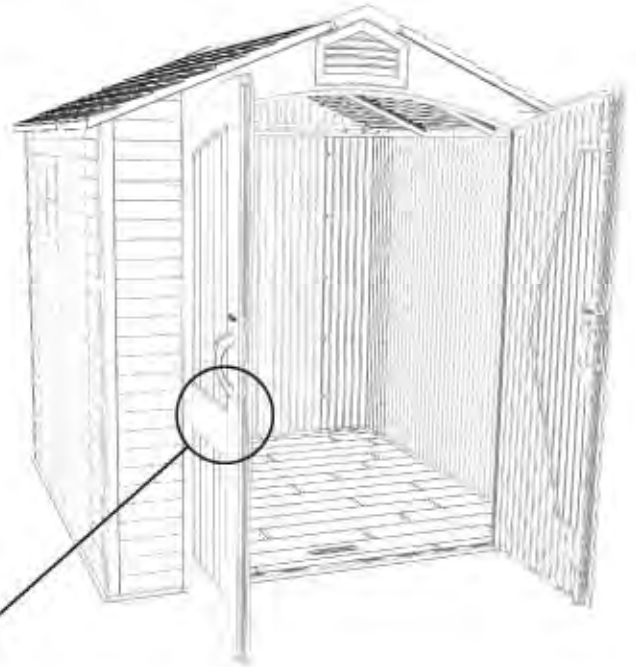



TOOLS AND HARDWARE REQUIRED FOR THIS PAGE

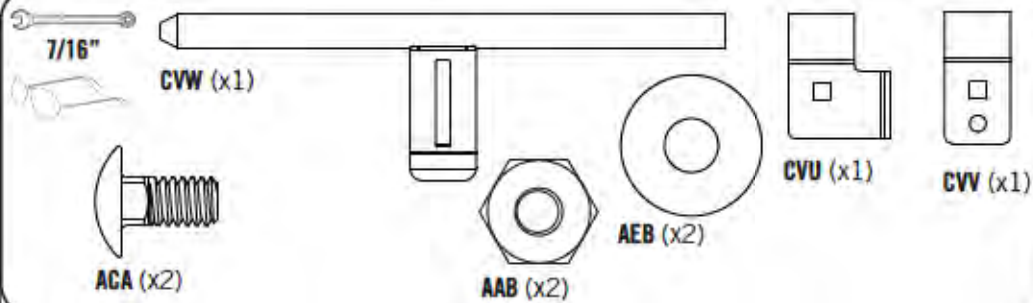

SEC 12

SEC 12.2

Slip the **Door Latch (CVW)** into the loops of the **Large Right Door Latch Bracket (CVU)** and the **Small Right Door Latch Bracket (CVW)** as shown.

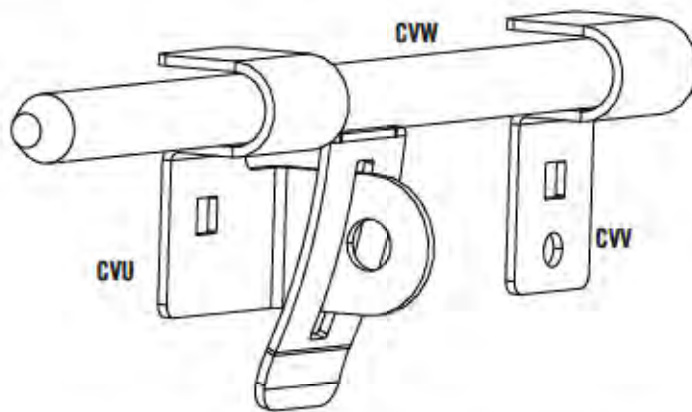

SEC 12.3

Connect the Latch Assembly to the Right Door using two (2) 1/4" x 1/2" Carriage Bolts (ACA), two (2) 1/4" Flat Washers (AEB), and two (2) 1/4" Center Lock Nuts (AAB). Tighten these two Nuts securely, but do not overtighten.

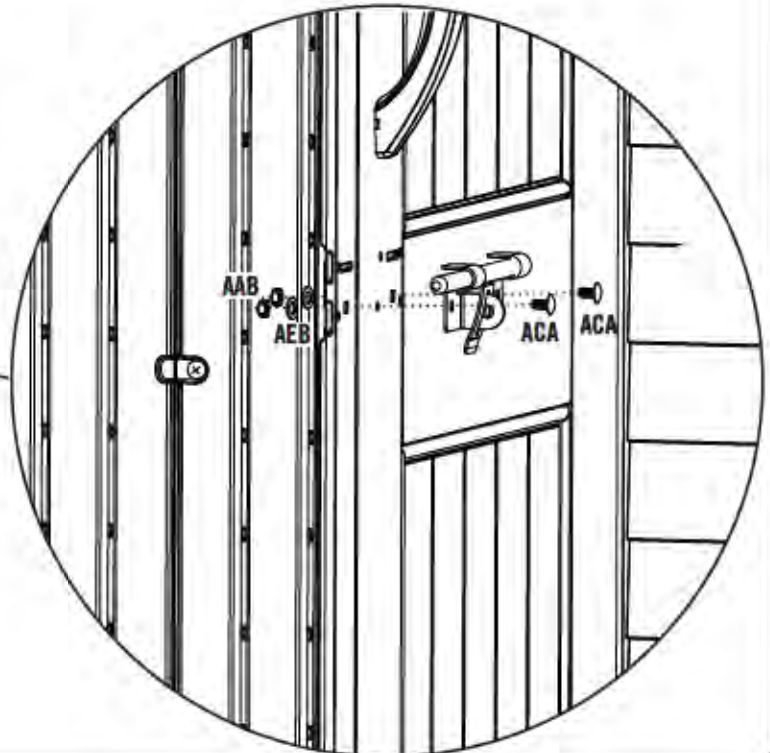



TOOLS AND HARDWARE REQUIRED FOR THIS PAGE

SEC 12

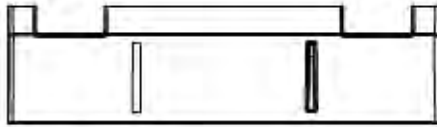

CVQ (x1)

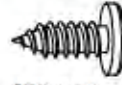

ADX (x3)



AEE (x3)



SEC

12.4

Insert the **Large Right Door Latch Cover (CVQ)** at an angle over the Right Door Latch Brackets as shown. Then, rotate the Cover so it's flat against the Door as shown. Secure the Large Right Door Latch Cover to the Door using three (3) **#10 x 1/2" Pan-Head Screws (ADX)** and three (3) **#10 Flat Washers (AEE)**.

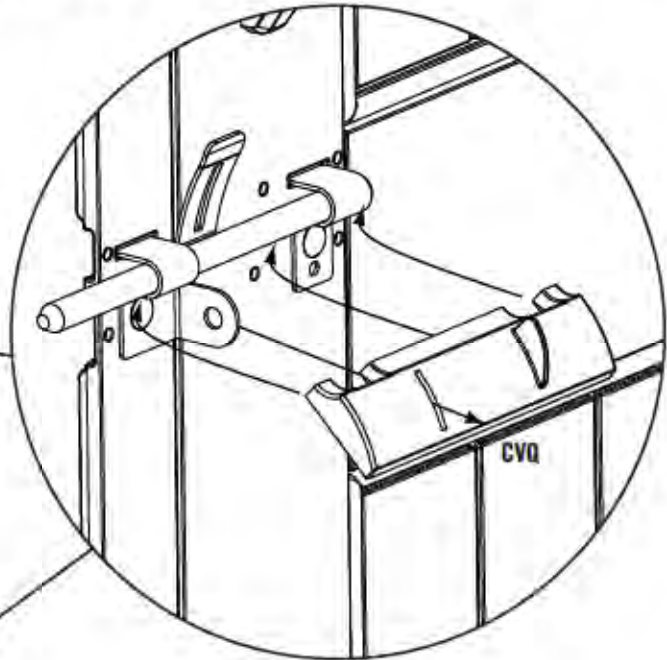

CVQ

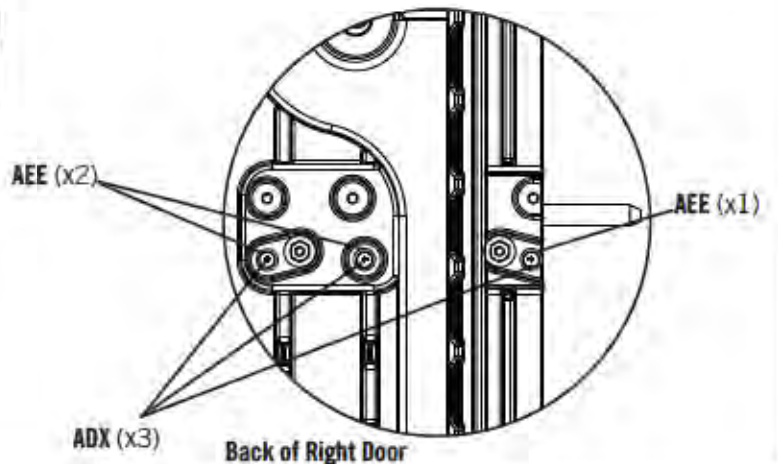
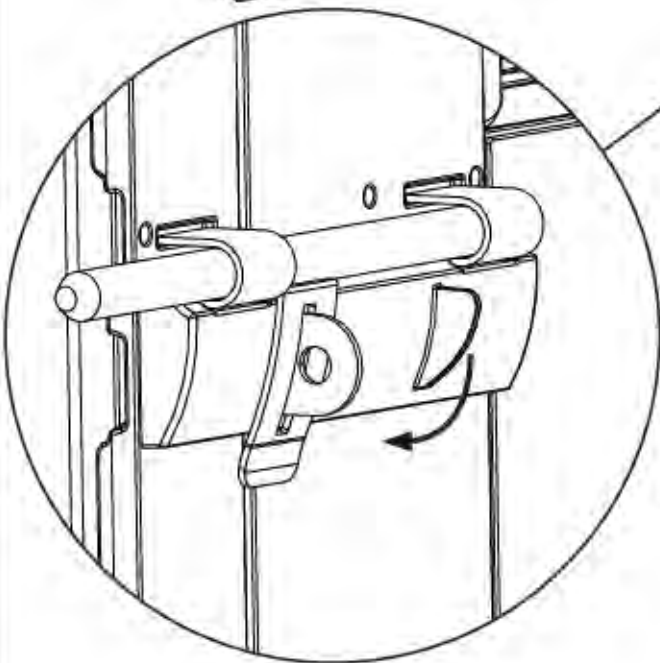

AEE (x2)

AEE (x1)

ADX (x3)

Back of Right Door



TOOLS AND HARDWARE REQUIRED FOR THIS PAGE

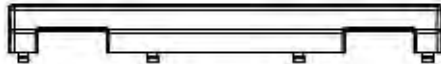
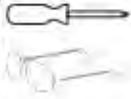

CVR (x1)



AEE (x3)



ADX (x3)



SEC

12.5

Slide the **Small Right Door Latch Cover (CVR)** down over the Right Door Latch Brackets as shown. Secure the Small Right Door Latch Cover to the Door using three (3) #10 x 1/2" Pan-Head Screws (**ADX**) and three (3) #10 Flat Washers (**AEE**).

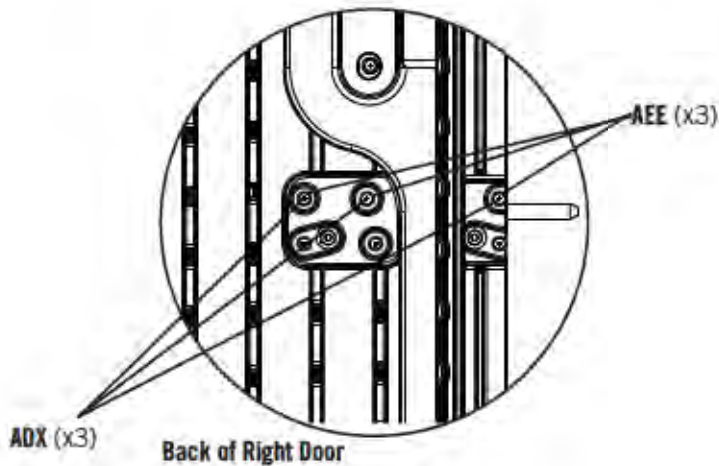
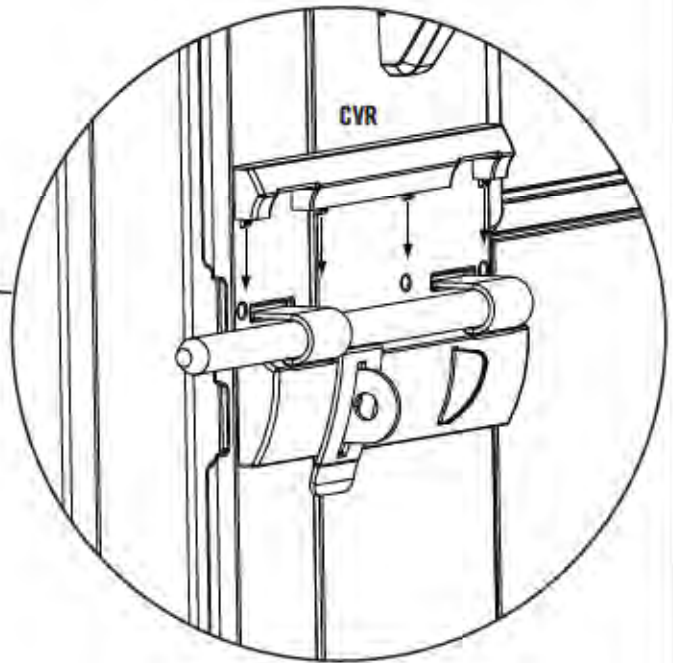
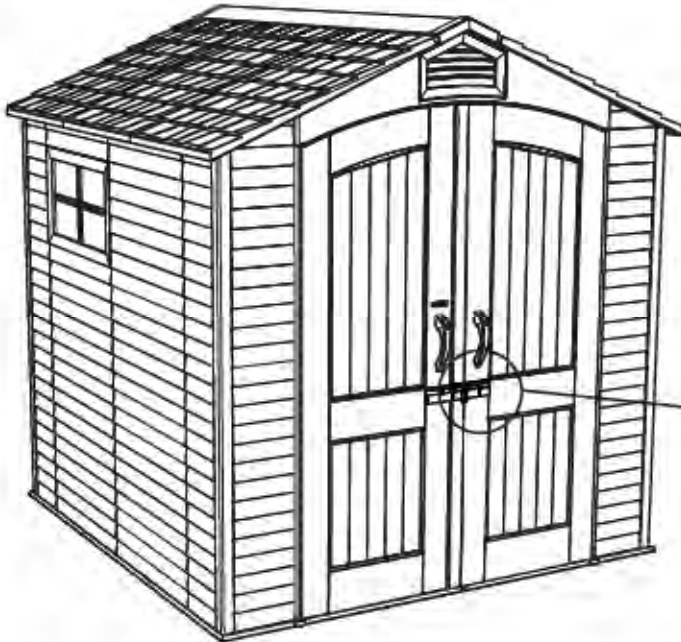



TOOLS AND HARDWARE REQUIRED FOR THIS PAGE

7/16"

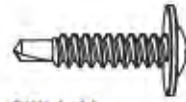

CHK (x1)

SEC 12



SEC

12.6

Close the Doors, and adjust the Left Door Latch Bracket up or down so the Door Latch closes easily. Once the Left Door Latch Bracket is in place, insert one (1) #10 x 3/4" Self-Drilling/Self Tapping Screw (CHK) through the small hole in the Left Door Latch Bracket, through the Left Door, and into the Square Tube inside the Door. **Do not overtighten.** Finally, open the Doors and tighten the **Centerlock Nut (AAB)** on the back of the Left Door.

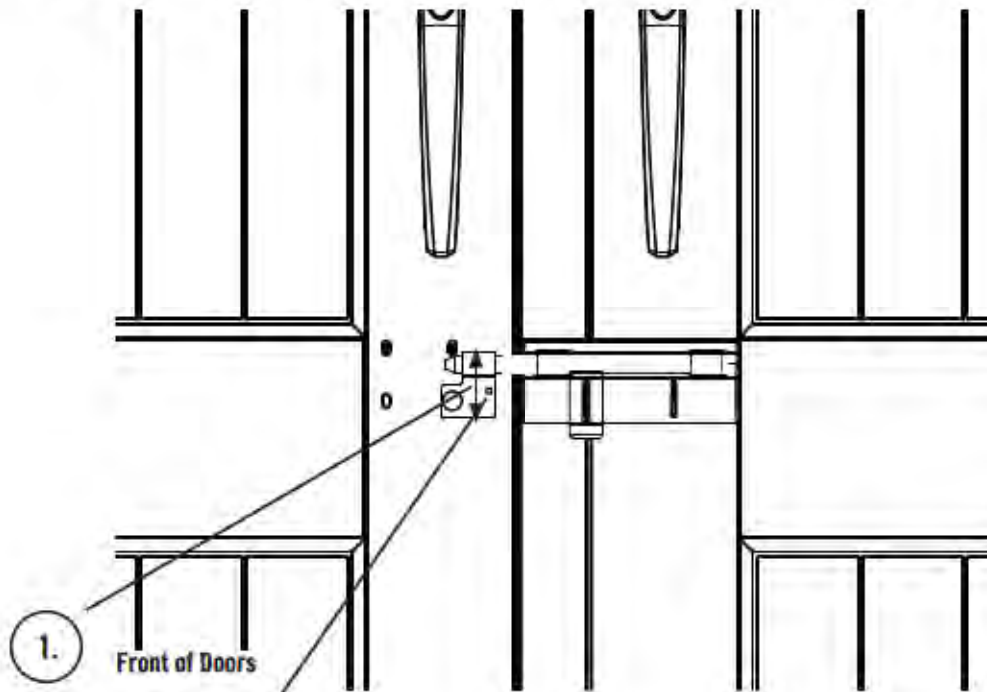

CHK (x1)

2.

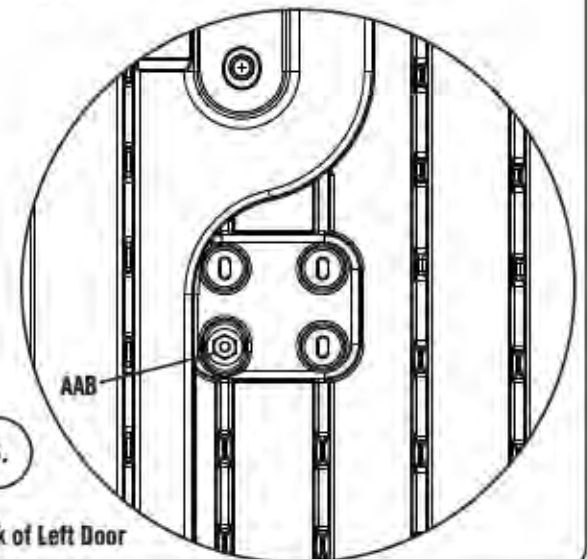

3.
Back of Left Door



TOOLS AND HARDWARE REQUIRED FOR THIS PAGE

SEC 12

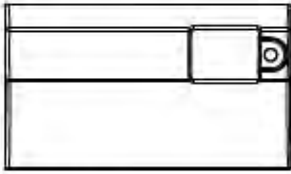
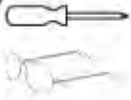

CVS (x1)



ADX (x3)



AEE (x3)



SEC

12.7

Place the **Left Door Latch Cover (CVS)** over the Left Door Latch Bracket as shown. Secure the Left Door Latch Cover to the Door using three (3) **#10 x 1/2" Pan-Head Screws (ADX)** and three (3) **#10 Flat Washers (AEE)**.

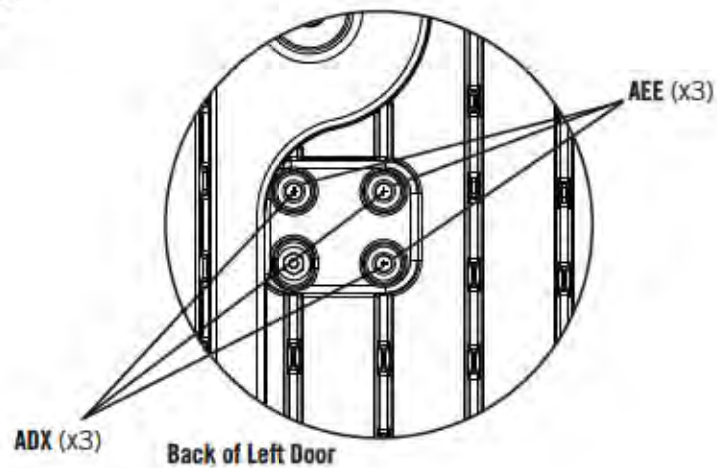

ADX (x3)

Back of Left Door

AEE (x3)



TOOLS AND HARDWARE REQUIRED FOR THIS PAGE

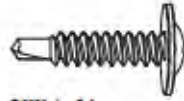

CHK (x1)

SEC 12



SEC

12.8

Using an electric drill, insert one (1) #10 x 3/4" Self-Drilling/Self Tapping Screw (CHK) through the small hole in the Left Door Latch Cover, through the Left Door, and into the Square Tube inside the Door. **Do not overtighten.**

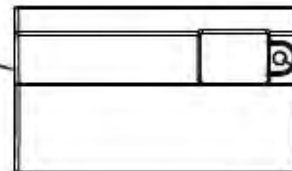
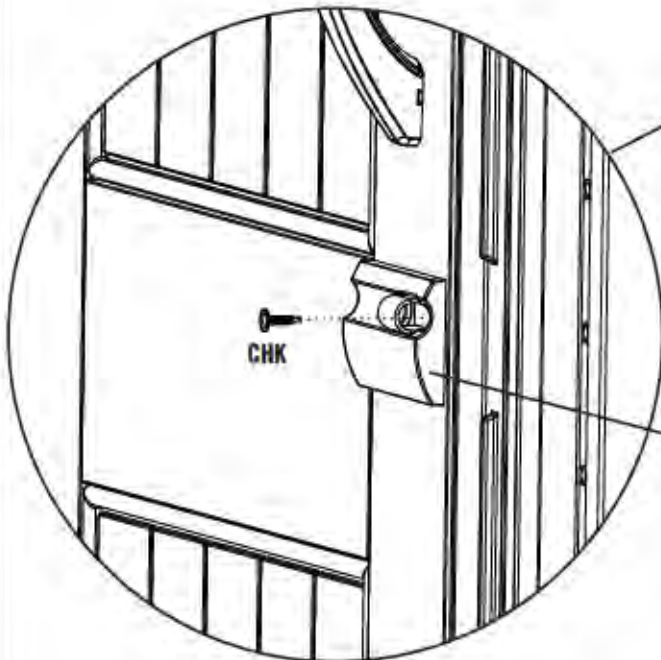

Insert the Screw (CHK) through this hole.

CLEANING & CARE

Congratulations on your Lifetime® product purchase. By following the instructions below, your new Lifetime product should provide you with years of service and enjoyment.

Cleaning and Care

The polyethylene panels are stain- and solvent-resistant. Most stains can be removed, using a mild soap and a soft-bristled brush. Abrasive cleaning materials may scratch the plastic and are not recommended. Repair scratches or rust spots on the metal by sanding the affected area lightly; using a rust preventative spray primer; and finally, spraying with a high-gloss spray enamel paint. Avoid placing a direct heat source on or near surfaces unless using a heat barrier.

LIFETIME OUTDOOR SHED EQUIPMENT

10-YEAR LIMITED FACTORY WARRANTY

THE MANUFACTURER RESERVES THE RIGHT TO MAKE SUBSTITUTIONS TO WARRANTY CLAIMS IF PARTS ARE UNAVAILABLE OR OBSOLETE.

1. Lifetime outdoor sheds are warranted to the original purchaser to be free from defects in material or workmanship for a period of ten years from the date of original retail purchase. The word "defects" is defined as imperfections that impair the use of the product. Defects resulting from misuse, abuse or negligence will void this warranty. This warranty does not cover defects due to improper installation, alteration or accident. This warranty does not cover damage caused by vandalism, rusting, "acts of nature" or any other event beyond the control of the manufacturer.
2. This warranty is nontransferable and is expressly limited to the repair or replacement of defective product. If the product is defective within the terms of this warranty, Lifetime Products, Inc. will repair or replace defective parts at no cost to the purchaser. Shipping charges to and from the factory or distribution center are not covered and are the responsibility of the purchaser. Labor charges and related expenses for removal, installation or replacement of the shed or its components are not covered under this warranty.
3. This warranty does not cover scratching or scuffing of the product that may result from normal usage. In addition, defects resulting from intentional damage, negligence, unreasonable use or hanging from the truss will void this warranty.
4. Liability for incidental or consequential damages is excluded to the extent permitted by law. While every attempt is made to embody the highest degree of safety in all equipment, freedom from injury cannot be guaranteed. The user assumes all risk of injury resulting from the use of this product. All merchandise is sold on this condition, and no representative of the company may waive or change this policy.
5. This product is not intended for institutional or commercial use; Lifetime Products, Inc. does not assume any liability for such use. Institutional or commercial use will void the warranty.
6. This warranty is expressly in lieu of all other warranties, expressed or implied, including warranties of merchantability or fitness for use to extent permitted by Federal and state law. Neither Lifetime Products, Inc., nor any representative assumes any other liability in connection with this product. This warranty gives you specific legal rights, and you may also have other rights which vary from state to state.

PLEASE INCLUDE YOUR DATED SALES RECEIPT AND PHOTOGRAPHS OF DAMAGED PARTS.

REPORT PRODUCT DEFECTS IN WRITING TO:

Lifetime Products, Inc., PO Box 160010 Clearfield, UT 84016-0010
or call 1-800-225-3865 M-F 7 a.m. to 5 p.m. MST.

REGISTER YOUR PRODUCT FOR QUICKER CUSTOMER SERVICE.

Visit www.lifetime.com or call 1-800-225-3865 to register your product today.

FOR INTERNATIONAL WARRANTY CLAIMS:

All warranty claims must be accompanied by a sales receipt. Report all warranty claims in writing to your regional sales support representative. Please include your dated sales receipt and photographs of damaged parts. To identify the representative for your region — Please visit: www.lifetime.com/international



www.lifetime.com

ENHANCE YOUR LIFETIME® PURCHASE BY ADDING ACCESSORIES OR OTHER GREAT PRODUCTS:

To purchase accessories or other Lifetime Products, visit us at:

www.lifetime.com

Or call: 1-800-424-3865

