



ASSEMBLY INSTRUCTIONS

Pour le français, voir la page 2. 
Para el español, ver la página 3.

15' x 8' OUTDOOR STORAGE SHED

Lifetime® sheds are designed to be strong and durable. We strive to make assembly as easy as possible without compromising quality. If you get stuck, we have tools to help:

- **Build a Foundation**
Construct a level surface before you start (see page 6 for instructions).
- **Recruit Friends and Family**
Assembly should take 3 people about 4–6 hours to complete.



TOOLS REQUIRED



TABLE OF CONTENTS

Icon Legend.....	4
Warnings & Notices.....	5
Platform Construction.....	6
Truss Assembly.....	11
Gable Assembly.....	19
Door Assembly.....	23
Skylight Assembly.....	32
Floor Assembly.....	36
Wall Assembly.....	40
Shelving Installation.....	47
Parts Identifier.....	49
Roof Assembly.....	55
Shutter Installation.....	78
Window Installation.....	81
Pegboard Installation.....	84
Tool Corral Installation.....	87
Door Alignment.....	89
Anchoring.....	91
Cleaning & Care.....	95
Registration.....	96
Warranty.....	97

NEED HELP? TALK TO US!

Lifetime's assembly experts offer quick responses and great customer service.

Call: 1-800-225-3865
7:00 am–5:00 pm (Monday–Friday) MST
and 9:00 am–1:00 pm Saturday MST

Web: www.lifetime.com/instructions
Live Chat: www.lifetime.com/instructions

MODEL# AND PRODUCT ID (you will need both when contacting us)
Model Number: 60079 Product ID:

LIFETIME

INSTRUCTIONS D'ASSEMBLAGE

For English, see page 1.

Para el español, ver la página 3.



ABRI EXTÉRIEUR DE 4,57 m x 2,44 m

Les abris Lifetime® sont conçus pour être solides et durables. Nous nous efforçons de rendre l'assemblage aussi facile que possible sans compromettre la qualité. Si vous êtes coincé, nous avons les outils nécessaires pour vous aider :

• Construisez une Plate-forme

Construisez une plate-forme nivelée avant de commencer.

(voyez la page 6 pour les instructions)

• Rassemblez vos Amis et votre Famille

L'assemblage par 3 adultes devrait prendre à peu près 4 – 6 heures.



OUTILS REQUIS

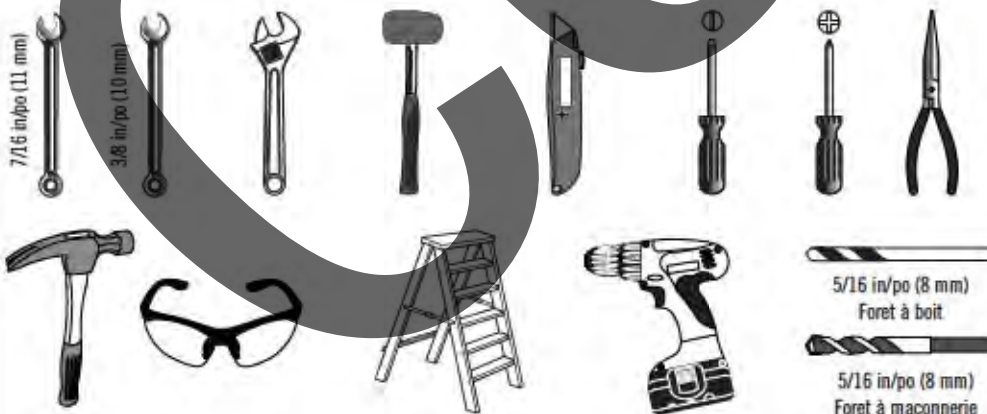

SOMMAIRE

Légende des icônes.....	4
Avertissements et avis.....	5
Assemblage de la plate-forme.....	6
Assemblage des fermes.....	11
Assemblage des pignons.....	19
Assemblage des portes.....	23
Assemblage des lucarnes.....	32
Assemblage du plancher.....	36
Assemblage des murs.....	40
Installation du rayonnage.....	47
Identificateur des pièces.....	49
Assemblage du toit.....	55
Installation des volets.....	78
Installation des carreaux.....	81
Installation de l'organiseur.....	84
Installation du corral.....	87
Alignement des portes.....	89
L'ancrage de l'abri.....	91
Nettoyage et entretien.....	95
Enregistrement.....	96
Garantie.....	98

NÉCESSITEZ-VOUS DE L'AIDE ? COMMUNIQUEZ-NOUS !

Composer le 1-800-225-3865

Du lundi au vendredi 7 h – 17 h (HNR)
et samedi 9 h – 13 h (HNR)

web: www.lifetime.com/instructions

tchat: www.lifetime.com/instructions

Nos experts d'assemblage Lifetime® offrent des réponses rapides et un service à la clientèle supérieure.

MODÈLE ET RÉFÉRENCE DU PRODUIT (vous aurez besoin des deux lorsque vous nous contactez)

Numéro de modèle : Référence du produit :

60079

For English, see page 1.

Pour le français, voir la page 2.



CASETA EXTERIOR DE 4,57 m x 2,44 m

Las casetas Lifetime® son diseñadas para ser sólidas y durables. Nos esforzamos por hacer el ensamble lo más fácil posible sin comprometer la calidad. Si se atasque, tenemos las herramientas necesarias para ayudarle:

- **Construya una plataforma**
Construya una plataforma nivelada antes de comenzar.
(vea la página 6 para las instrucciones)
- **Reuna a sus amigos y a su familia**
El ensamble debe realizarse de 3 adultos y unas 4-6 horas.



INSTRUMENTAL REQUERIDO



Broca para madera de 8 mm
Broca de albañilería de 8 mm

ÍNDICE

Leyenda de iconos.....	4
Advertencias y avisos.....	5
Ensamble de la plataforma.....	6
Ensamble de las cerchas.....	11
Ensamble de las fachadas.....	19
Ensamble de las puertas.....	23
Ensamble de los tragaluces.....	32
Ensamble del piso.....	36
Ensamble de los muros.....	40
Instalación de la estantería.....	47
Identificador de piezas.....	49
Ensamble del tejado.....	55
Instalación de contraventanas.....	78
Instalación de las hojas de ventana.....	81
Instalación de organizadores.....	84
Instalación del corral.....	87
Alineación de las puertas.....	89
Anclaje de la caseta.....	91
Limpieza y cuidado.....	95
Registro.....	96
Garantía.....	99

¿NECESITA AYUDA? ¡LLÁMENOS!

Los expertos de ensamble Lifetime® ofrecen respuestas rápidas y servicio valorado.

Llame al **1.800.225.3865**

De lunes hasta viernes 7:00 hr-17:00 hr (HNR)
y sábado 9:00 hr-13:00 hr (HNR)

Web: www.lifetime.com/instructions

Live Chat: www.lifetime.com/instructions

MODELO E ID DEL PRODUCTO (necesitará los dos al contactarnos)

Número de modelo: **ID del producto:**
60079



ICON LEGEND / LÉGENDE DES ICÔNES / LEYENDA DE ÍCONOS



- Indicates special heed should be taken when reading.
- Indique qu'une attention spéciale doit être prise lors de la lecture.
- Indica que uno debe prestar atención al leer.



- Indicates the parts to be used for a section.
- Indique les pièces à utiliser pour une section.
- Indica las piezas que se usarán en una sección.



- Indicates no parts required for a specific section.
- Indique qu'aucune pièce n'est requise pour une section précise.
- Indica que no se necesitan partes en una sección específica.



- Indicates the hardware to be used for a section.
- Indique la quincaillerie à utiliser pour une section.
- Indica el herraje que se usará en una sección.



- Indicates no hardware required for a specific page.
- Indique qu'aucun matériel n'est requis pour une page précise.
- Indica que no se necesita herraje en una página específica.



- Indicates the tools to be used for a section.
- Indique les outils à utiliser pour une section.
- Indica el instrumental que se usará en una sección.



- Indicates to use/not to use an electric drill for a specific step.
- Indique quand utiliser ou ne pas utiliser une perceuse électrique pour une étape précise.
- Indica usar o no usar un taladro eléctrico en un paso específico.



WARNINGS & NOTICES / AVERTISSEMENTS ET AVIS / ADVERTENCIAS Y AVISOS

English:

- **Failure to follow these warnings may result in serious injury or property damage and will void warranty.**
- To ensure safety, do not attempt to assemble this product without following the instructions carefully.
- Consult all local building codes to verify if the shed requires a building permit.
- Verify the foundation is completely level before assembling the shed.
- Be aware that plastic pieces can be damaged by overtightening the screws. To avoid damage, we strongly recommend the use of a drill with a low torque setting. A #2 Phillips screwdriver may also be used.
- Three capable adults are required for assembly.
- All who participate in the assembly process should wear safety glasses throughout the assembly.
- If using a ladder during assembly, use extreme caution.
- In heavy snowfall areas, we recommend removing snow from the roof.
- Do not use or store hot objects near the product.
- Proper and complete assembly are essential to reduce the risk of accident or injury.
- We strongly recommend anchoring your shed when it is finished. The last section, Shed Anchoring, in this manual shows the hardware you'll need to complete the anchoring. You can find the hardware at your local hardware store.
- **Most injuries are caused by misuse and/or not following instructions. Use caution when using this product.**

Le français :

- **Un manquement de suivre ces avertissements peut entraîner des blessures graves ou des dommages à la propriété et annulera la garantie.**
- Afin d'assurer la sécurité, ne pas tenter d'assembler ce produit sans suivre les instructions avec attention.
- Consultez tous les codes du bâtiment afin de vérifier si l'abri nécessite un permis de bâtiment.
- Vérifiez que la fondation soit complètement à niveau avant l'assemblage de l'abri.
- Soyez conscient que les pièces de plastique peuvent être endommagées en serrant trop les vis. Afin d'éviter les dommages, nous recommandons fortement l'utilisation d'une perceuse à faible couple. Une tournevis cruciforme n° 2 peut aussi être utilisé.
- Trois adultes en bonne condition physique sont nécessaires pour l'assemblage.
- Tout ceux qui participent au processus de l'assemblage doivent porter des lunettes de sécurité tout au long de l'assemblage.
- Si vous utilisez une échelle pour l'assemblage, soyez extrêmement prudent.
- Dans les zones de grandes tombées de neige, nous recommandons d'enlever celle-ci du toit.
- Ne pas utiliser ou entreposer d'objet très chaud près de ce produit.
- Une bon assemblage complet est nécessaire pour réduire le risque d'accident ou de blessure.
- Nous recommandons fortement d'ancrer votre remise lorsque l'assemblage est terminé. La dernière section, Ancrage de la remise, de ce manuel démontre les matériaux nécessaires afin de compléter l'ancrage. Vous pouvez trouver les matériaux dans votre quincaillerie locale.
- **La majorité des blessures sont causées par une mauvaise utilisation et/ou le non suivi des instructions. Soyez prudent lorsque vous utilisez ce produit.**

El español:

- **No seguir estas advertencias puede resultar en lesiones graves o daños a la propiedad y anulará la garantía.**
- A fin de garantizar la seguridad, no intente ensamblar este producto sin seguir cuidadosamente las instrucciones.
- Consulte todos los códigos de construcción locales para verificar si la caseta requiere un permiso de construcción.
- Verifique que el concreto esté nivelado completamente antes de ensamblar la caseta.
- Tenga en cuenta que las piezas de plástico pueden dañarse si los tornillos se aprietan de más. A fin de evitar daños, lo exhortamos a que use un taladro con función de torque bajo. También puede usarse un desatornillador Phillips #2.
- Se necesitan tres adultos aptos para el ensamble.
- Todos los que participen en el proceso de ensamble debe usar anteojos de seguridad durante todo el ensamble.
- Si usa una escalera durante el ensamblado, extreme precauciones.
- En áreas de nevadas fuertes, recomendamos retirar la nieve del techo.
- No use ni guarde objetos calientes cerca del producto.
- El ensamble correcto y completo son esenciales para reducir el riesgo de accidente o lesión.
- Lo exhortamos a anclar su caseta cuando esté terminado. La última sección, Anclaje de la caseta, en este manual muestra el herraje que necesita para terminar el anclaje. Puede encontrar el herraje en su ferretería local.
- **La mayoría de las lesiones suceden a causa del mal uso y/o por no seguir las instrucciones. Tenga precaución al usar este producto.**

PLATFORM CONSTRUCTION / CONSTRUCTION DE LA PLATE-FORME / CONSTRUCCIÓN DE LA PLATAFORMA



• You must provide a platform on which to assemble your shed. Proper building permit documentation may be required in your neighborhood. Consult all local building codes prior to assembling the shed. Before beginning assembly, you must pour or construct a platform. There are two types:

- Concrete
- Wood Frame

Select the type, but know the surface must be leveled before installation. If the surface is not properly leveled, the shed will not assemble correctly. Proper surface leveling will save you time in the long run, so please do not ignore this step. **We recommend a Concrete platform. It will be the most durable and long-lasting choice. The platform you choose must be built above ground in order to avoid water pooling inside the shed. All lumber must be rated for outdoor use!**



• Il faut construire une plate-forme sur laquelle vous devez assembler votre abri. Il est possible que votre quartier exige une documentation visant les permis de construire. Consultez tous les codes du bâtiment locaux, ainsi que les décrets des villes et comtés, pour vérifier que la construction de l'abri extérieur n'exige pas un permis de construire. Avant de commencer le montage, il faut couler ou construire une plate-forme. Il y a deux styles :

- Béton
- Cadre à bois

Sélectionnez le style, mais sachez que la surface d'installation doit être de niveau. Si la surface n'est pas correctement de niveau, l'assemblage de l'abri ne se fera pas correctement. Vous gagnerez du temps sur le long terme grâce à une surface bien de niveau, ne négligez donc pas cette étape. **Nous recommandons une plate-forme en béton. Ce choix sera le plus durable. La plate-forme que vous choisissez doit être construite au-dessus du sol afin d'éviter l'accumulation d'eau à l'intérieur de l'abri. Tous le bois d'oeuvre doit être approuvé pour l'usage à l'extérieur !**



• Es preciso construir una plataforma sobre la cual usted debe ensamblar su caseta. Puede suceder que en su vecindario se requiera la documentación apropiada de un permiso de construcción. Consulte todos los códigos locales de construcción y los reglamentos de la ciudad y el municipio para asegurarse de que la construcción de la caseta no requiere un permiso de construcción. Antes de comenzar el armado, es necesario verter o construir una plataforma. Hay dos clases:

- Concreto
- Armazón de madera

Seleccione la clase, mas sepa que la superficie debe estar nivelada antes de comenzar el ensamble. Si la superficie no está nivelada de manera adecuada, la caseta no podrá armarse correctamente. La nivelación de la superficie le ahorrará tiempo de trabajo, por lo tanto, le pedimos que no ignore este paso. **Recomendamos una plataforma hecho de concreto. Será la elección más perdurable. La plataforma debe ser construida arriba del suelo para evitar el aflujo de agua dentro de la caseta. ¡Toda la madera debe estar clasificada para el uso externo!**



► SECTION 1 (CONTINUED) / SECTION 1 (SUITE) / SECCIÓN 1 (CONTINUACIÓN)

CONCRETE REQUIRED / BÉTON REQUIS / CONCRETO REQUERIDO



2 yd³ (1,53 m³)

1.1

CONCRETE PLATFORM / PLATE-FORME EN BÉTON / PLATAFORMA DE CONCRETO

- The concrete should be approximately 4" (10,2 cm) thick. The actual dimensions of the shed, at its widest and longest points, are 180" x 96" (4,57 m x 2,44 m). Ensure you select a site that will accommodate these measurements. **The floor dimensions are a bit smaller than those of the roof; therefore, you will need to build a level surface of 178" x 93 1/2" (4,52 m x 2,38 m).**
- Le béton doit être un épaisseur de 10,2 cm (4 po). Les dimensions réelles de votre abri, aux points les plus large et long, sont 4,57 m x 2,44 m (178 po x 96 po). Assurez-vous de sélectionner un site qui accommodera ces dimensions. **Les dimensions du plancher de votre abri sont plus petites que le toit; ensuite, il faut créer une surface horizontale de 4,52 m x 2,38 m (178 po x 93 1/2 po).**
- El concreto debe tener, por lo menos, 10,2 cm (4 in) de espesor. Las dimensiones reales de la caseta, a sus puntos más ancho y largo, son 4,57 m x 2,44 m (180 in x 96 in). Asegúrese de seleccionar un sitio que acomodará estas medidas. **Las dimensiones del piso de la caseta son más pequeñas que el tejado; entonces, necesitará crear una superficie nivel de 5,42 m x 2,38 (178 in x 93 1/2 in).**

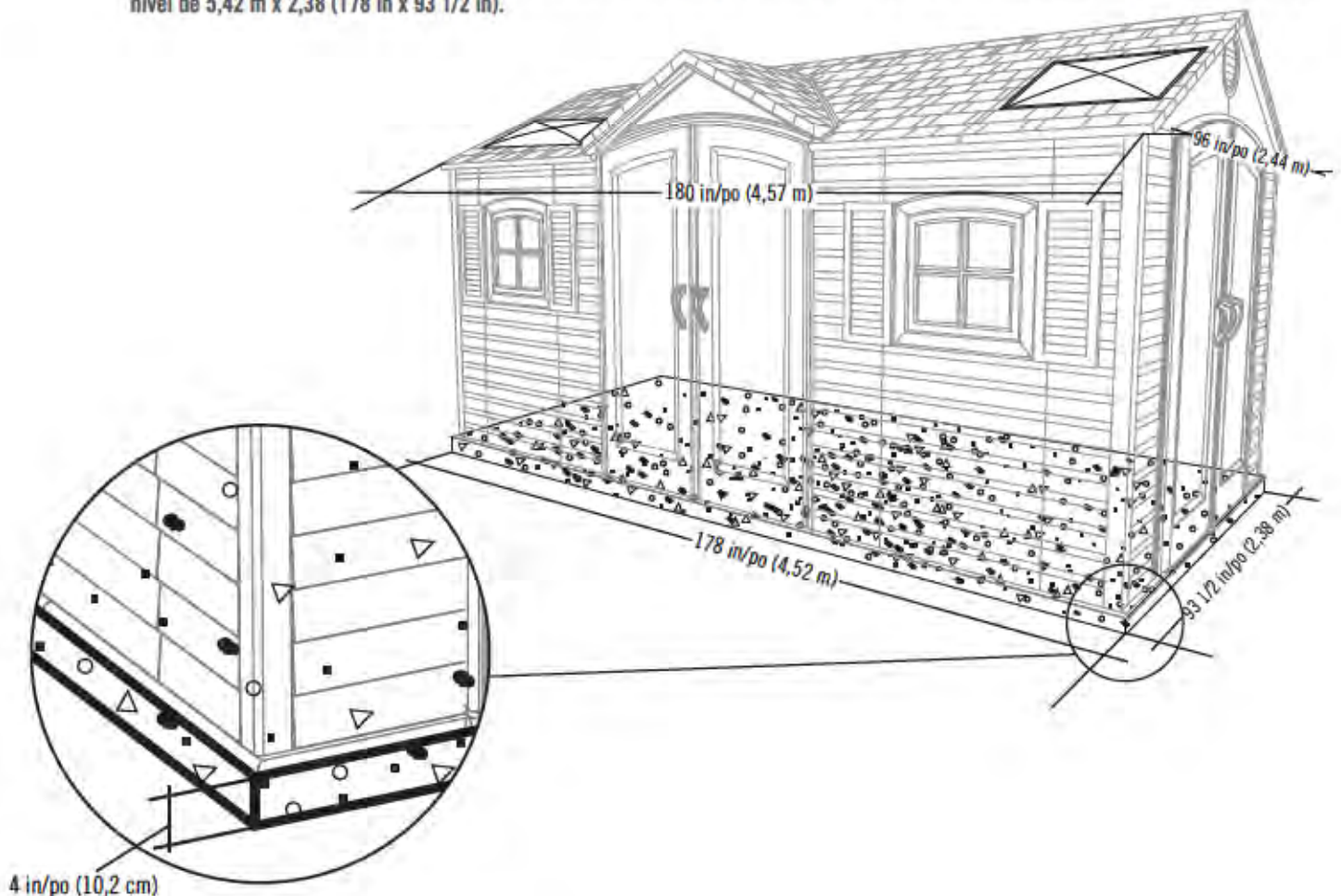

► SECTION 1 (CONTINUED) / SECTION 1 (SUITE) / SECCIÓN 1 (CONTINUACIÓN)

WOOD REQUIRED / BOIS REQUIS / MADERA REQUERIDA



1.2

WOOD PLATFORM / PLATE-FORME EN BOIS / PLATAFORMA DE MADERA

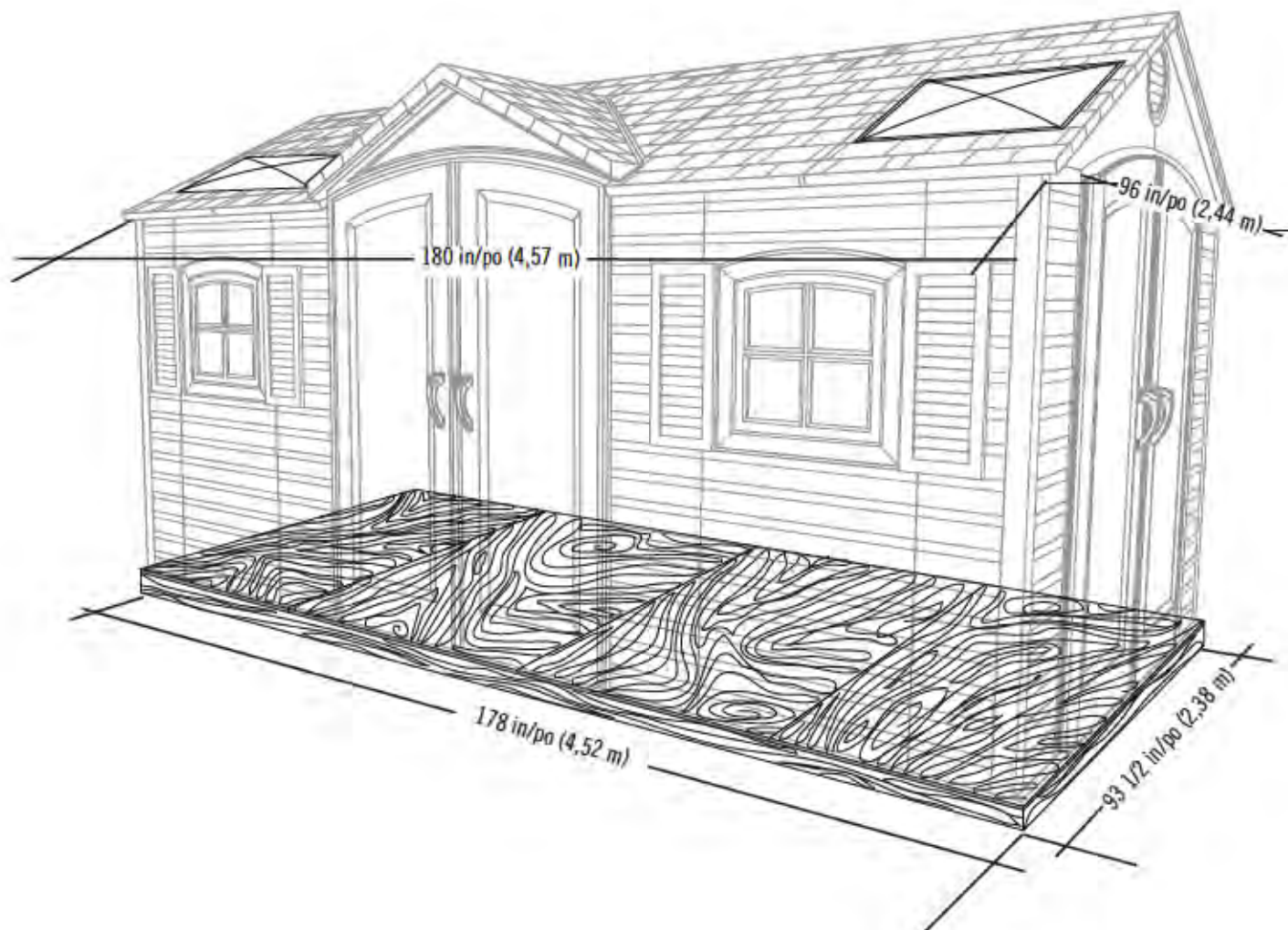

▶ SECTION 1 (CONTINUED) / SECTION 1 (SUITE) / SECCIÓN 1 (CONTINUACIÓN)

WOOD REQUIRED / BOIS REQUIS / MADERA REQUERIDA



2 in/po x 4 in/po x 178 in/po (5,1 cm x 10,2 cm x 4,52 m) (x2)



2 in/po x 4 in/po x 90 1/2 in/po (5,1 cm x 10,2 cm x 2,30 m) (x13)



16d 3 in/po (16d x 7,62 cm) (x52)

1.2.1

- Ensure all lumber is treated and approved for outdoor use. Build frame to 178" x 93 1/2" (4,52 m x 2,38 m) (**outside dimensions**).
- Vérifiez que votre bois d'œuvre a été traité et approuvé pour l'utilisation à l'extérieur. Construisez un cadre de 4,52 m x 2,38 m (178 po x 93 1/2 po) (**dimensions extérieures**).
- Asegure que use madera tratada y aprobada para el uso externo. Construya el armazón a 4,52 m x 2,38 m (178 po x 93 1/2 po) (**dimensiones exteriores**).



x8

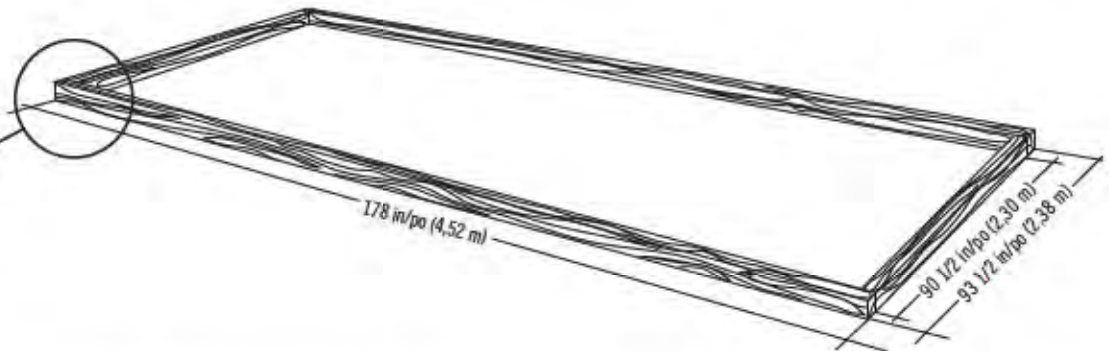

1.2.2

- To ensure studs are in the correct location for nailing plywood in the next step, start measuring from the corner 16" (40,1 cm), and then measure from center to center.
- Pour être sûr d'avoir assez de montant pour clouer le contreplaqué dans la prochaine étape, commencez à mesurer à partir de cette montant 40,1 cm (16 po) vers le centre du deuxième montant. Ensuite, mesurez de centre à centre pour les montants restants.
- Para asegurarse que los montantes están en las ubicaciones correctas para el contrachapado en el paso siguiente, comience a medir desde el borde del montante hasta el centro del próximo montante 40,1 cm (16 in). Luego, tome la medida de centro a centro en los montantes restantes.



x44

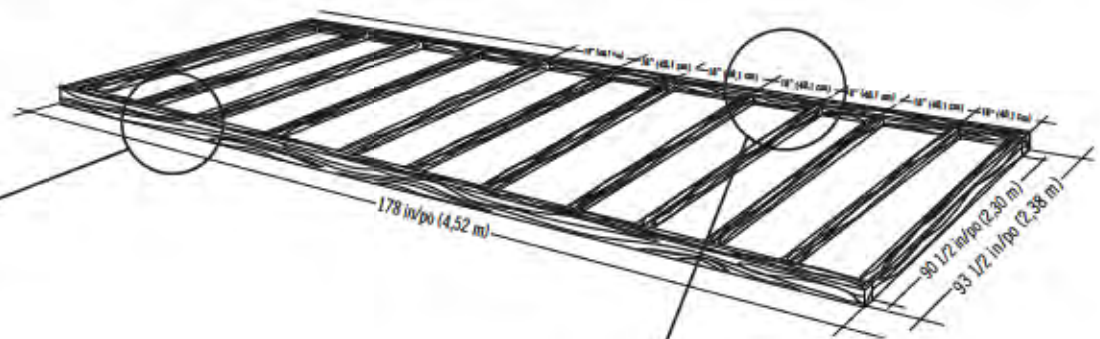
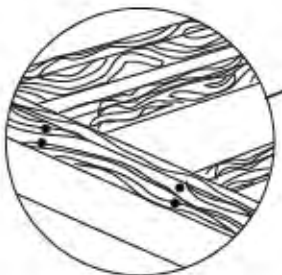

▶ SECTION 1 (CONTINUED) / SECTION 1 (SUITE) / SECCIÓN 1 (CONTINUACIÓN)

WOOD REQUIRED / BOIS REQUIS / MADERA REQUERIDA



3/8 in/po (10 mm)



48 in/po x 93 1/2 in/po x 3/4 in/po
(1,22 m x 2,38 m x 19,1 mm) (x3)



34 in/po x 93 1/2 in/po x 3/4 in/po
(86,4 cm x 2,38 m x 19,1 mm) (x1)



8d 1 1/2 in/po (8d 3,81 cm) (x72)

1.2.3

- Square the frame measuring from corner to corner.
- Carrez le cadre en mesurant d'angle à angle.
- Cuadre el armazón midiendo de esquina a esquina.

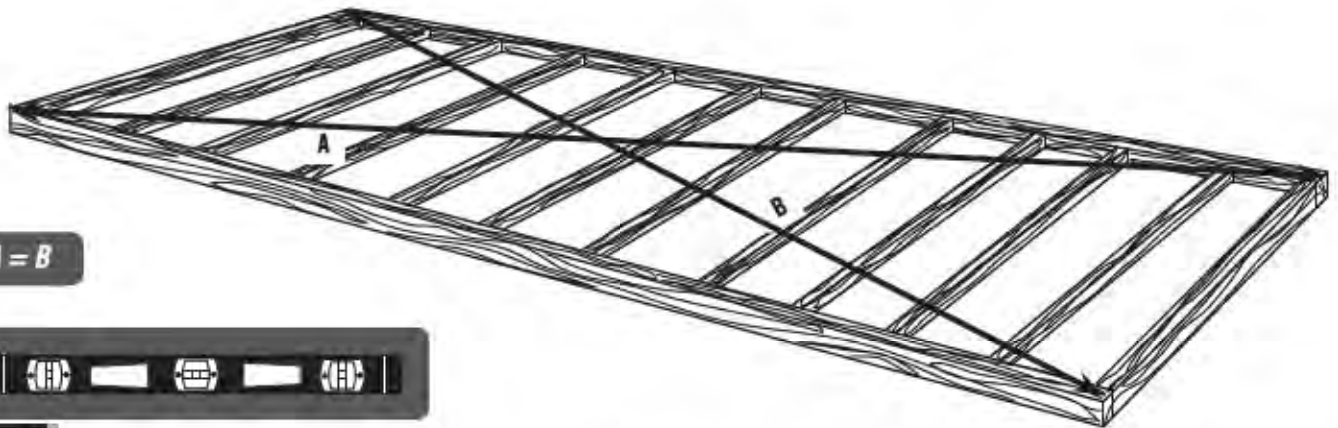

A = B

1.2.4

- Using nails, fasten the plywood to the frame. Then, drill holes for drainage.
- En utilisant des clous, attachez bien le contreplaqué au cadre. Ensuite, percez des trous de drainage.
- Usando unos clavos, sujete el contrachapado al armazón. Entonces, taladre agujeros para el drenaje.



x72

48 in/po x 93 1/2 in/po x 3/4 in/po
(1,22 cm x 2,38 m x 19,1 mm)

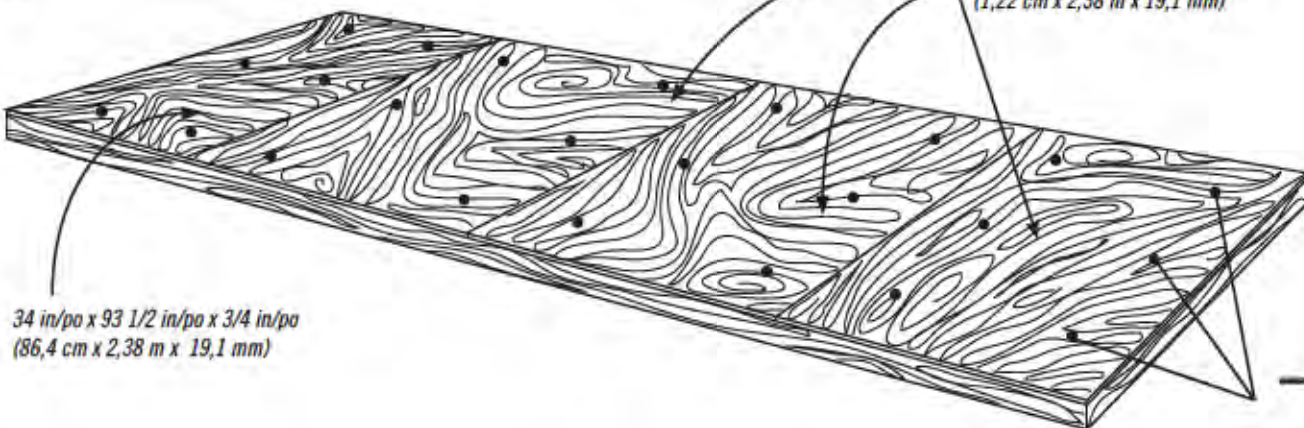

34 in/po x 93 1/2 in/po x 3/4 in/po
(86,4 cm x 2,38 m x 19,1 mm)

- Drainage Holes
- Agujeros para canalización
- Trous de drainage

x24!

2

TRUSS ASSEMBLY / ASSEMBLAGE DES FERMES / ENSAMBLE DE LAS CERCHAS



HARDWARE REQUIRED / QUINCAILLERIE REQUISE / HERRAJE REQUERIDO

Hardware Bag / Sac de quincaillerie / Bolsa de herraje



DTK (x22)



AHT (x1)



ADJ (10)

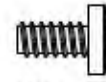

ADY (x19)



CXK (x2)



DTJ (x1)



ADK (x40)



11 9/16 in/po (29,4 cm)

ADH (x5)



PARTS REQUIRED / PIÈCES REQUISES / PIEZAS REQUERIDAS

Metal Parts / Pièces en métal / Piezas de metal



58 1/4 in/po (1,47 m)

DSP (x1)



50 9/16 in/po (1,28 m)

DSQ (x2)



50 9/16 in/po (1,28 m)

DSR (x7)



34 1/8 in/po (86,7 cm)

DSO (x1)

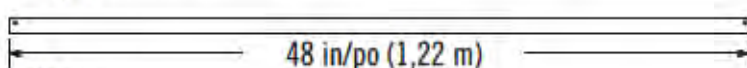

48 in/po (1,22 m)

AFG (x5)



AIP (x5)



1-8 7/16 in/po (21,4 cm)-1

DSN (x1)



25 7/8 in/po (65,7 cm)

DSM (x1)



TOOLS REQUIRED / OUTILS REQUIS / INSTRUMENTAL REQUERIDO

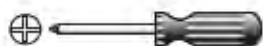

7/16 in/po (11 mm) (x2)

3/8 in/po (10 mm) (x2)

► SECTION 2 (CONTINUED) / SECTION 2 (SUITE) / SECCIÓN 2 (CONTINUACIÓN)

TOOLS AND HARDWARE REQUIRED / OUTILS ET QUINCAILLERIE REQUIS / INSTRUMENTAL Y HERRAJE REQUERIDOS



3/8 in/pc (x2)
(10 mm) (x2)



ADK (x8)

2.1

SIDE TRUSSES (x2) / FERMES LATÉRALES (x2) / CERCHAS LATERALES (x2)

- Attach a **Connector (AIP)** to the end of two **Truss Gutter Channels (DSQ & DSR)** as shown.
- Attachez un **raccord (AIP)** à l'extrémité des **canaux de gouttière (DSQ et DSR)** comme illustré.
- Sujete un **connector (AIP)** a los extremos de los **canalones de la cercha (DSQ y DSR)** como se muestra.

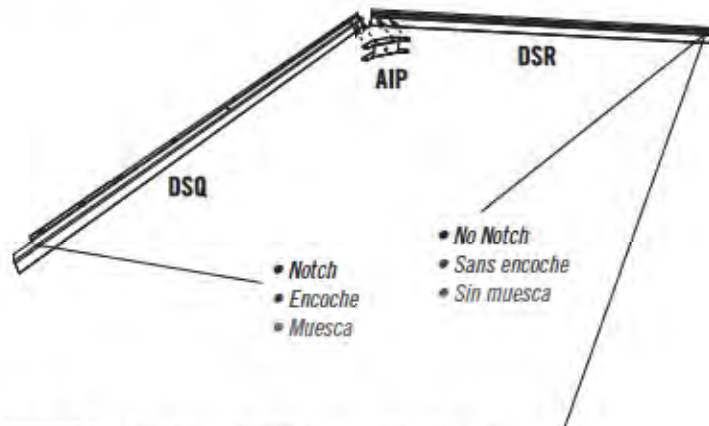

- **Note:** Channel (DSR) has no notch at the end.
- **Remarque :** Le canal (DSR) n'a pas d'encoche à l'extrémité.
- **Nota:** El canalón (DSR) no tiene una muesca al extremo.

2.2

- Attach a **Connector (AIP)** to the end of the **Truss Gutter Channels (DSQ & DSR)** as shown.
- Attachez un **raccord (AIP)** à l'extrémité des **canaux de gouttière (DSQ et DSR)** comme illustré.
- Sujete un **connector (AIP)** a los extremos de los **canalones de la cercha (DSQ y DSR)** como se muestra.

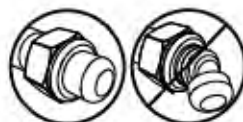
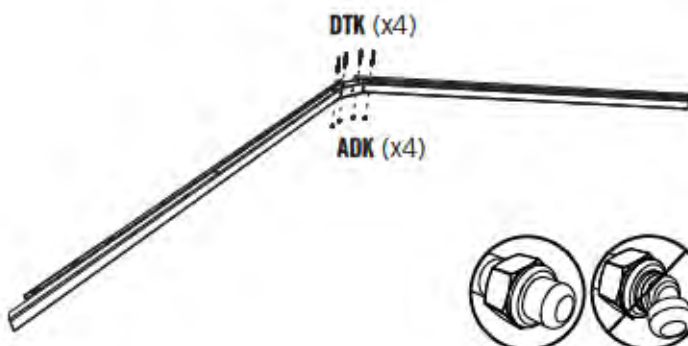

2.3

- Slide a **Truss Brace (AFG)** onto the Truss Gutter Channels as shown.
- Glissez un **support de la ferme (AFG)** sur les canaux de gouttière comme illustré.
- Deslice un **soporte de la cercha (AFG)** sobre los canalones de la cercha como se muestra.

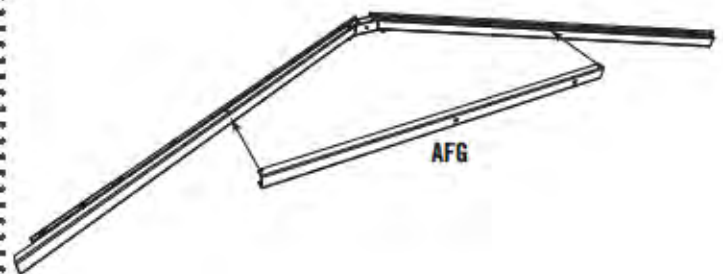

► SECTION 2 (CONTINUED) / SECTION 2 (SUITE) / SECCIÓN 2 (CONTINUACIÓN)

TOOLS AND HARDWARE REQUIRED / OUTILS ET QUINCAILLERIE REQUIS / INSTRUMENTAL Y HERRAJE REQUERIDOS



3/8 in/po
(10 mm)



7/16 in/po (x2)
(11 mm) (x2)

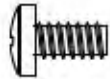

ADY (x8)



ADK (x8)



ADJ (x4)

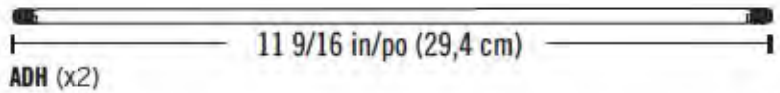

2.4

- Attach the Truss Brace using the hardware provided. **Do not overtighten.**
- Attachez le support de la ferme à l'aide de la quincaillerie incluse. **Ne serrez pas excessivement.**
- Sujete el soporte de la cercha usando el herraje indicado. **No apriete demasiado.**

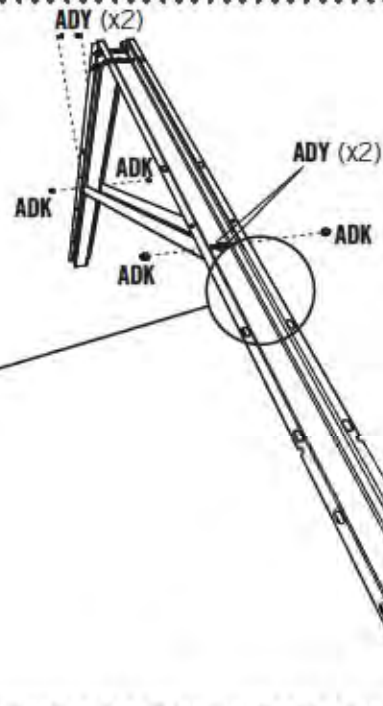
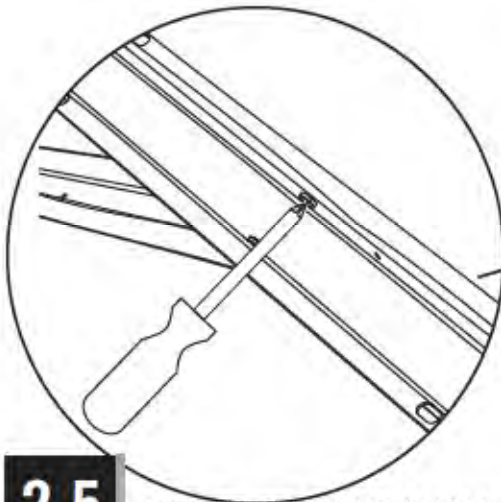

2.5

- Slide a Truss Rod (ADH) through the holes in the Brace and Connector. Secure with two Cap Nuts (ADJ). Repeat the previous steps for a second Side Truss.
- Glissez une tige (ADH) à travers les trous dans le support et le raccord. Attachez-le bien à l'aide de deux écrous à chape (ADJ). Répétez les étapes précédentes pour une deuxième ferme latérale.
- Deslice una varilla (ADH) a través de los agujeros en el Soporte y el conector. Sujétela con dos tuercas ciegas (ADJ). Repita los pasos anteriores para una segunda cercha lateral.

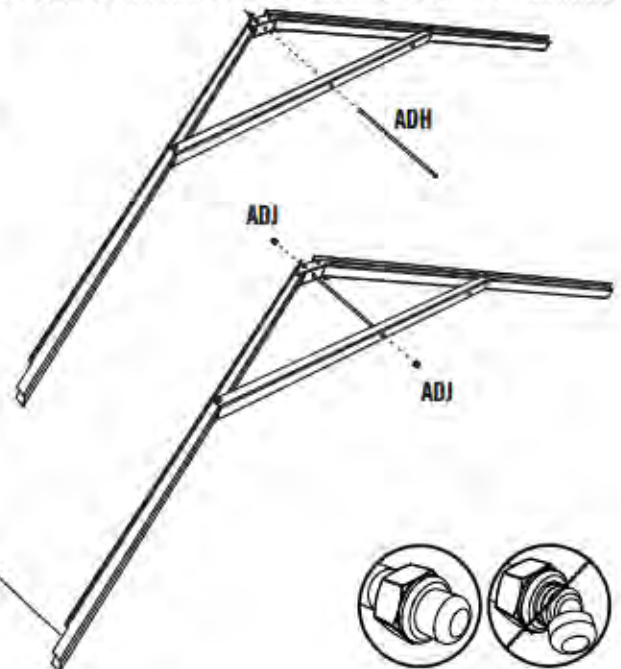

- **Note:** This notched end will face the front of the shed.
- **Remarque :** Cette extrémité encochée fera face à la partie avant de l'abri.
- **Nota:** Este extremo muescado dará a la parte delantera de la caseta.

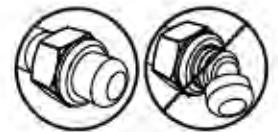

SECTION 2 (CONTINUED) / SECTION 2 (SUITE) / SECCIÓN 2 (CONTINUACIÓN)

TOOLS AND HARDWARE REQUIRED / OUTILS ET QUINCAILLERIE REQUIS / INSTRUMENTAL Y HERRAJE REQUERIDOS



7/16 in/po (x2)
(11 mm) (x2)



3/8 in/po (x2)
(10 mm) (x2)



ADJ (x4)



DTK (x8)

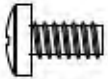

ADY (x8)



ADK (x16)



ADH (x2)

11 9/16 in/po (29,4 cm)

2.6



- Repeat the previous steps for two Truss Assemblies without notches on both ends.
- Répétez les étapes précédentes pour assembler deux fermes sans les encoches aux deux extrémités.
- Repita los pasos anteriores para ensamblar dos cerchas sin muescas a los dos extremos.

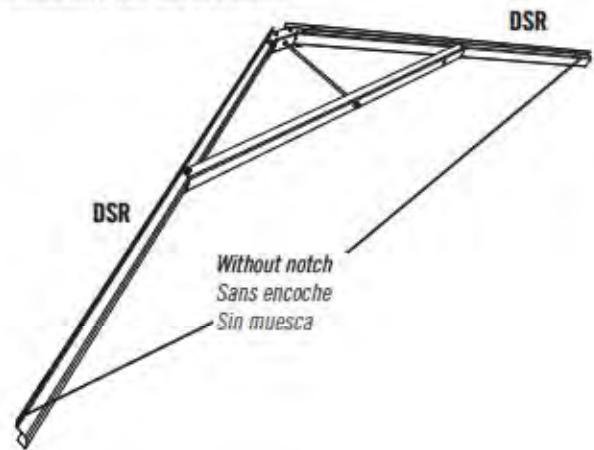
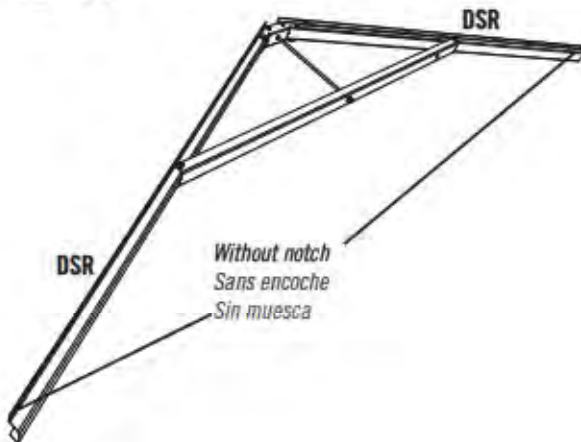

2.7

CENTER TRUSS (x1) / FERME CENTRALE (x1) / ARMAZÓN CENTRAL (x1)

- Attach a Connector (AIP) to the end of two Truss Gutter Channels (DSM & DSR) as shown.
- Attachez un raccord (AIP) à l'extrémité des canaux de gouttière (DSM et DSR) comme illustré.
- Sujete un connector (AIP) a los extremos de los canalones de la cercha (DSM y DSR) como se muestra.

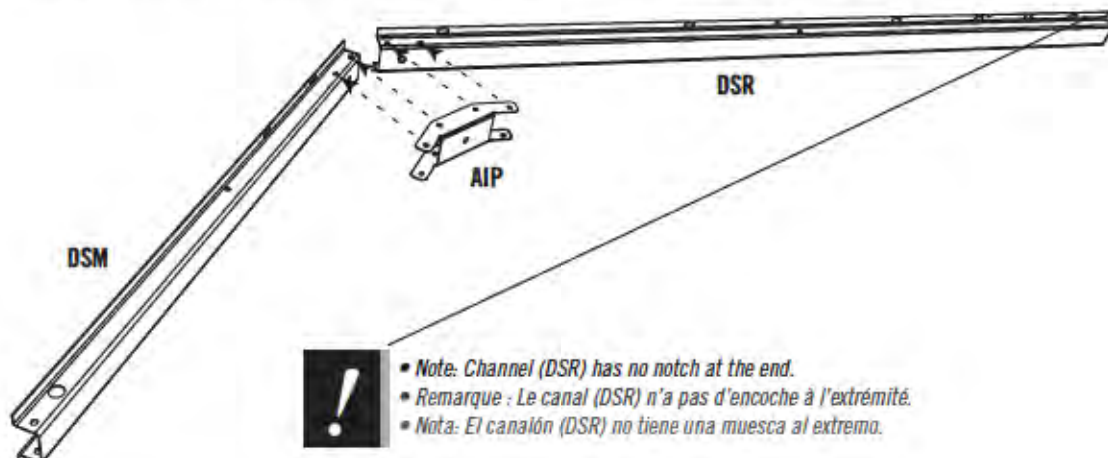

- **Note:** Channel (DSR) has no notch at the end.
- **Remarque:** Le canal (DSR) n'a pas d'encoche à l'extrémité.
- **Nota:** El canalón (DSR) no tiene una muesca al extremo.

► SECTION 2 (CONTINUED) / SECTION 2 (SUITE) / SECCIÓN 2 (CONTINUACIÓN)

TOOLS AND HARDWARE REQUIRED / OUTILS ET QUINCAILLERIE REQUIS / INSTRUMENTAL Y HERRAJE REQUERIDOS



3/8 in/po (x2)
(10 mm) (x2)



DTK (x4)



ADK (x6)

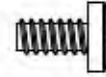

ADY (x2)

2.8

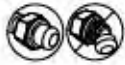

- Attach a **Connector (AIP)** to the end of two Truss Gutter Channels using the hardware provided. **Do not overtighten the Cap Nuts (ADJ).**

- Attachez un **raccord (AIP)** à l'extrémité des canaux de gouttière à l'aide de la quincaillerie incluse. **Ne pas trop serrer les écrous à chape (ADJ).**

- Sujete un **connector (AIP)** a los extremos de los canales de la cercha usando el herraje indicado. **No apriete demasiado las tuercas ciegas (ADJ).**

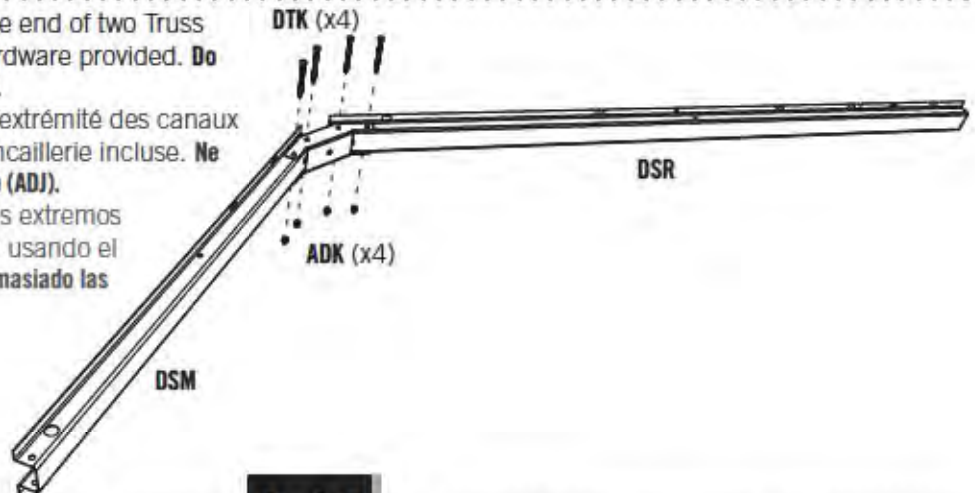

2.9

- Slide a **Truss Brace (AFG)** onto the Truss Gutter Channels as shown.

- Glissez un **support de la ferme (AFG)** sur les canaux de gouttière comme illustré.

- Deslice un **soporte de la cercha (AFG)** sobre los canales de la cercha como se muestra.

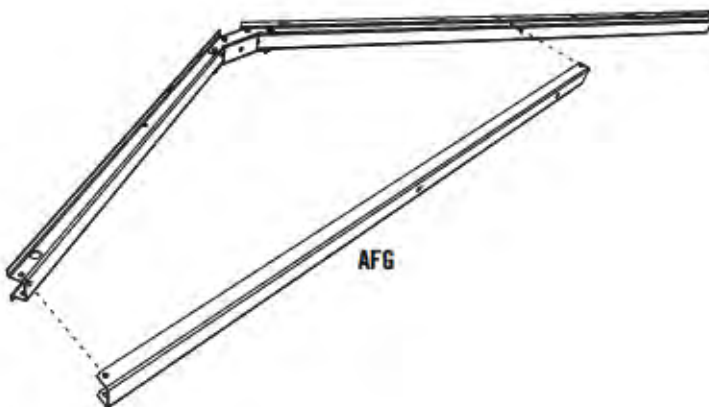

2.10

- Attach the Truss Brace using the hardware provided. **Do not overtighten.**

- Attachez le support de la ferme à l'aide de la quincaillerie incluse. **Ne serrez pas excessivement.**

- Sujete el soporte de la cercha usando el herraje indicado. **No apriete demasiado.**

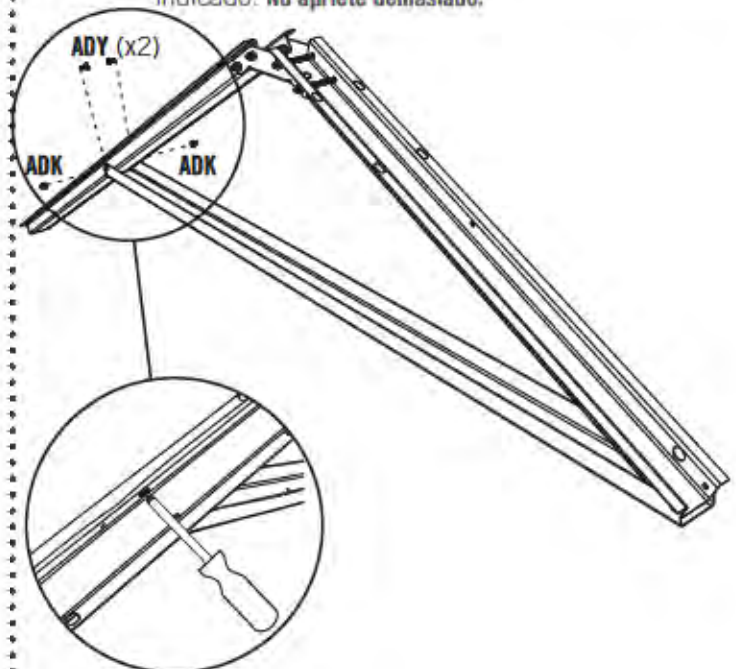

► SECTION 2 (CONTINUED) / SECTION 2 (SUITE) / SECCIÓN 2 (CONTINUACIÓN)

TOOLS AND HARDWARE REQUIRED / Outils et quincaillerie requis / Instrumental y herraje requeridos

3/8 in/po (x2)
(10 mm) (x2)



DTK (x2)



ADK (x1)



DTJ (x1)



CXK (x2)

2.11

- Attach the **Vertical Truss Brace (DSN)** to the Truss. Only finger tighten this **Nut (ADK)** for now.
- Attachez le **support vertical (DSN)** à la ferme. Serrez l'**écrou (ADK)** à la main pour le moment.
- Fije el **soporte vertical (DSN)** a la cercha. Apriete la **tuerca (ADK)** a mano por el momento.

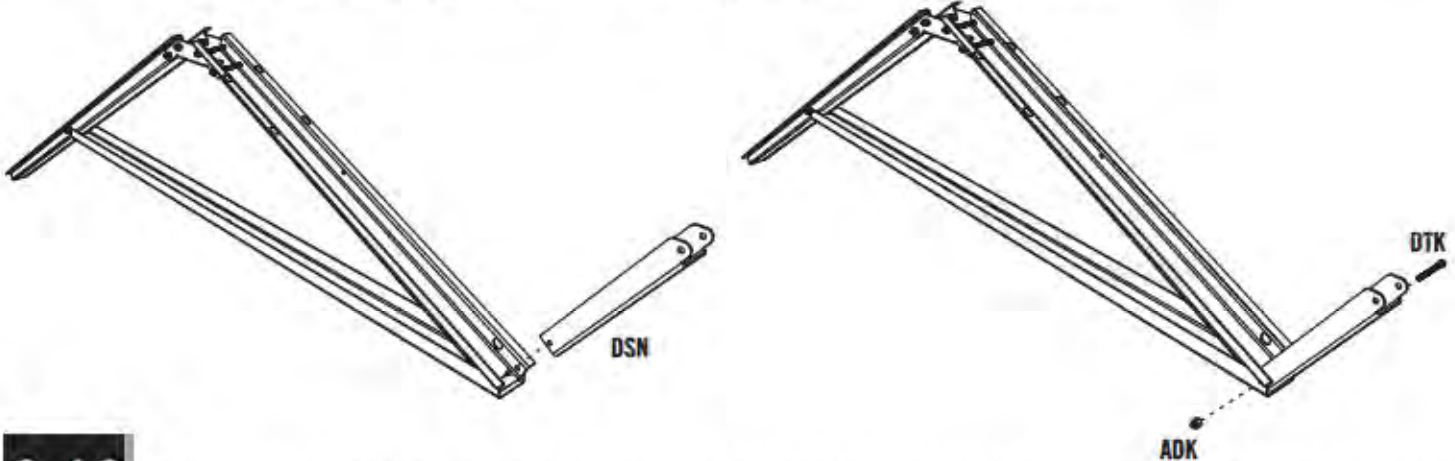

2.12

- Secure the **Horizontal Truss Brace (DSO)** to the Truss with the hardware shown. **Now, tighten the Nut from Step 2.11.**
- Attachez le **support horizontal (DSO)** à la ferme à l'aide de la quincaillerie incluse. **Maintenant, serrez l'écrou de l'étape 2.11.**
- Sujete el **soporte horizontal (DSO)** a la cercha usando el herraje indicado. **Ahora, apriete la tuerca del paso 2.11.**

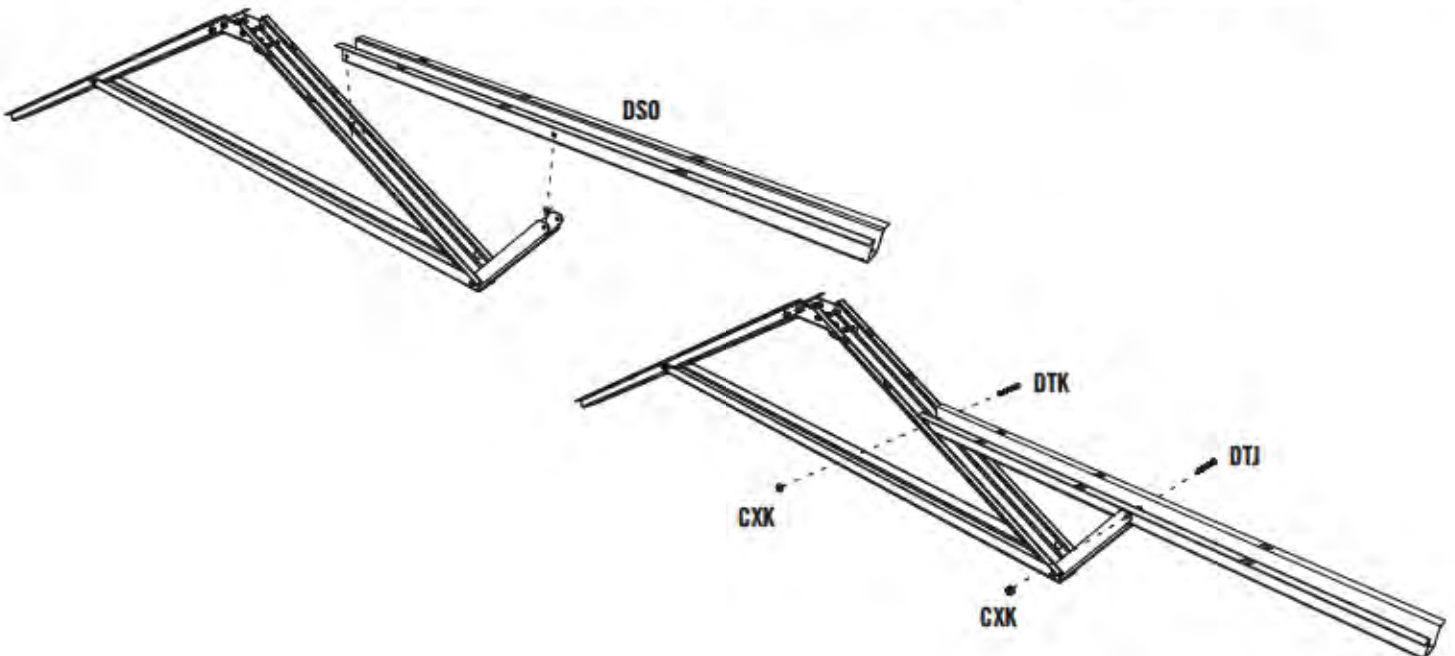

SECTION 2 (CONTINUED) / SECTION 2 (SUITE) / SECCIÓN 2 (CONTINUACIÓN)

TOOLS AND HARDWARE REQUIRED / OUTILS ET QUINCAILLERIE REQUIS / INSTRUMENTAL Y HERRAJE REQUERIDOS



7/16 in/po (x2)
(11 mm) (x2)

3/8 in/po (x2)
(10 mm) (x2)



ADJ (x2)

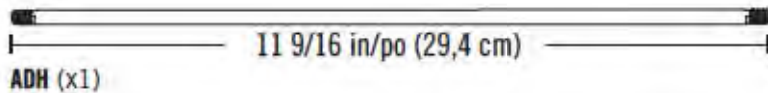

ADH (x1)



AHT (x1)

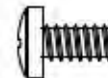

ADY (x1)



ADK (x1)

2.13

- Slide a **Truss Rod (ADH)** through the holes in the Brace and Connector. Secure with two **Cap Nuts (ADJ)**.
- Glissez une **tige (ADH)** à travers les trous dans le support et le raccord. Attachez-le bien à l'aide de deux **écrous à chape (ADJ)**.
- Deslice una **varilla (ADH)** a través de los agujeros en el soporte y el conector. Sujétela con dos **tuercas ciegas (ADJ)**.

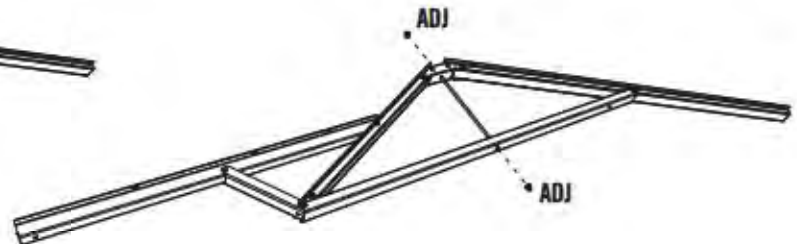
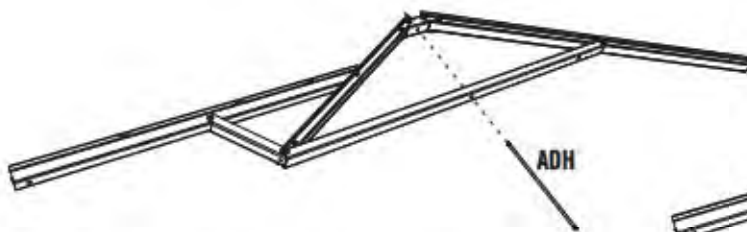

- **Note:** Do not overtighten the **Cap Nuts (ADJ)**.
- **Remarque :** Ne pas trop serrer les **écrous à chape (ADJ)**.
- **Nota:** No apriete demasiado las **tuercas ciegas (ADJ)**.

2.14

- Only tighten the **Nut (ADK)** by hand in this step.
- Ne serrez l'**écrou (ADK)** qu'à la main dans cette étape.
- Sólo apriete la **tuerca (ADK)** a mano en este paso.

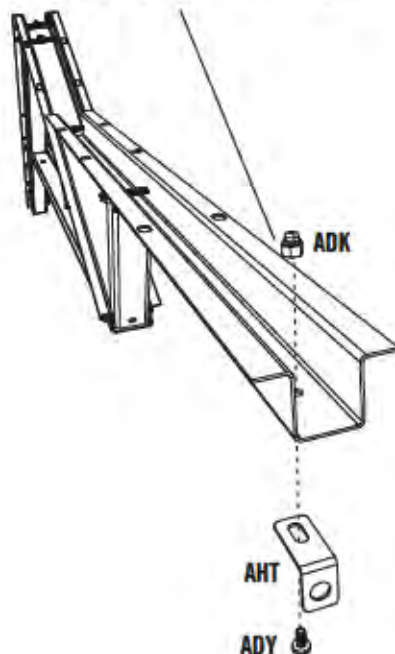

2.15

- Slide the **Support Tube (DSP)** through the hole in the Front Truss Channel and center it.
- Faites glisser le **tube de support (DSP)** à travers le trou dans le canal de gouttière avant et centrez-le.
- Deslice le **tubo de soporte (DSP)** a través del agujero en el canalón de la cercha delantero y centrélo.



- **Note:** This end will face the front of the shed.
- **Remarque :** Cette extrémité fera face à la partie avant de l'abri.
- **Nota:** Este extremo dará a la parte delantera de la caseta.

SECTION 2 (CONTINUED) / SECTION 2 (SUITE) / SECCIÓN 2 (CONTINUACIÓN)

TOOLS AND HARDWARE REQUIRED / OUTILS ET QUINCAILLERIE REQUIS / INSTRUMENTAL Y HERRAJE REQUERIDOS



7/16 in/po (x2)
(11 mm) (x2)



3/8 in/po (x2)
(10 mm) (x2)



ADJ (x2)



ADH (x1)

11 9/16 in/po (29,4 cm)



AHT (x1)

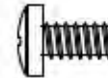

ADY (x1)



ADK (x1)

2.13

- Slide a **Truss Rod (ADH)** through the holes in the Brace and Connector. Secure with two **Cap Nuts (ADJ)**.
- Glissez une **tige (ADH)** à travers les trous dans le support et le raccord. Attachez-le bien à l'aide de deux **écrous à chape (ADJ)**.
- Deslice una **varilla (ADH)** a través de los agujeros en el soporte y el conector. Sujétela con dos **tuercas ciegas (ADJ)**.

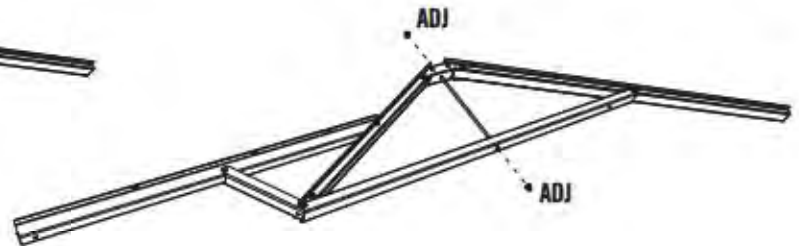

- **Note:** Do not overtighten the **Cap Nuts (ADJ)**.
- **Remarque :** Ne pas trop serrer les **écrous à chape (ADJ)**.
- **Nota:** No apriete demasiado las **tuercas ciegas (ADJ)**.

2.14

- Only tighten the **Nut (ADK)** by hand in this step.
- Ne serrez l'**écrou (ADK)** qu'à la main dans cette étape.
- Sólo apriete la **tuerca (ADK)** a mano en este paso.

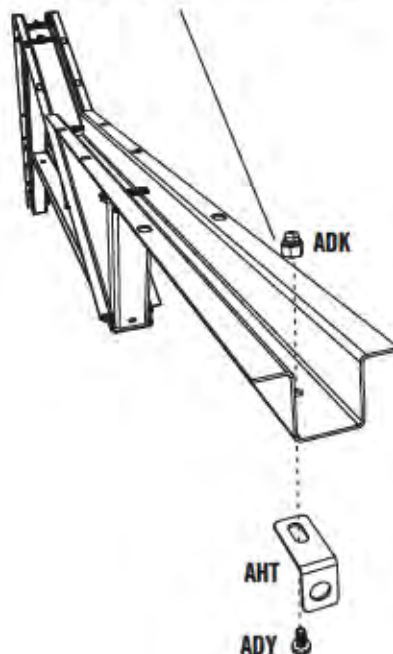

2.15

- Slide the **Support Tube (DSP)** through the hole in the Front Truss Channel and center it.
- Faites glisser le **tube de support (DSP)** à travers le trou dans le canal de gouttière avant et centrez-le.
- Deslice el **tubo de soporte (DSP)** a través del agujero en el canalón de la cercha delantero y centrélo.



- **Note:** This end will face the front of the shed.
- **Remarque :** Cette extrémité fera face à la partie avant de l'abri.
- **Nota:** Este extremo dará a la parte delantera de la caseta.

3

GABLE ASSEMBLY / ASSEMBLAGE DES PIGNONS / ENSAMBLE DE LAS FACHADAS



HARDWARE REQUIRED / QUINCAILLERIE REQUISE / HERRAJE REQUERIDO

Hardware Bag / Sac de quincaillerie / Bolsa de herraje

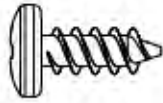

ADZ (x8)

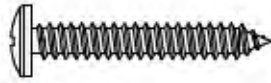

ACB (x0/2)



AGP (x2)

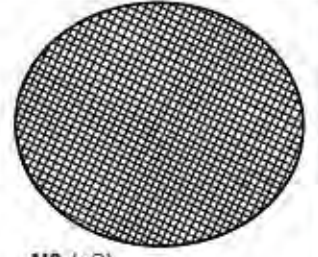

AIQ (x2)

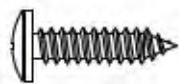

ADW (x10)

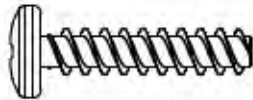

ADV (x10)



AEE (x10)



AHS (x4)



PARTS REQUIRED / PIÈCES REQUISES / PIEZAS REQUERIDAS

Metal Parts / Pièces en métal / Piezas de metal

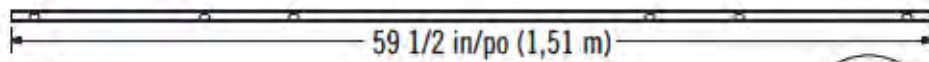

AFE (x1)

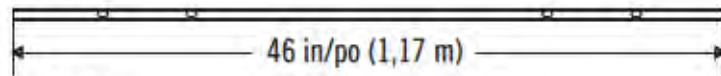

BDD (x1)

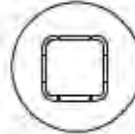
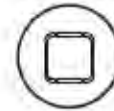

Plastic Parts / Pièces en plastique / Piezas de plástico



BDC (x1)

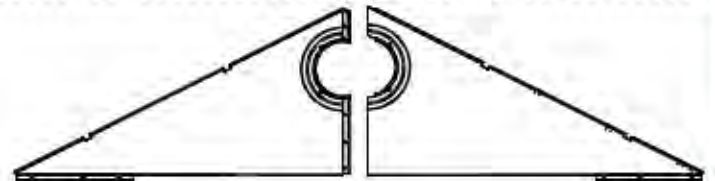

AGI (x1)

AGH (x1)



AGF (x1)



TOOLS REQUIRED / OUTILS REQUIS / INSTRUMENTAL REQUERIDO

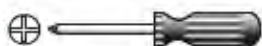

► SECTION 3 (CONTINUED) / SECTION 3 (SUITE) / SECCIÓN 3 (CONTINUACIÓN)

TOOLS AND HARDWARE REQUIRED / OUTILS ET QUINCAILLERIE REQUIS / INSTRUMENTAL Y HERRAJE REQUERIDOS

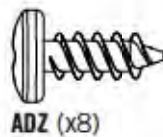

3.1

- Align the holes in the **Left (AGH)** and **Right (AGI)** Side Gable Halves.
- Alignez les trous dans les **pignons latéraux gauche (AGH)** et **droite (AGI)**.
- Alinee los agujeros en las **fachadas laterales izquierda (AGH)** y **derecha (AGI)**.

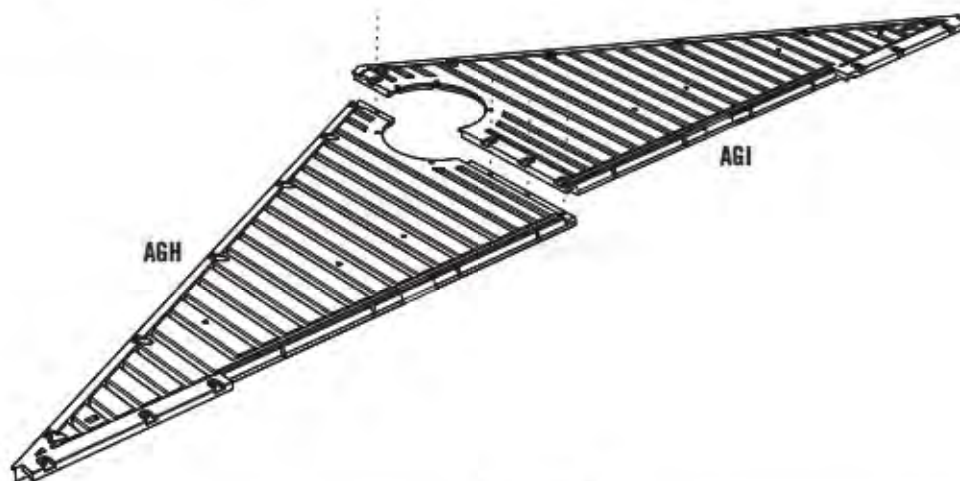

3.2

- Secure the two Gable Halves with four (4) **Screws (ADZ)**.
- Attachez l'un à l'autre à l'aide de quatre (4) **vis (ADZ)**.
- Sujete el uno al otro usando cuatro (4) **tornillos (ADZ)**.

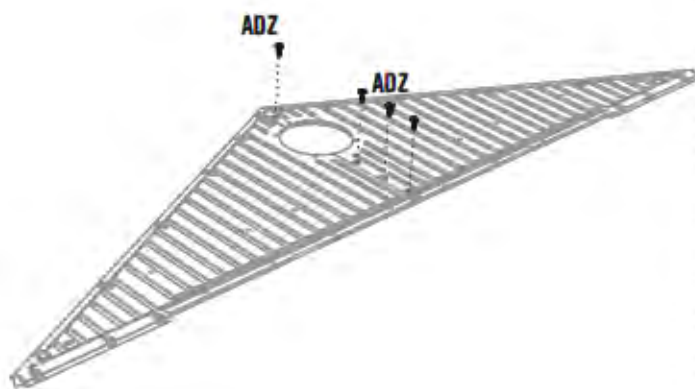

3.3

- Place the **Screen (AIQ)** over the **Vent (AGP)** and align the five holes in the Vent with those in the Gable.
- Mettez la **moustiquaire (AIQ)** sur l'**évent (AGP)**, et alignez les cinq trous dans l'évent avec ceux du pignon.
- Coloque el **mosquitero (AIQ)** sobre la **rejilla de ventilación (AGP)** y alinee los agujeros en la rejilla con los de la fachada.

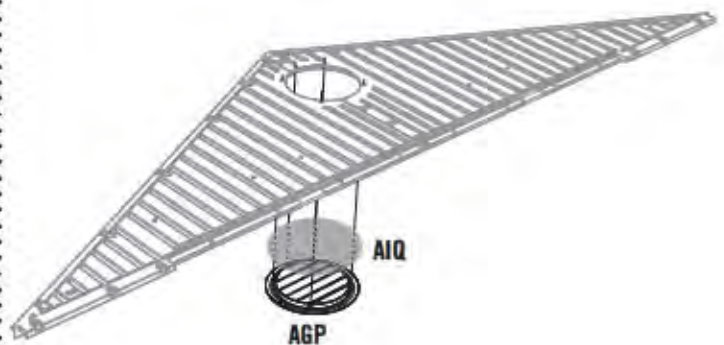

► SECTION 3 (CONTINUED) / SECTION 3 (SUITE) / SECCIÓN 3 (CONTINUACIÓN)

TOOLS AND HARDWARE REQUIRED / OUTILS ET QUINCAILLERIE REQUIS / INSTRUMENTAL Y HERRAJE REQUERIDOS

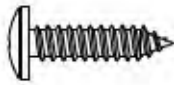

ADW (x10)



AEE (x10)



AHS (x2)

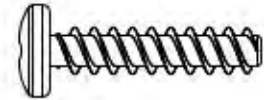

ADV (x4)

3.4

- Secure with the hardware provided.
- Attachez les uns aux autres de la quincaillerie incluse.
- Sujete los unos a los otros usando el herraje incluido.

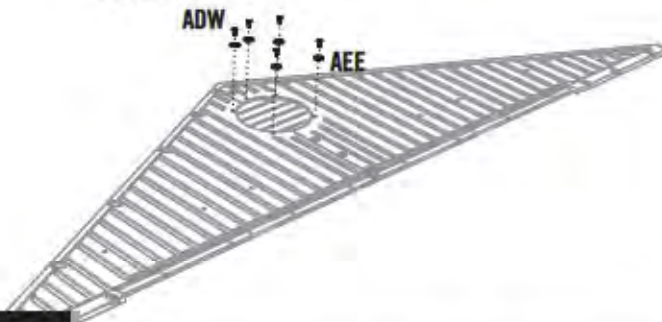

3.5

- Insert an **End Cap (AHS)** into each end of the **Header Bar (BDD)**.
- Insérez un **capuchon (AHS)** dans chaque extrémité du **linteau (BDD)**.
- Inserte un **tapón (AHS)** en los dos extremos del **dintel (BDD)**.

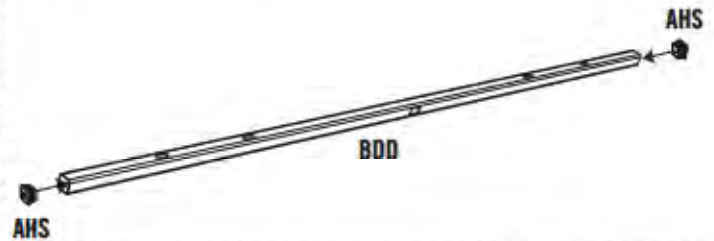

3.6

- Align the holes in the Header with those in the Front Entry Gable. Secure with the hardware provided.
- Alignez les trous dans le linteau avec ceux du pignon d'entrée avant. Attachez les uns aux autres de la quincaillerie incluse.
- Alinee los agujeros en el dintel con ellos en la fachada de entrada delantera. Sujete los unos a los otros usando el herraje incluido.



- The flat holes face away from the Gable.
- Les trous plats doivent être face à l'écart du pignon.
- Los agujeros planos dan hacia afuera.

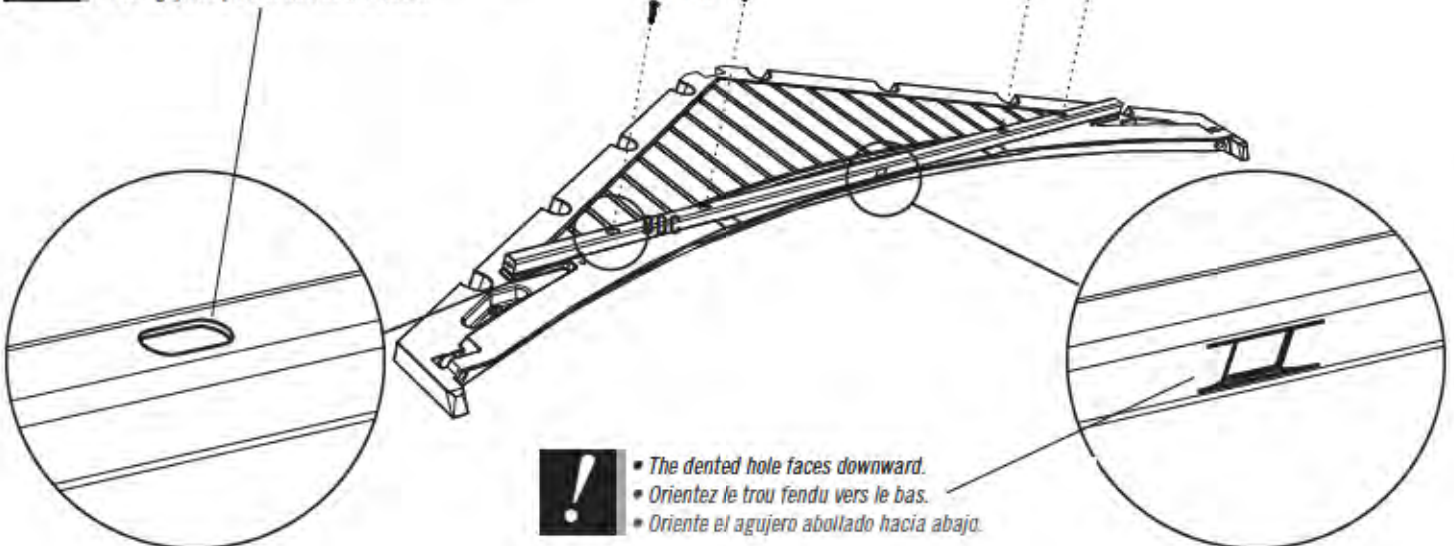

- The dented hole faces downward.
- Orientez le trou fendu vers le bas.
- Oriente el agujero abollado hacia abajo.

► SECTION 3 (CONTINUED) / SECTION 3 (SUITE) / SECCIÓN 3 (CONTINUACIÓN)

TOOLS AND HARDWARE REQUIRED / OUTILS ET QUINCAILLERIE REQUIS / INSTRUMENTAL Y HERRAJE REQUERIDOS

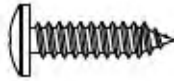

ADW (x5)



AEE (x5)



AHS (x2)

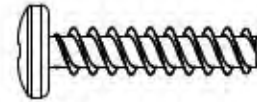

ADV (x6)

3.7

- Place the **Screen (AIQ)** over the **Vent (AGP)** and align the five holes in the Vent with those in the **Entry Gable (AGF)**.
- Mettez la **moustiquaire (AIQ)** sur l'**évent (AGP)**, et alignez les cinq trous dans l'évent avec ceux du **pignon d'entrée (AGF)**.
- Coloque el **mosquitero (AIQ)** sobre la **rejilla de ventilación (AGP)** y alinee los agujeros en la rejilla con los de la **fachada de entrada (AGF)**.

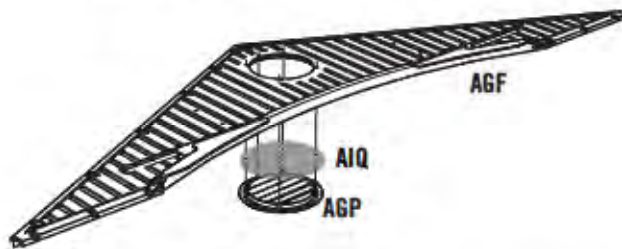

3.8

- Secure with the hardware provided.
- Attachez les uns aux autres de la quincaillerie incluse.
- Sujete los unos a los otros usando el herraje incluido.

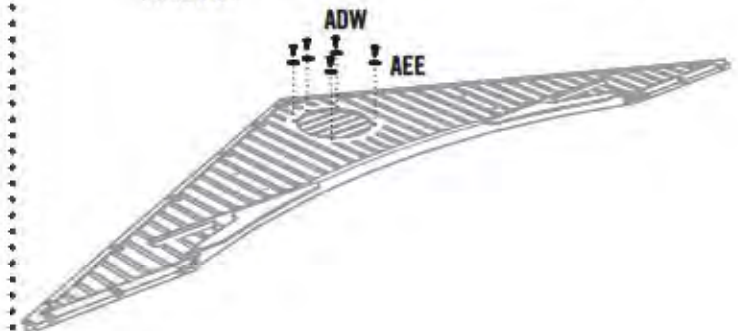

3.9

- The flat holes face away from the Gable.
- Les trous plats doivent être face à l'écart du pignon.
- Los agujeros planos dan hacia afuera.

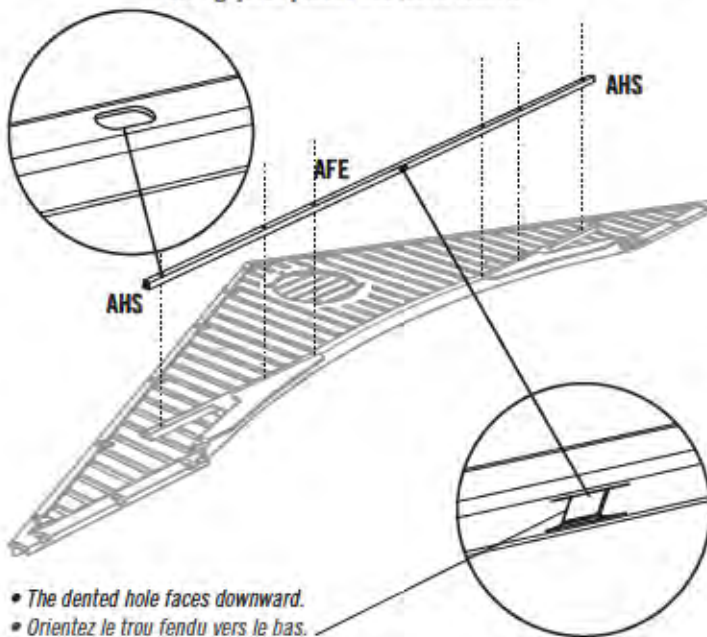

- The dented hole faces downward.
- Orientez le trou fendu vers le bas.
- Oriente el agujero abollado hacia abajo.

3.10

- Secure with the hardware provided.
- Attachez les uns aux autres de la quincaillerie incluse.
- Sujete los unos a los otros usando el herraje incluido.

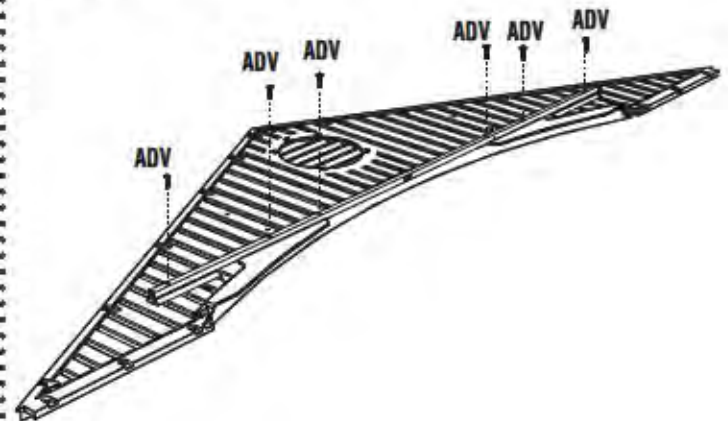

4 LEFT DOOR ASSEMBLY / ASSEMBLAGE DE LA PORTE GAUCHE / ENSAMBLE DE LA PUERTA IZQUIERDA



HARDWARE REQUIRED / QUINCAILLERIE REQUISE / HERRAJE REQUERIDO

Hardware Bag / Sac de quincaillerie / Bolsa de herraje

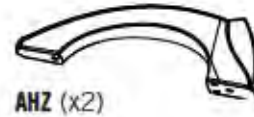
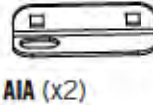
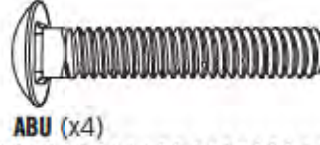
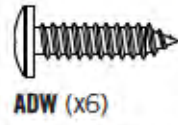

PARTS REQUIRED / PIÈCES REQUISES / PIEZAS REQUERIDAS

Metal Parts / Pièces en métal / Piezas de metal

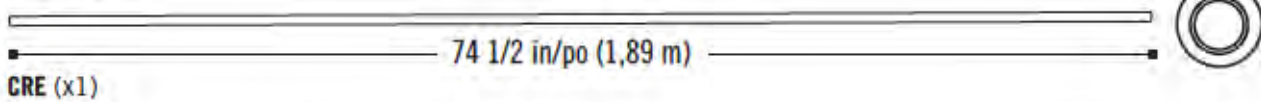
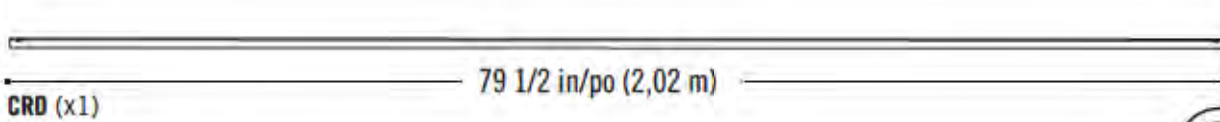
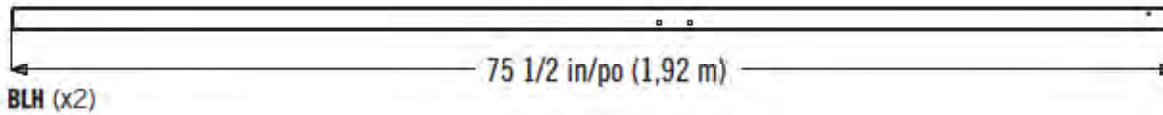

Plastic Parts / Pièces en plastique / Piezas de plástico

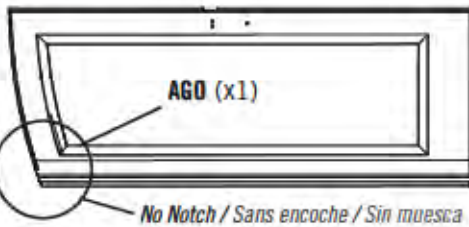

TOOLS REQUIRED / OUTILS REQUIS / INSTRUMENTAL REQUERIDO



7/16 in/po (11 mm)

► SECTION 4 (CONTINUED) / SECTION 4 (SUITE) / SECCIÓN 4 (CONTINUACIÓN)

TOOLS AND HARDWARE REQUIRED / OUTILS ET QUINCAILLERIE REQUIS / INSTRUMENTAL Y HERRAJE REQUERIDOS



- If you have trouble with this section, follow the code below to view a video on the assembly in this section.
- Si tiene problemas con esta sección, siga el código debajo para ver un video sobre el ensamble en esta sección.
- Si vous avez des problèmes avec cette section, suivez le code en bas pour voir un vidéo sur l'assemblage dans cette section.

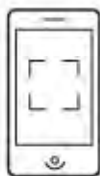

<http://go.lifetime.com/leftdoor8foot>

4.1

- Slide a **Hinge Tube (CRD)** down into the hole at the top of the **Left Door (AGO)**.
- Glissez le **tube d'articulation (CRD)** dans le trou au bord supérieur de la **porte gauche (AGO)**.
- Deslice el **tubo de articulación (CRD)** en el agujero a la parte superior de la **puerta izquierda (AGO)**.

CRD (x1)

79 1/2 in/po (2,02 m)

CRD

AGO (x1)

AGO

No Notch / Sans encoche / Sin muesca

- **Note:** Door Channels (BLH) are bowed by design ensuring a tight fit when closed and latched, making your shed more secure. These channels are formed with a slight bend to the adjoining door edge—like parentheses facing each other: (). When the door handle is gently closed and latched, there should be a slight pressure sealing the doors and eliminating any gaps. Read the step-by-step instructions carefully to successfully install the door channels.

• **Remarque :** Les canaux pour le bord des portes (BLH) se courben à dessein en s'assurant un ajustage lorsque les portes se ferment, en faisant votre abri plus sûre. Ces canaux sont fabriqués avec une légère courbe au bord de la porte adjacente — comme les parenthèses qui font face l'une l'autre : (). Lorsque la poignée se ferme, il devrait un légère pression en rebouchant les portes et en éliminant des ouvertures. Lisez avec soin les instructions étape par étape pour pouvoir installer avec succès les canaux pour le bord des portes.

• **Nota:** Los canales para el borde de las puertas (BLH) curvan por diseño asegurando un ajuste fijo cuando las puertas estén cerrados con pestillo, haciendo su caseta más segura. Estos canales están formados con una curva ligera al borde de la puerta adyacente, como los paréntesis uno enfrente al otro: (). Cuando el picaporte esté ligeramente cerrado con pestillo, debería tener una presión ligera sellando las puertas y eliminando los espacios. Lea detenidamente las instrucciones paso a paso para poder instalar exitosamente los canales para el borde de las puertas.

BLH

► SECTION 4 (CONTINUED) / SECTION 4 (SUITE) / SECCIÓN 4 (CONTINUACIÓN)

TOOLS AND HARDWARE REQUIRED / OUTILS ET QUINCAILLERIE REQUIS / INSTRUMENTAL Y HERRAJE REQUERIDOS



AHM (x4)

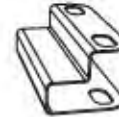

DZG (x1)

4.2

- Set the **Deadbolts (AHM)** down into the recesses at the top and bottom of the Door. Then, slide the **Door End Channel (BLH)** over the edge of the Door and the bottom of the Deadbolts as shown.
- Mettez les **loquets à pêne dormant (AHM)** dans les espaces vides aux parties supérieure et inférieure de la porte. Ensuite, faites glisser le **canal de la porte (BLH)** sur le bord de la porte et les parties inférieures des loquets à pêne dormant comme illustré.
- Ponga los **cerrojos (AHM)** en los huecos a las partes superior e inferior de la puerta. Entonces, deslice el **canal para el borde de la puerta (BLH)** sobre el borde de la puerta y las partes inferiores de los cerrojos como se muestra.

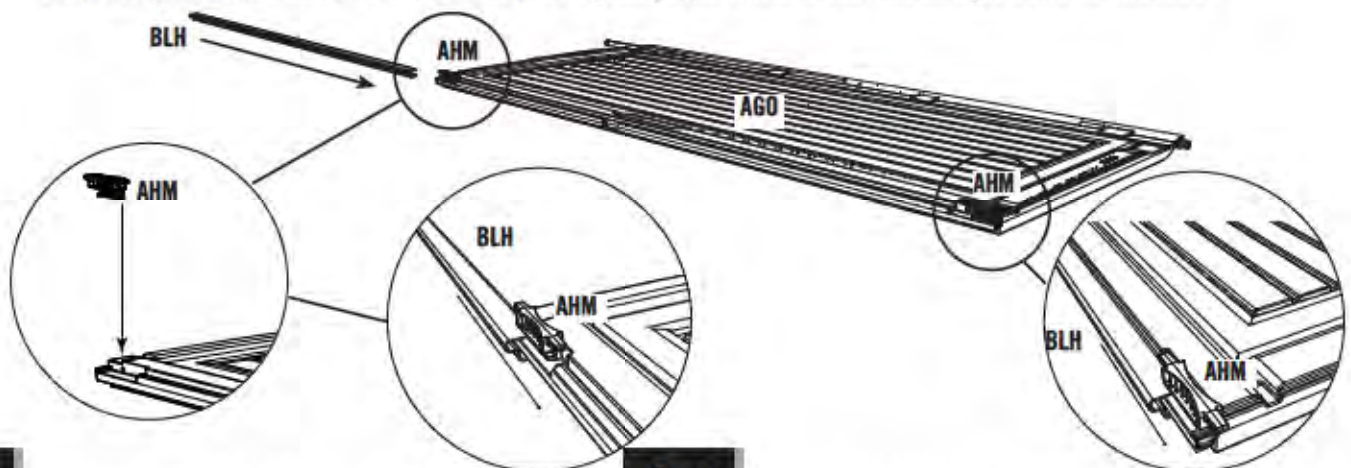

4.3

- *Note: The Deadbolts are used for locking the door. They may not move freely at first. You may need to tap them up and down a few times with a rubber mallet to work them in.*
- *Remarque : On utilise les Loquets pour fermer la porte. Au début, il se peut que les loquets ne se déplaceraient librement. Vous devrez peut-être les taper légèrement à l'aide d'un maillet en caoutchouc pour les desserrer.*
- *Nota: Se usan los cerrojos para cerrar la puerta. Al principio, pueden que no se desplacen libremente. Puede que necesite darlos unos golpecitos con un mazo de goma para aflojarlos.*

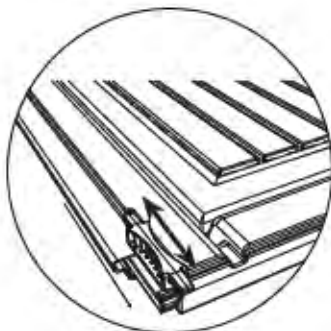

4.4

- Slide the **Strike Plate (DZG)** over the Door End Channel, and align the holes.
- Glissez la **gâche (DZG)** sur le canal de la porte, et alignez les trous.
- Deslice la **placa de impacto (DZG)** sobre el canal de la puerta, y alinee los agujeros.

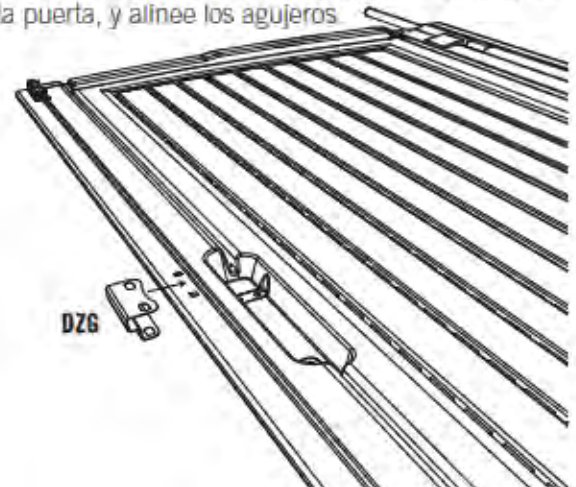

► SECTION 4 (CONTINUED) / SECTION 4 (SUITE) / SECCIÓN 4 (CONTINUACIÓN)

TOOLS AND HARDWARE REQUIRED / OUTILS ET QUINCAILLERIE REQUIS / INSTRUMENTAL Y HERRAJE REQUERIDOS



7/16 in/po
(11 mm)

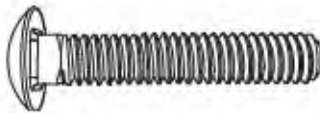

ABU (x4)

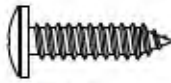

ADW (x6)



AHZ (x2)



DZG (x1)



AIA (x2)



AEE (x6)



ADJ (x4)

4.5

- Attach the **Door Latch (AIA)** to the Door using the hardware included. **Do not overtighten.**
- Attachez le **loquet (AIA)** à la porte à l'aide de la quincaillerie incluse. **Ne pas trop serrer.**
- Sujete la **placa de cierre (AIA)** a la puerta usando el herraje incluido. **No apriete demasiado.**

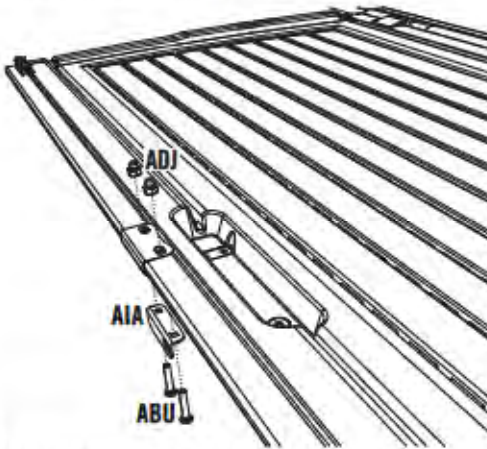

4.6

- Attach the **Handle (AHZ)** using the hardware included.
- Attachez la **poignée (AHZ)** à l'aide de la quincaillerie incluse.
- Sujete el **picaporte (AHZ)** usando el herraje incluido.

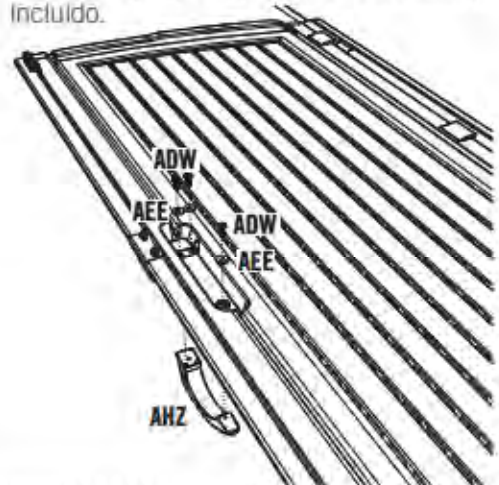

4.7

- Repeat the previous steps with these parts.
- Répétez les étapes précédentes à l'aide de ces pièces.
- Repita los pasos anteriores con estas piezas.

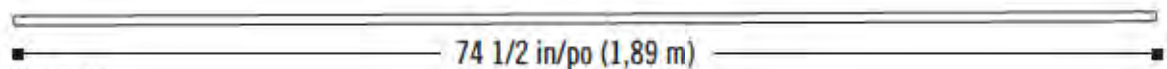
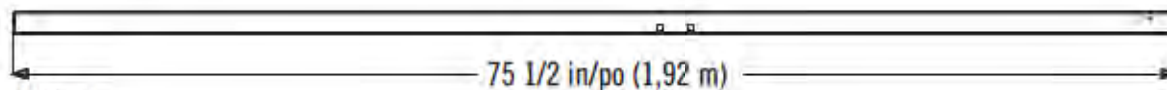
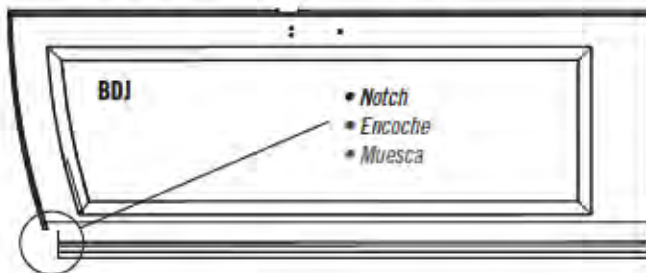

5

RIGHT DOOR ASSEMBLY / ASSEMBLAGE DE LA PORTE DROITE / ENSAMBLE DE LA PUERTA DERECHA



HARDWARE REQUIRED / QUINCAILLERIE REQUISE / HERRAJE REQUERIDO

Hardware Bags / Bolsas de herraje / Sacs de quincaillerie

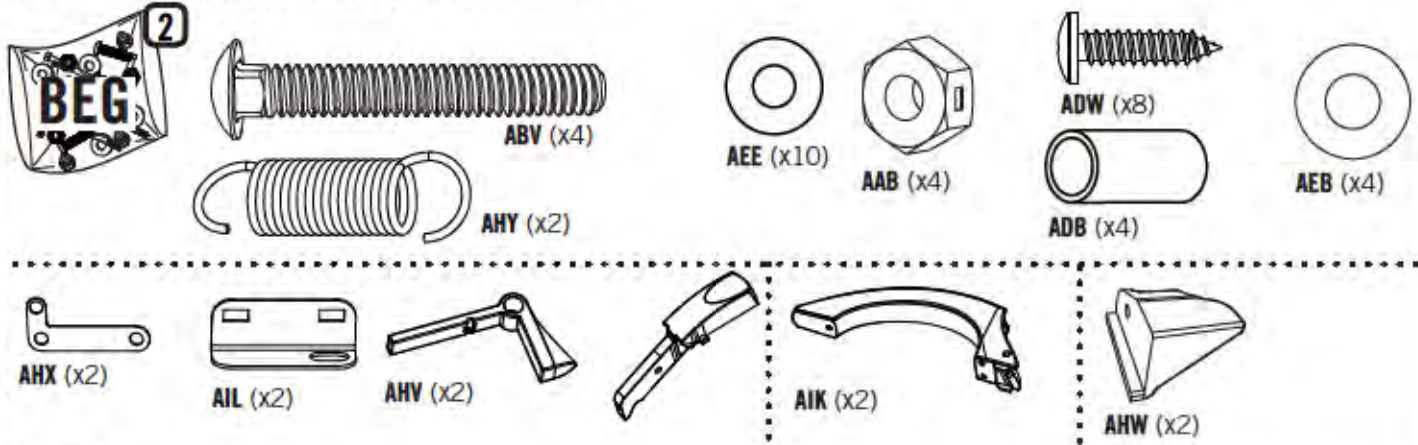

PARTS REQUIRED / PIÈCES REQUISES / PIEZAS REQUERIDAS

Metal Parts / Pièces en métal / Piezas de metal

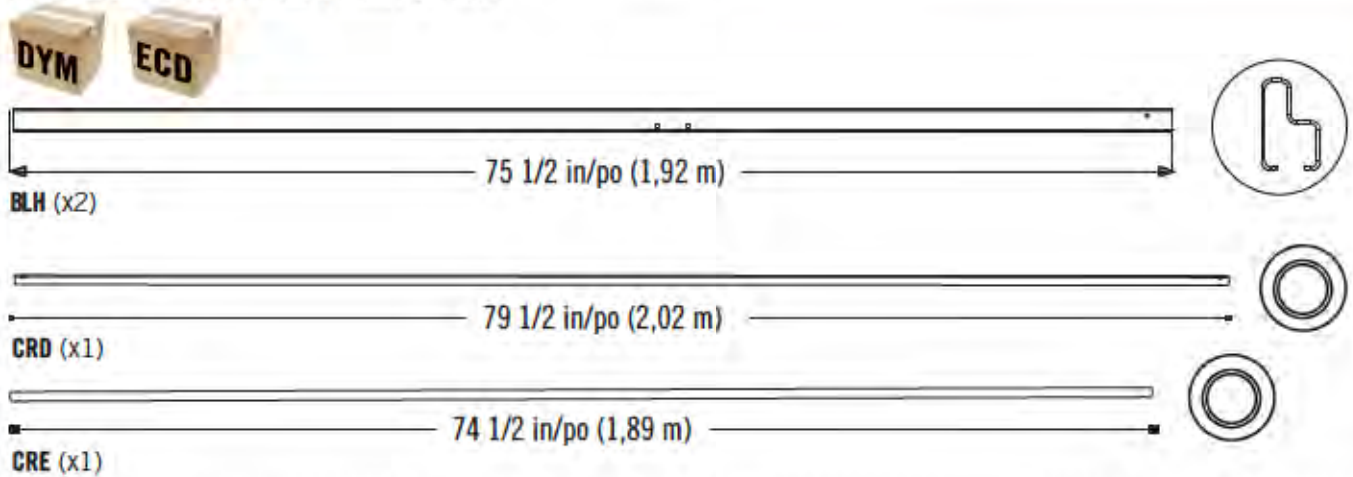

Plastic Parts / Pièces en plastique / Piezas de plástico

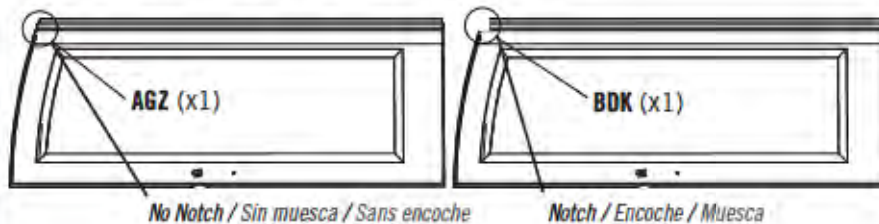

TOOLS REQUIRED / INSTRUMENTAL REQUERIDO / OUTILS REQUIS



► SECTION 5 (CONTINUED) / SECTION 5 (SUITE) / SECCIÓN 5 (CONTINUACIÓN)

TOOLS AND HARDWARE REQUIRED / OUTILS ET QUINCAILLERIE REQUIS / INSTRUMENTAL Y HERRAJE REQUERIDOS



- If you have trouble with this section, follow the code below to view a video on the assembly in this section.
- Si vous avez des problèmes avec cette section, suivez le code en bas pour voir un vidéo sur l'assemblage dans cette section.
- Si tiene problemas con esta sección, siga el código debajo para ver un video sobre el ensamble en esta sección.

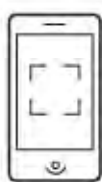

<http://go.lifetime.com/rightdoor8ft>

5.1

- Slide a **Hinge Tube (CRD)** down into the hole at the top of the **Right Door (AGZ)**.
- Glissez le **tube d'articulation (CRD)** dans le trou au bord supérieur de la **porte droite (AGZ)**.
- Deslice el **tubo de articulación (CRD)** en el agujero a la parte superior de la **puerta derecha (AGZ)**.

CRD (x1)

79 1/2 in/ps (2,02 m)

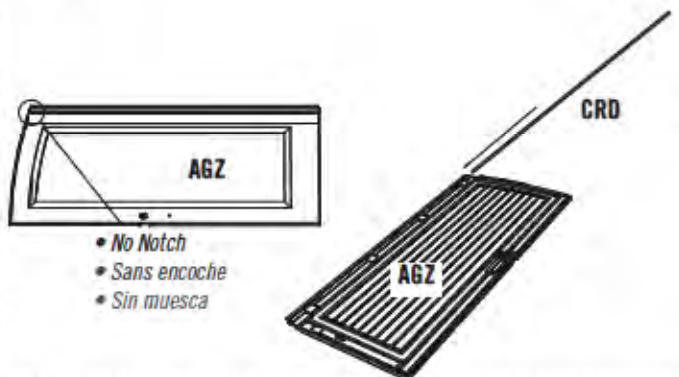

- No Notch
- Sans encoche
- Sin muesca



- **Door Channels (BLH)** are bowed by design ensuring a tight fit when closed and latched, making your shed more secure. These channels are formed with a slight bend to the adjoining door edge—like parentheses facing each other: (). When the door handle is gently closed and latched, there should be a slight pressure sealing the doors and eliminating any gaps. Read the step-by-step instructions carefully to successfully install the door channels.
- **Les canaux pour le bord des portes (BLH)** se courben à dessein en s'assurant un ajustage lorsque les portes se ferment, en faisant votre abri plus sûr. Ces canaux sont fabriqués avec une légère courbe au bord de la porte adjacente — comme les parenthèses qui font face l'une l'autre : (). Lorsque la poignée se ferme, il devrait un légère pression en rebouchant les portes et en éliminant des ouvertures. Lisez avec soin les instructions étape par étape pour pouvoir installer avec succès les canaux pour le bord des portes.
- **Los canales para el borde de las puertas (BLH)** curvan por diseño asegurando un ajuste fijo cuando las puertas estén cerrados con pestillo, haciendo su caseta más segura. Estos canales están formados con una curva ligera al borde de la puerta adjacente, como los paréntesis uno enfrente al otro: (). Cuando el picaporte esté ligeramente cerrado con pestillo, debería tener una presión ligera sellando las puertas y eliminando los espacios. Lea detenidamente las instrucciones paso a paso para poder instalar exitosamente los canales para el borde de las puertas.

BLH

► SECTION 5 (CONTINUED) / SECTION 5 (SUITE) / SECCIÓN 5 (CONTINUACIÓN)

TOOLS AND HARDWARE REQUIRED / OUTILS ET QUINCAILLERIE REQUIS / INSTRUMENTAL Y HERRAJE REQUERIDOS



AIO (x2)



AIK (x2)

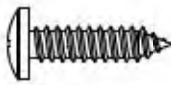

ADW (x6)



AEE (x6)

5.2

- Slide the **Door End Channel (BLH)** over the edge of the Door as shown.
- Faites glisser le **canal de la porte (BLH)** sur le bord de la porte comme illustré.
- Deslice el **canal para el borde de la puerta (BLH)** sobre el borde de la puerta como se muestra.

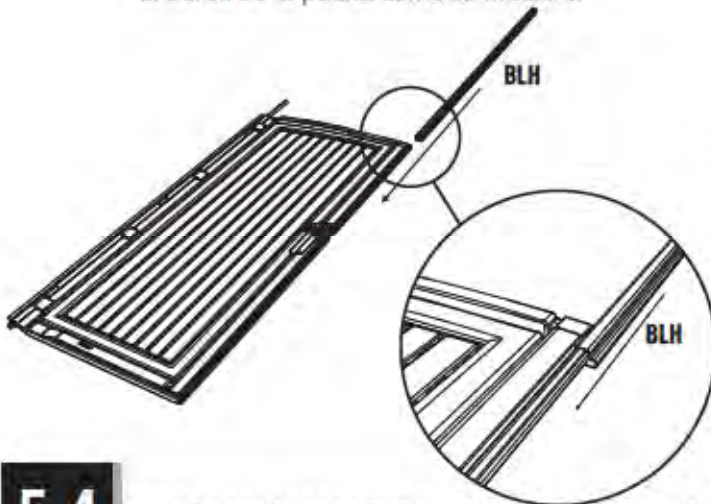

5.3

- Slide the **Thumb Lever (AIO)** down into the grooves in the **Door Handle (AIK)** until the nubs fit into the holes.
- Glissez le **levier poussoir (AIO)** dans les rainures de la **poignée (AIK)** jusqu'à ce que les petites bosses se fixent dans les trous.
- Deslice la **palanca de pulgar (AIO)** en las ranuras del **picaporte (AIK)** hasta que los nudos se encajen en los agujeros.

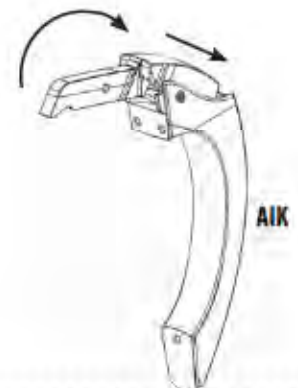

5.4

- Attach the Handle using the hardware included.
- Attachez la poignée à l'aide de la quincaillerie incluse.
- Sujete el picaporte usando el herraje incluido.

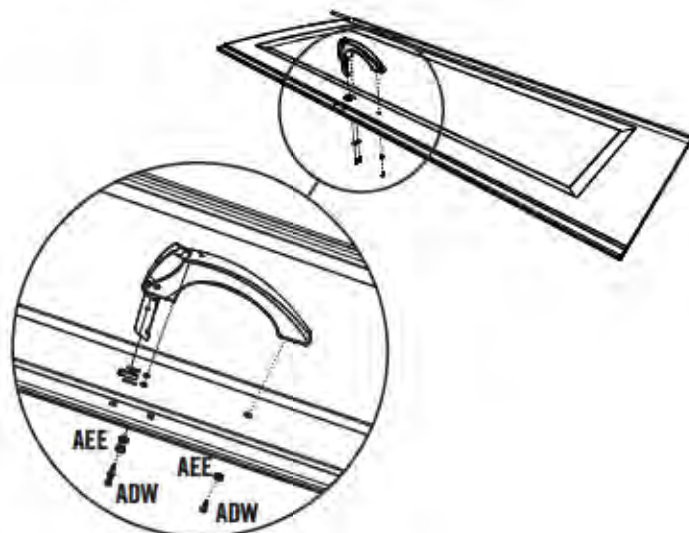

► SECTION 5 (CONTINUED) / SECTION 5 (SUITE) / SECCIÓN 5 (CONTINUACIÓN)

TOOLS AND HARDWARE REQUIRED / OUTILS ET QUINCAILLERIE REQUIS / INSTRUMENTAL Y HERRAJE REQUERIDOS



7/16 in/po
(11 mm)



AIL (x2)



AAB (x4)

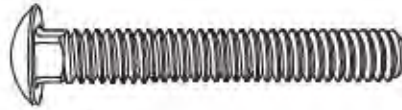

ABV (x4)

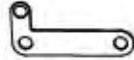

AHX (x2)



AHV (x2)

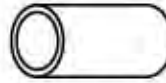

ADB (x4)



AEB (x4)

5.5

- Attach the Locking Hardware using the hardware included. **The arm of the Latch rests on top of the Thumb Lever.**
- Attachez les accessoires de verrouillage à l'aide de la quincaillerie incluse. **Le bras du loquet doit rester sur le levier poussoir.**
- Sujete los accesorios de cierre usando el herraje incluido. **El brazo del pestillo se queda sobre la palanca de pulgar.**

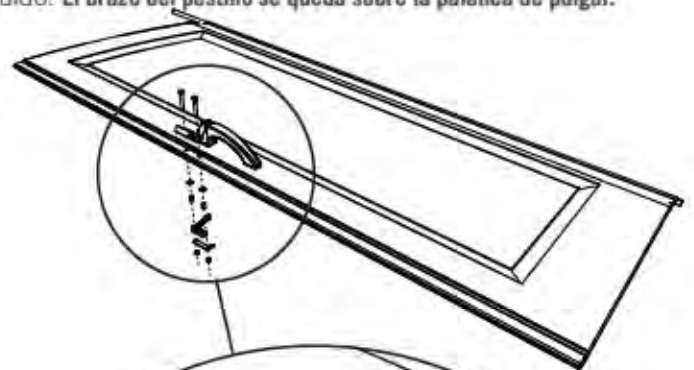

Thumb Lever
Levier poussoir
Palanca de pulgar

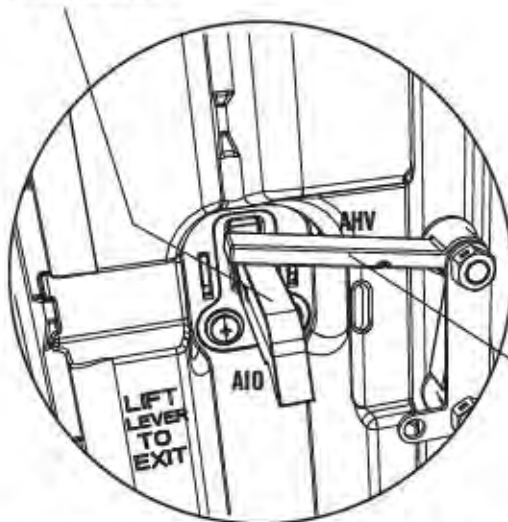

Arm of Latch
Bras du loquet
Brazo del pestillo

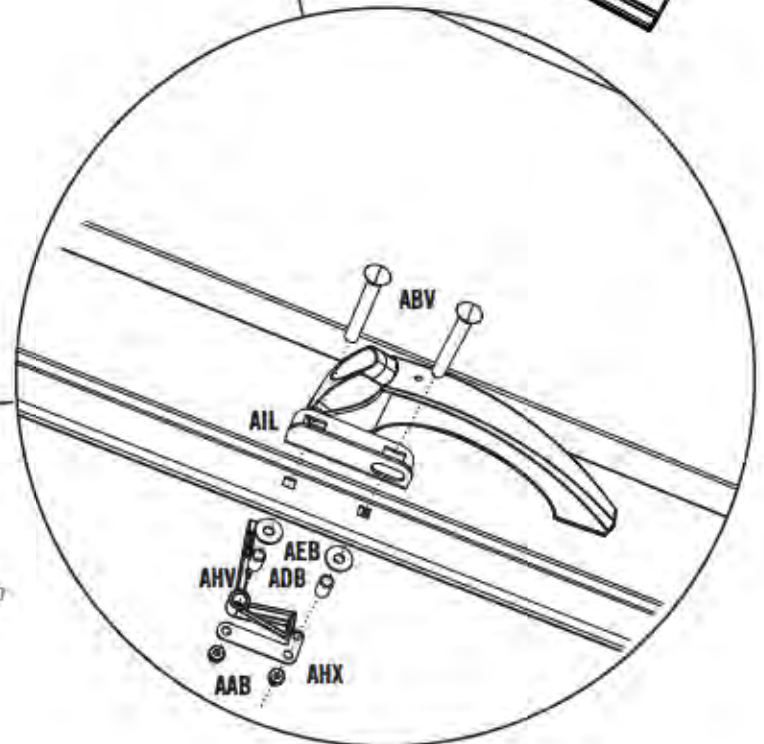

Rear of Door / Arrière de la porte / Trasero de la puerta

► SECTION 5 (CONTINUED) / SECTION 5 (SUITE) / SECCIÓN 5 (CONTINUACIÓN)

TOOLS AND HARDWARE REQUIRED / OUTILS ET QUINCAILLERIE REQUIS / INSTRUMENTAL Y HERRAJE REQUERIDOS:

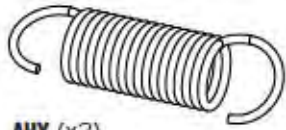

AHY (x2)

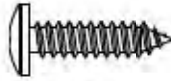

ADW (x2)



AHW (x2)

5.6

- Attach the **Bracket (AHW)** using a **Screw (ADW)**, and attach the **Spring (AHY)**.
- Attachez le **support (AHW)** à l'aide d'une **vis (ADW)**, et attachez le **ressort (AHY)**.
- Sujete el **soporte (AHW)** usando un **tornillo (ADW)**, y sujete el **resorte (AHY)**.

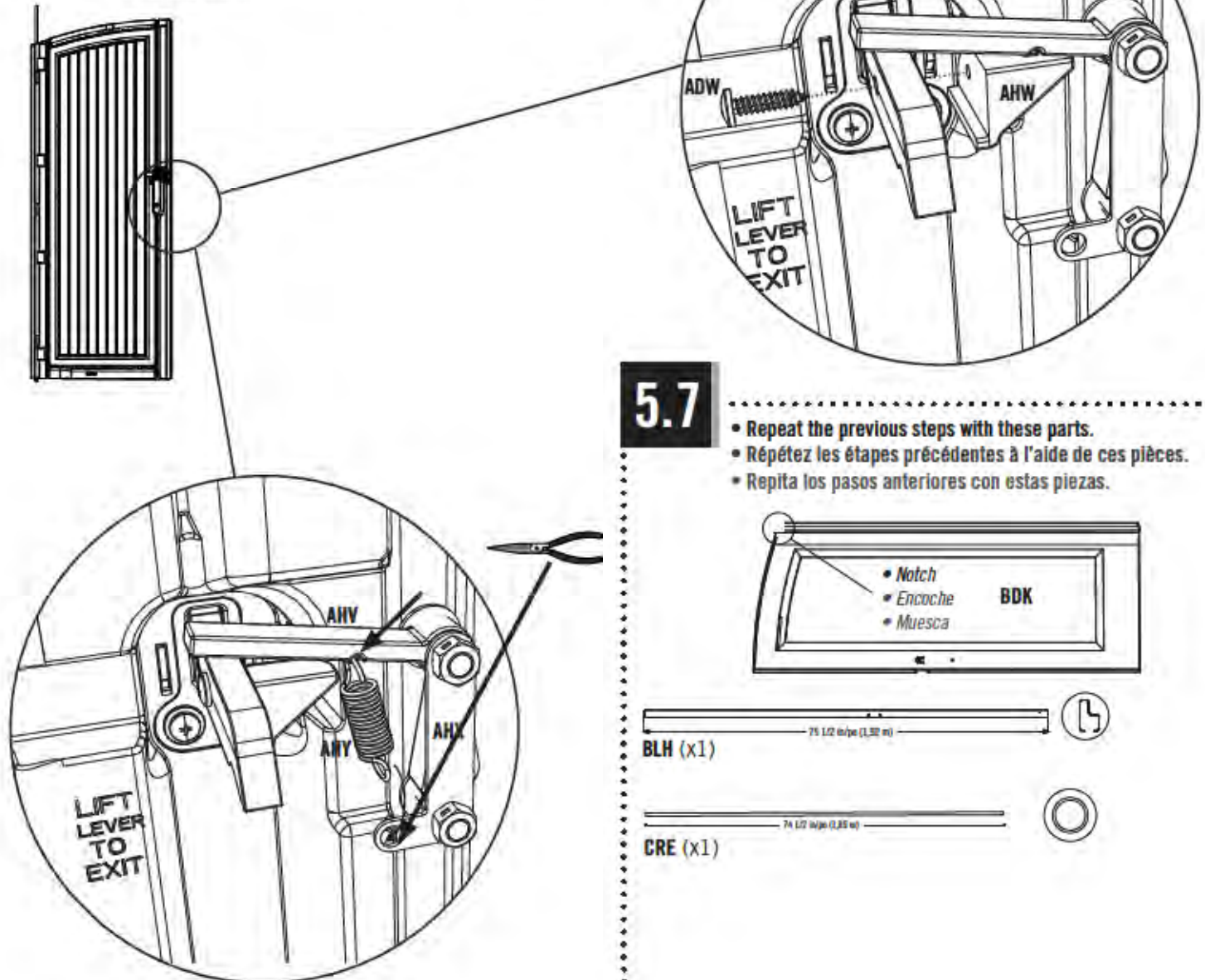

5.7

- Repeat the previous steps with these parts.
- Répétez les étapes précédentes à l'aide de ces pièces.
- Repita los pasos anteriores con estas piezas.

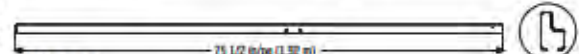
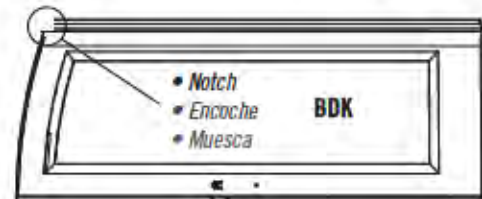

BLH (x1)



CRE (x1)

6

DOMED SKYLIGHT ASSEMBLY / ASSEMBLAGE DES LUCARNES EN FORME DE DÔME / ENSEMBLE DE LOS TRAGALUCES EN FORMA DE CÚPULA



HARDWARE REQUIRED / QUINCAILLERIE REQUISE / HERRAJE REQUERIDO

Hardware Bag / Sac de quincaillerie / Bolsa de herraje



EFA (x24)



ADK (x24)



AEE (x48)



AHI (x2)



PARTS REQUIRED / PIÈCES REQUISES / PIEZAS REQUERIDAS

Plastic Parts / Pièces en plastique / Piezas de plástico

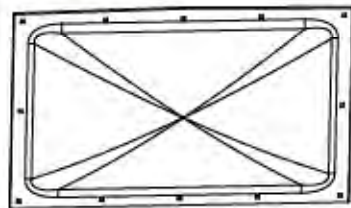

AGB (x2)

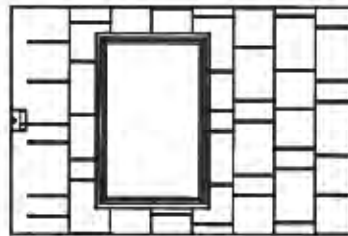

AHB (x2)



TOOLS REQUIRED / OUTILS REQUIS / INSTRUMENTAL REQUERIDO

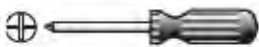

3/8 in/po (10 mm)

► SECTION 6 (CONTINUED) / SECTION 6 (SUITE) / SECCIÓN 6 (CONTINUACIÓN)

TOOLS AND HARDWARE REQUIRED / OUTILS ET QUINCAILLERIE REQUIS / INSTRUMENTAL Y HERRAJE REQUERIDOS



AHI (x2)



- If you have trouble with this section, follow the code below to view a video on the assembly in this section.
- Si vous avez des problèmes avec cette section, suivez le code en bas pour voir un vidéo sur l'assemblage dans cette section.
- Si tiene problemas con esta sección, siga el código debajo para ver un video sobre el ensamble en esta sección.



<http://go.lifetime.com/domedskylight>

6.1

- Remove any excess plastic from the holes.
- Enlevez de l'excès de plastique des trous.
- Retire cualquier plástico en exceso de los agujeros.

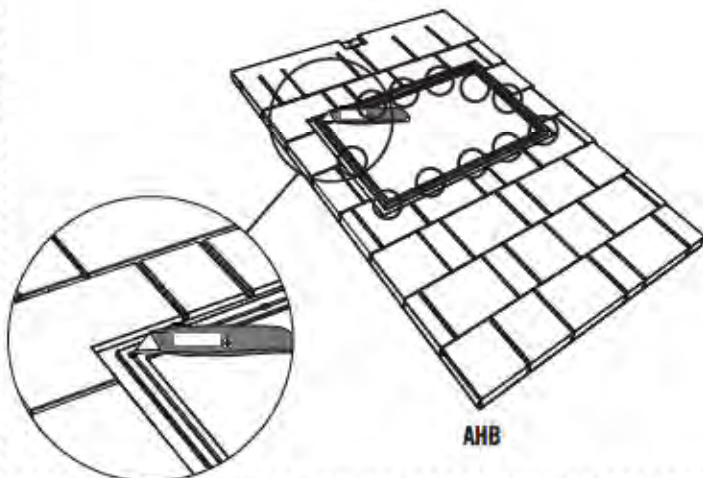

6.2

- Lay the **Butyl Tape (AHI)** over the groove along the top edge of the opening in the Roof Panel, and cut it. Peel back the paper backing a bit, and continue laying the Butyl Tape along the groove being sure to slightly overlap the ends. Continue this process until the groove around the opening is covered.
- Mettez le **ruban butyl (AHI)** sur la rainure le long du bord supérieur de l'ouverture du panneau de toit, et coupez-le. Retirez un peu le papier de protection, et continuez de mettre le ruban butyl le long de la rainure. Continuez ce processus jusqu'à ce que la rainure autour de l'ouverture soit couverte.
- Coloque la **cinta butílica (AHI)** sobre la ranura a lo largo del borde superior de la abertura del panel de techo, y córtela. Retire el papel protector un poco, y continúe colocar la cinta butílica a lo largo de la ranura asegurando de solaparse los extremos. Continúe este proceso hasta que se cubra la ranura alrededor la abertura.

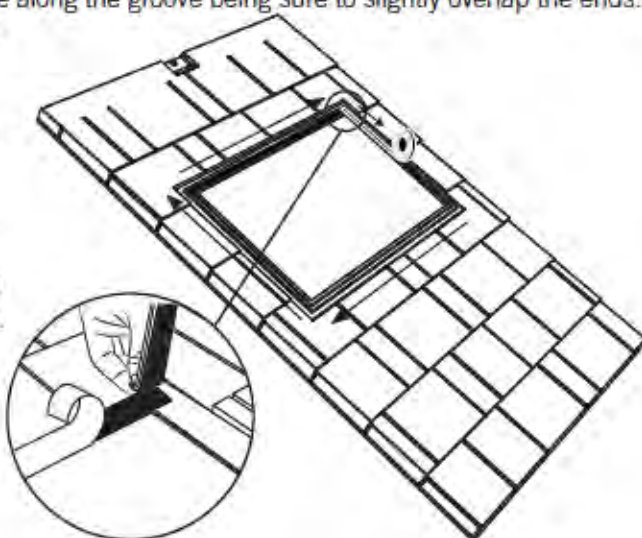

► SECTION 6 (CONTINUED) / SECTION 6 (SUITE) / SECCIÓN 6 (CONTINUACIÓN)

TOOLS AND HARDWARE REQUIRED / OUTILS ET QUINCAILLERIE REQUIS / INSTRUMENTAL Y HERRAJE REQUERIDOS



6.3

- Run your thumb along the Butyl Tape to remove any bubbles. Then, completely remove the paper backing.
- Mettez la pouce le long du ruban butylique pour éliminer des bulles. Ensuite, retirez complètement le papier de protection.
- Con el pulgar, presione a lo largo de la cinta butílica para eliminar cualquier burbuja. Entonces, retire por completo el papel protector.

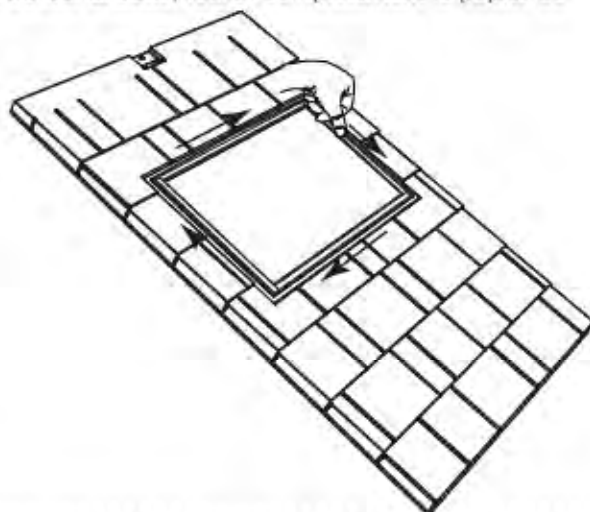

6.4

- Using a plain screwdriver, poke holes through the Butyl Tape and through the holes in the Roof Panel.
- Mettez un tournevis plat dans le ruban butylique et à travers les trous carrés dans le panneau de toit.
- Mete un destornillador de punta plana a través de la cinta butilo y los agujeros cuadrados en el panel de tejado.

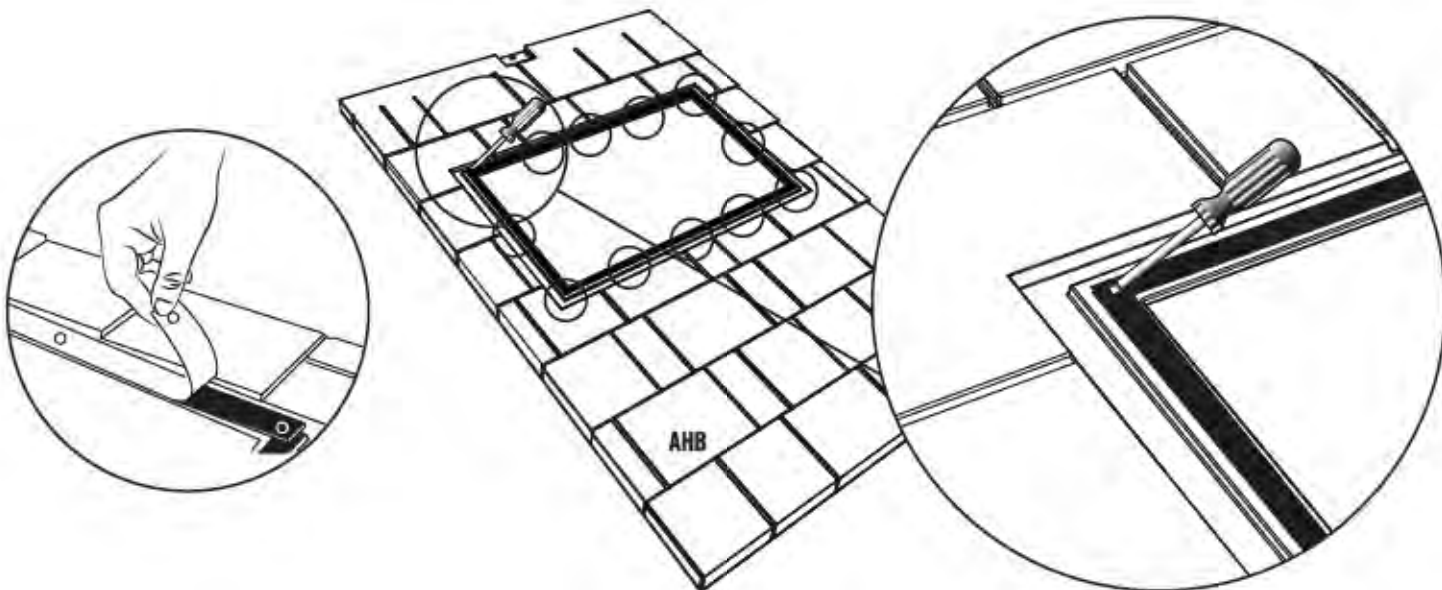

► SECTION 6 (CONTINUED) / SECTION 6 (SUITE) / SECCIÓN 6 (CONTINUACIÓN)

TOOLS AND HARDWARE REQUIRED / OUTILS ET QUINCAILLERIE REQUIS / INSTRUMENTAL Y HERRAJE REQUERIDOS



3/8 in/po
(10 mm)



EFA (x24)



ADK (x24)



AEE (x48)

6.5

- Remove the protective plastic from both sides of the **Skylight (AGB)**. Align the holes in the Domed Skylight with those in the Roof Panel, and insert the **Screws (EFA)**.
- Retirez la pellicule protectrice des deux côtés de la **lucarne (AGB)**. Alineez les trous dans la lucarne avec ceux du panneau de toit, et insérez les **vis (EFA)**.
- Retire el protector de plástico de las dos caras del **tragaluz (AGB)**. Alinee los agujeros en el tragaluz con los del panel de tejado, e inserte los **tornillos (EFA)**.

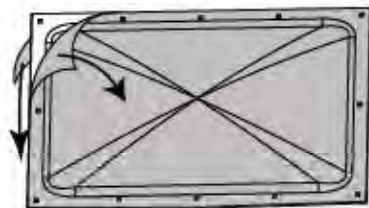

AGB

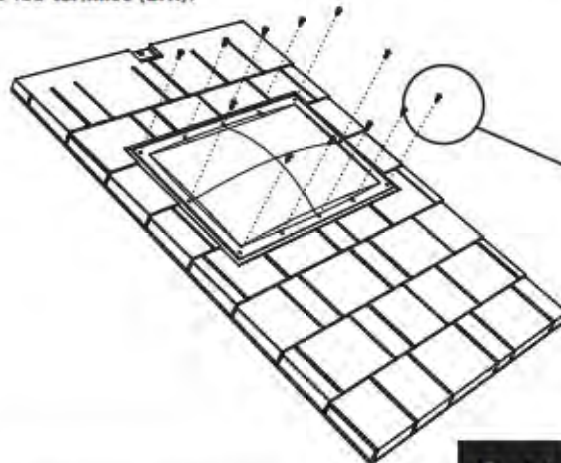

EFA

6.6

- Secure the Skylight using the hardware provided. **Do not overtighten.**
- Attachez bien la lucarne à l'aide de la quincaillerie incluse. **Ne pas trop serrer.**
- Sujete el tragaluz usando el herraje incluido. **No apriete demasiado.**

6.7

- Repeat this section for the second Skylight.
- Répétez cette section pour la deuxième lucarne.
- Repita esta sección para el segundo tragaluz.

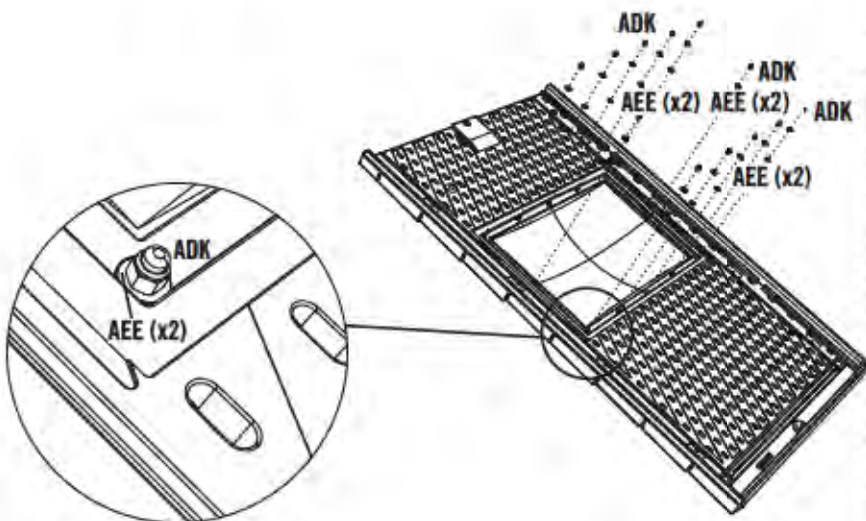

AEE (x2)

ADK

ADK

ADK

AEE (x2)

AEE (x2)

AEE (x2)

ADK

AEE (x2)

AEE (x2)

AEE (x2)

AEE (x2)

AEE (x2)

7

FLOOR ASSEMBLY / ASSEMBLAGE DU PLANCHER / ENSAMBLE DEL PISO



HARDWARE REQUIRED / QUINCAILLERIE REQUISE / HERRAJE REQUERIDO

Hardware Bag / Sac de quincaillerie / Bolsa de herraje



BQC (x30)



AHO (x4)

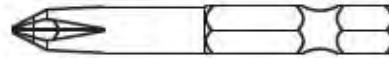

ADC (x1)



*Note: These are not anchoring screws. Their purpose is to fasten together the Floor Panels.
Remarque : Ces vis ne sont pas de vis d'ancrage. Leur but est pour attacher les panneaux de plancher.
Nota: Estos no son tornillos de anclaje. Son propósito es sólo para unir los paneles de piso.*



PARTS REQUIRED / PIÈCES REQUISES / PIEZAS REQUERIDAS

Plastic Parts / Pièces en plastique / Piezas de plástico

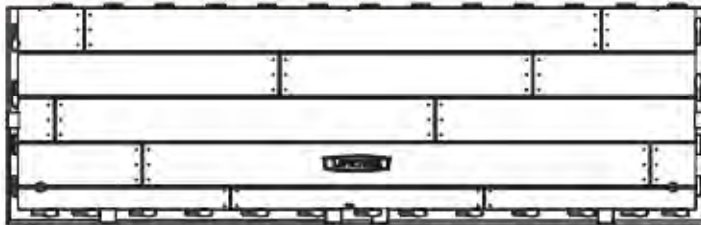

CUW (x2)

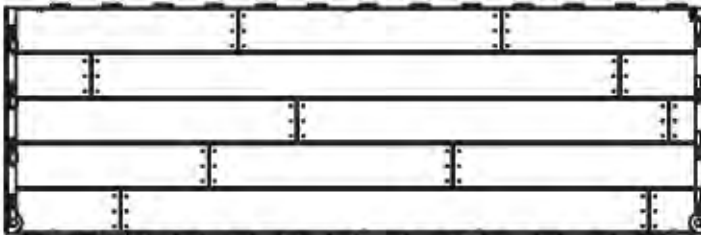

CUD (x4)



TOOLS REQUIRED / OUTILS REQUIS / INSTRUMENTAL REQUERIDO



► SECTION 7 (CONTINUED) / SECTION 7 (SUITE) / SECCIÓN 7 (CONTINUACIÓN)

TOOLS AND HARDWARE REQUIRED / OUTILS ET QUINCAILLERIE REQUIS / INSTRUMENTAL Y HERRAJE REQUERIDOS



7.1



- Hold an **Inner Floor Panel (CUD)** at an angle and slide the tabs along the edge underneath an **Outer Floor Panel (CUW)**. The tabs interlock. Lay Panel down flat.
- Posez un **panneau de plancher intérieur (CUD)** à un angle et glissez les languettes le long du bord au-dessus du **panneau de plancher extérieur (CUW)**. Les languettes s'enclenchent les uns les autres. Étendez-le par terre.
- Coloque un **panel de piso interior (CUD)** a un ángulo y deslice las lengüetas a lo largo del borde debajo el **panel de piso exterior (CUW)**. Las lengüetas se entrelazarán las unas con las otras. Aplane el panel.

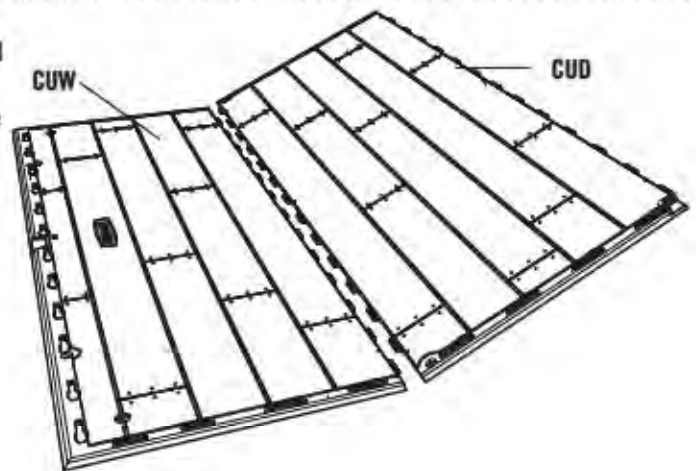

7.2

- Repeat the last step. If the hole is not at this corner, turn the Panel 180°.
- Répétez la dernière étape. Si le trou n'est pas ici, tournez le panneau 180°.
- Repita el último paso. Si el agujero no está aquí, gire el panel 180°.

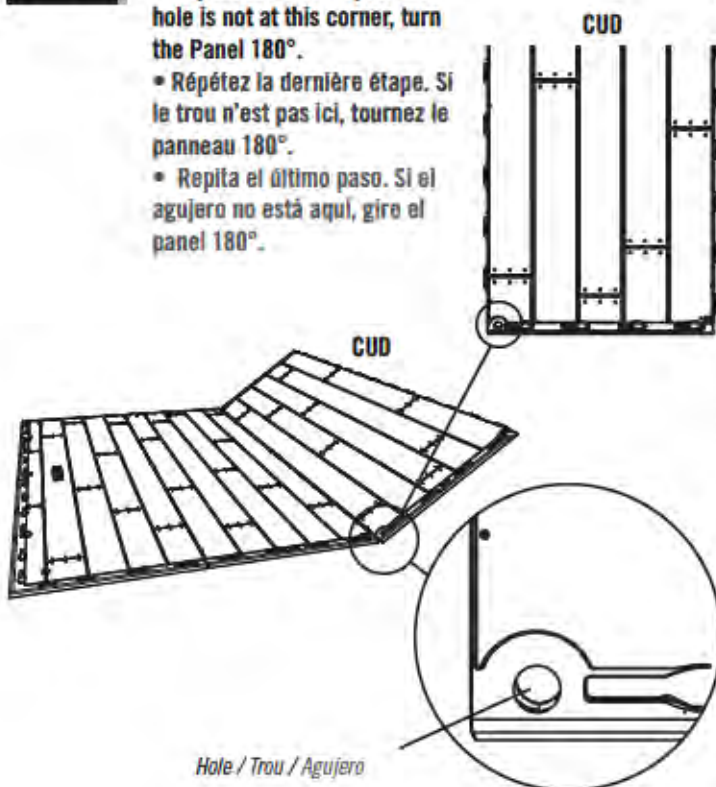

7.3

- Repeat the last step. If the hole is not at this corner, turn the Panel 180°.
- Répétez la dernière étape. Si le trou n'est pas ici, tournez le panneau 180°.
- Repita el último paso. Si el agujero no está aquí, gire el panel 180°.

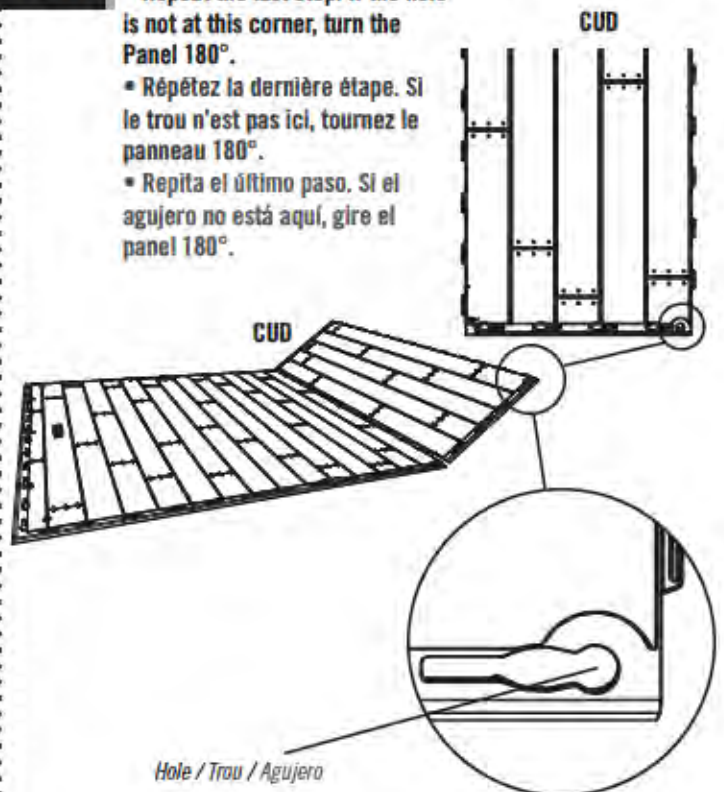

► SECTION 7 (CONTINUED) / SECTION 7 (SUITE) / SECCIÓN 7 (CONTINUACIÓN)

TOOLS AND HARDWARE REQUIRED / OUTILS ET QUINCAILLERIE REQUIS / INSTRUMENTAL Y HERRAJE REQUERIDOS



AHO (x4)

7.4

- Repeat the last step.
- Répétez l'étape précédente.
- Repita el paso anterior.

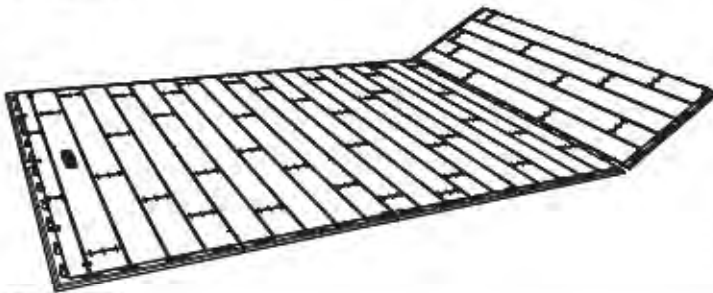

7.5

- Attach an **Outer Floor Panel (CUW)** to the Inner Floor Panel.
- Attachez un autre **panneau de plancher intérieur (CUW)** au panneau de plancher intérieur.
- Fije otro **panel de piso exterior (CUW)** al panel de piso interior.



7.6

- Decide on which ends you would like to install your Doors. Insert **Bushings (AHO)** through the holes in the Floor. **The slit in the Bushing should face away from the Floor.**
- Choisissez l'extrémité où vous désireriez installer les portes. Insérez les **bagues (AHO)** à travers les trous dans le plancher. **La fente dans la bague ne doit pas faire face au plancher.**
- Escoja los bordes en los cuales le gustaría instalar las puertas. Introduzca los **casquillos (AHO)** a través de los agujeros en el piso. **La rendija en el casquillo debe quedar en posición opuesta del piso.**



Note: The Doors on the end may be placed on either end.
Remarque : Vous pouvez installer les portes dans l'extrémité droite ou gauche.
Nota: Se pueden instalar las puertas en el extremo derecho o izquierdo.

► SECTION 7 (CONTINUED) / SECTION 7 (SUITE) / SECCIÓN 7 (CONTINUACIÓN)

TOOLS AND HARDWARE REQUIRED / OUTILS ET QUINCAILLERIE REQUIS / INSTRUMENTAL Y HERRAJE REQUERIDOS



BQC (x30)

7.7

- Insert the **Screws (BQC)** through the divots in the Floor Panels and into the tabs of the adjacent Floor Panels. (The divots are near the seams of the Floor Panels.)
- Insérez les **vis (BQC)** à travers les marques dans les panneaux de plancher et dans les languettes du panneaux de plancher contigu. (Les marques se trouvent près des jonctions des panneaux de plancher.)
- Introduzca los **tornillos (BQC)** a través de las marcas en los paneles de piso y dentro de las lengüetas de los paneles de piso adyacentes. (Se encuentran las marcas cerca de las juntas de los Paneles de piso.)

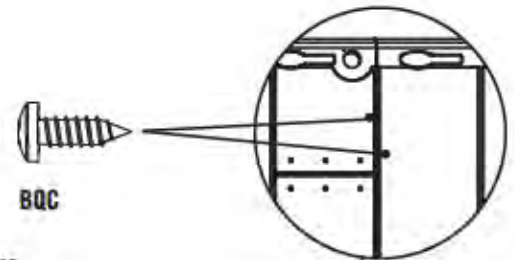

*Note: These are not anchoring screws. Their purpose is to fasten together the Floor Panels.
Remarque : Ces vis ne sont pas de vis d'ancrage. Leur but est pour attacher les panneaux de plancher.
Nota: Estos no son tornillos de anclaje. Son propósito es sólo para unir los paneles de piso.*

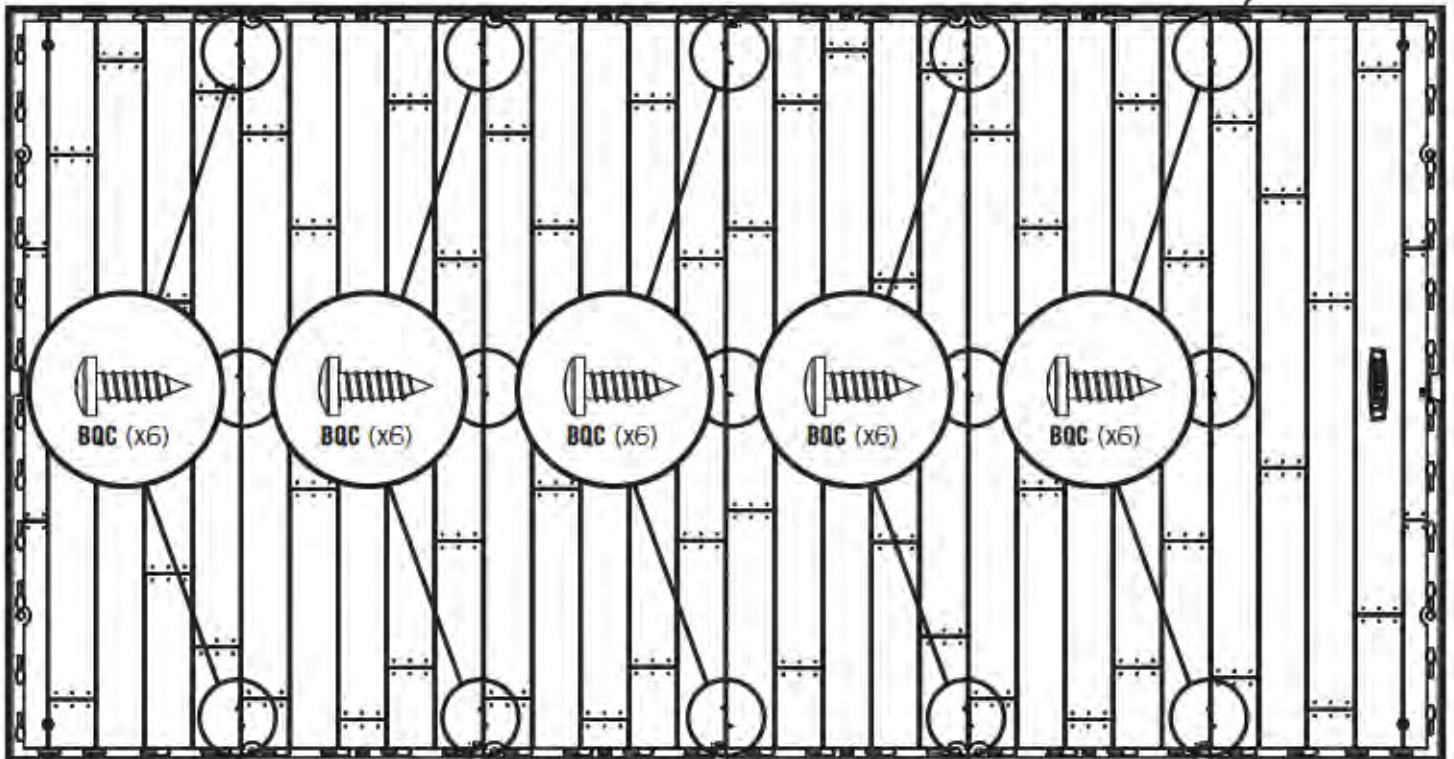

8

WALL ASSEMBLY / ASSEMBLAGE DES MURS / ENSAMBLE DE LOS MUROS



HARDWARE REQUIRED / QUINCAILLERIE REQUISE / HERRAJE REQUERIDO

Hardware Bag / Sac de quincaillerie / Bolsa de herraje

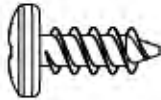

ADZ (x85)



PARTS REQUIRED / PIÈCES REQUISES / PIEZAS REQUERIDAS

Metal Parts / Pièces en métal / Piezas de metal



AFM (x2)

Plastic Parts / Pièces en plastique / Piezas de plástico

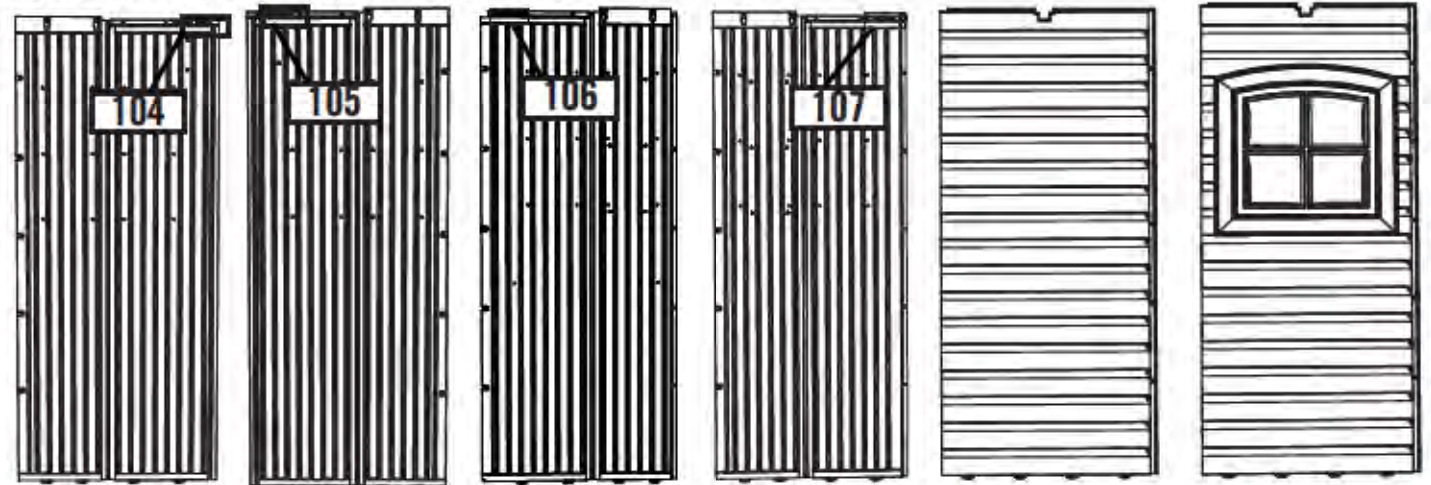

AGY (x1) AGN (x1) AGW (x1) AGL (x1) AHD (x7) AHH (x2)

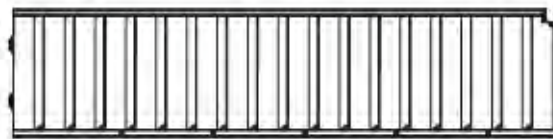

CKN (x1)

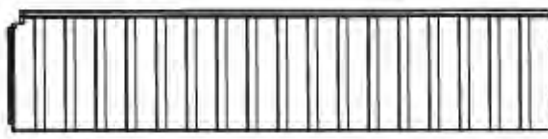

CKK (x1)



TOOLS REQUIRED / OUTILS REQUIS / INSTRUMENTAL REQUERIDO



AIW (x1)



► SECTION 8 (CONTINUED) / SECTION 8 (SUITE) / SECCIÓN 8 (CONTINUACIÓN)

TOOLS AND HARDWARE REQUIRED / OUTILS ET QUINCAILLERIE REQUIS / INSTRUMENTAL Y HERRAJE REQUERIDOS



AIW (x1)

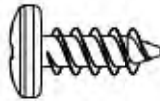

ADZ (x5)

8.1



- Insert tabs at the bottom of the **Right Half-Wall Panel (CKN)** into the seventh and eighth slots from the front, right corner of the Floor.
- Insérez les languettes au bord inférieur du **panneau étroit droit (CKN)** dans les septième et huitième rainures du coin droit du plancher.
- Introduzca las lengüetas al borde inferior del **panel angosto derecho (CKN)** en las séptima y octava ranuras de la esquina derecha del piso.



CKN

CKN

8.2

- Slide the Panel to the left.
- Faites glisser le panneau à gauche.
- Deslice el panel a la izquierda.

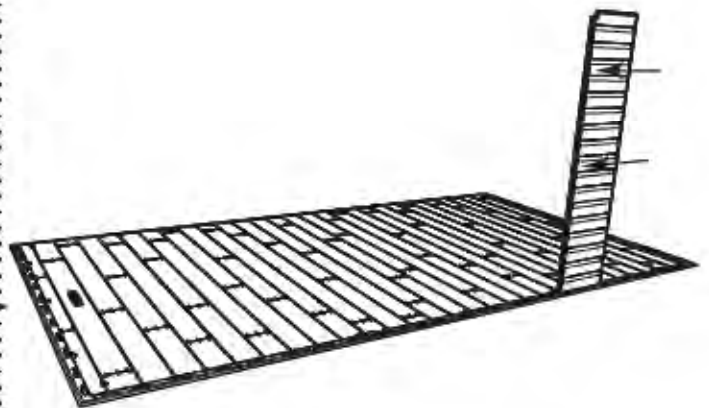

8.3



- Insert the **Window Wall Panel (AHH)** into the next four slots, and slide the Panel to the left. Secure the two Panels together with five **Screws (ADZ)**.
- Insérez le **panneau pour la fenêtre (AHH)** dans les quatre rainures suivantes, et faites glisser le panneau à gauche. Attachez bien les panneaux à l'aide de cinq (5) vis (ADZ).
- Inserte el **Panel para la ventana (AHH)** en las próximas cuatro ranuras, y deslice el Panel a la izquierda. Sujete los paneles usando cinco (5) tornillos (ADZ).

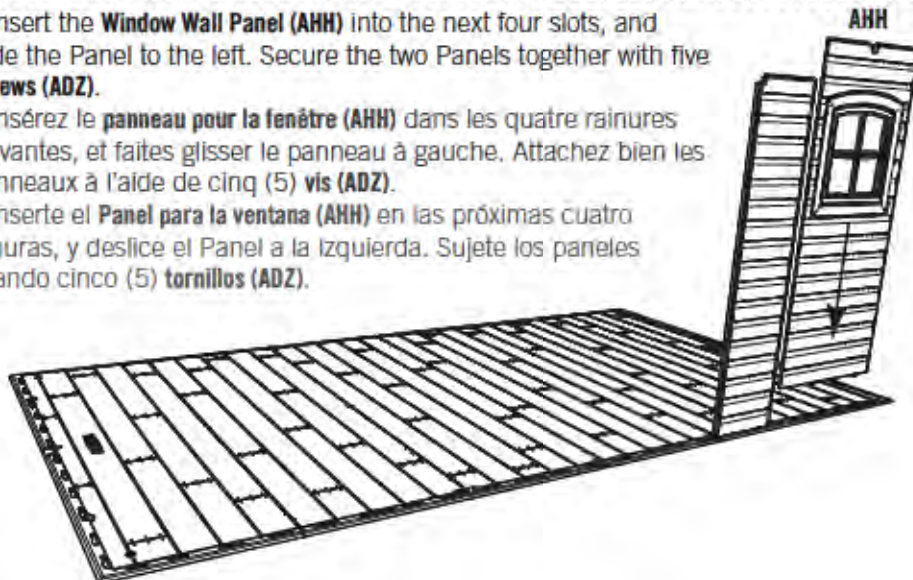

AHH

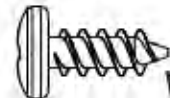

► SECTION 8 (CONTINUED) / SECTION 8 (SUITE) / SECCIÓN 8 (CONTINUACIÓN)

TOOLS AND HARDWARE REQUIRED / OUTILS ET QUINCAILLERIE REQUIS / INSTRUMENTAL Y HERRAJE REQUERIDOS



AIW (x1)

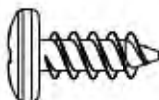

ADZ (x5)



• You may install the Side Doors on either end; however, you will need to install the Corner Panels (AGN & ANY) on the same end as you do the Doors.

• Vous pouvez installer les portes latérales dans le côté droit ou le côté gauche; néanmoins, il faut installer les panneaux angulaires (AGN et AGY) dans le même côté que les portes.

• Se pueden instalar las puertas laterales en el lado derecho o izquierdo; sin embargo, es preciso instalar los paneles angulares (AGN y AGY) en el mismo lado que las puertas.

8.4

• Insert tabs at the bottom of the **Corner Panel (AGN)** into the first two slots along the right edge of the Floor. Slide the Panel toward the front of the Floor.

• Insérez les languettes au bord inférieur du **panneau angulaire (AGN)** dans les premières rainures le long du bord droit du plancher. Glissez le panneau vers la partie avant de l'abri.

• Introduzca las lengüetas al borde inferior del **panel angular (AGN)** en las primeras dos ranuras a lo largo del borde derecho del piso. Deslice el panel hacia la parte delantera de la caseta.



8.5

• Bend the Corner Panel as shown, and pull down to snap the tabs into the first two slots from the right corner of the Floor. Place the **Wood Block (AIW)** underneath the Floor and directly underneath the tab being inserted to help with insertion. Secure with five (5) **Screws (ADZ)**.

• Pliez le panneau angulaire comme illustré, tirez le panneau vers le bas, et insérez les languettes dans les premières deux encoches du coin avant droit. Pour aider avec l'insertion, mettez le **bloc en bois (AIW)** sous le plancher et directement sous la languette que vous voulez insérer. Secure with five (5) **screws (ADZ)**.

• Pliegue el panel angular como se muestra, tire para abajo el panel, e introduzca las lengüetas en las dos primeras muescas de la esquina delantera derecha. Para ayudar con la inserción, coloque el **bloque de madera (AIW)** debajo el piso y directamente debajo la lengüeta que quiere insertar. Sujételos con cinco (5) **tornillos (ADZ)**.



► SECTION 8 (CONTINUED) / SECTION 8 (SUITE) / SECCIÓN 8 (CONTINUACIÓN)

TOOLS AND HARDWARE REQUIRED / OUTILS ET QUINCAILLERIE REQUIS / INSTRUMENTAL Y HERRAJE REQUERIDOS



AIW (x1)

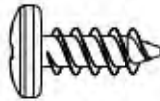

ADZ (x30)

8.6



- For the right, rear **Corner Panel (AGY)**, repeat the step you did for the right, front Corner Panel.
- Pour le **panneau angulaire (AGY)** arrière droit, répétez les étapes que vous avez réalisé pour le panneau angulaire avant droit.
- Para el **panel angular (AGY)** trasero derecho, repita los pasos que se efectuaron para el panel angular delantero derecho.

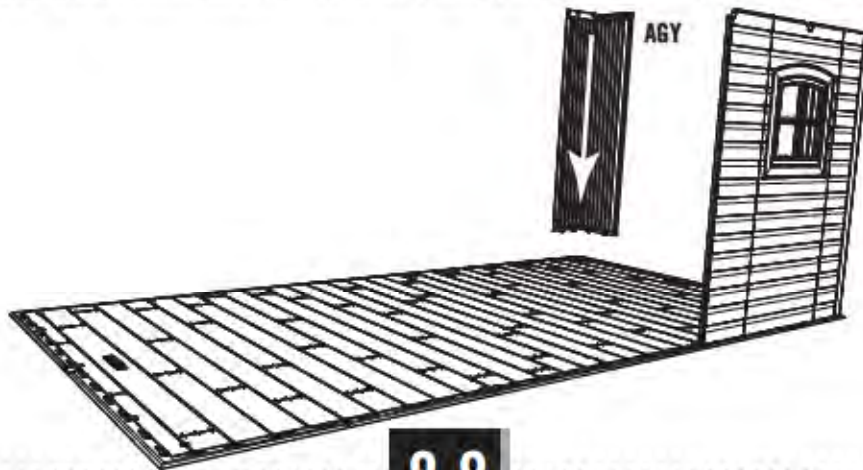

8.7



- Insert **Wall Panels (AHD)** along the rear of the Floor one at a time, and slide them to the right. **Secure with Screws (ADZ).**
- Insérez les **panneaux muraux (AHD)** le long du bord arrière du plancher un par un, et glissez-les à la droite. Attachez-les bien à l'aide des **vis (ADZ).**
- Inserte unos **paneles murales (AHD)** a lo largo del borde trasero del piso uno por uno, y deslícelos a la derecha. Sujételos los unos con los otros usando los **torillos (ADZ).**

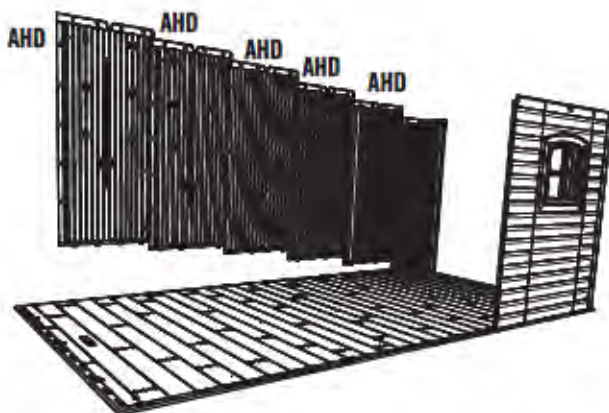

8.8



- For the left, rear **Corner Panel (AGW)**, repeat the step you did for the right, front Corner Panel.
- Pour le **panneau angulaire (AGW)** arrière gauche, répétez les étapes que vous avez réalisé pour le panneau angulaire avant droit.
- Para el **panel angular (AGW)** trasero izquierdo, repita los pasos que se efectuaron para el panel angular delantero derecho.

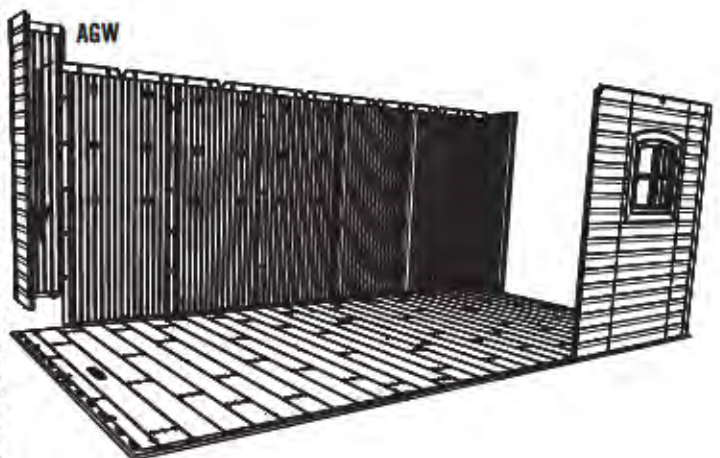

► SECTION 8 (CONTINUED) / SECTION 8 (SUITE) / SECCIÓN 8 (CONTINUACIÓN)

TOOLS AND HARDWARE REQUIRED / OUTILS ET QUINCAILLERIE REQUIS / INSTRUMENTAL Y HERRAJE REQUERIDOS



AIW (x1)

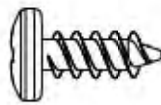

ADZ (x25)

8.9



- Insert **Wall Panels (AHD)** along the left side of the Floor one at a time, and slide them toward the rear. **Secure with Screws (ADZ).**
- Insérez les **panneaux muraux (AHD)** le long du bord gauche du plancher un par un, et glissez-les vers la partie arrière du plancher. Attachez-les bien à l'aide des **vis (ADZ).**
- Inserte los últimos **paneles murales (AHD)** a lo largo del borde izquierdo del piso uno por uno, y deslícelos hacia la parte trasera del piso. Sujételos los unos con los otros usando los **tornillos (ADZ).**

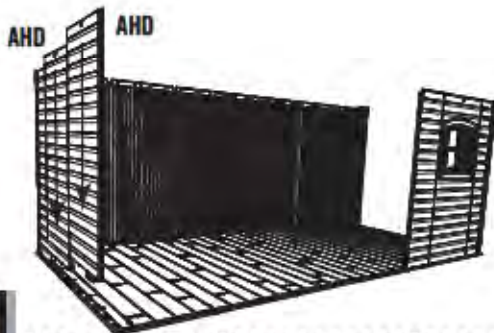

8.10



- For the left, front **Corner Panel (AGL)**, repeat the step you did for the right, front Corner Panel.
- Pour le **panneau angulaire (AGL)** avant gauche, répétez les étapes que vous avez réalisé pour le panneau angulaire avant droit.
- Para el **panel angular (AGL)** delantero izquierdo, repita los pasos que se efectuaron para el panel angular delantero derecho.

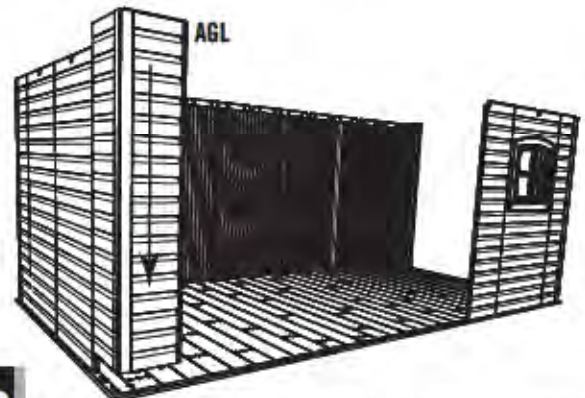

8.11



- Insert the **Window Wall Panel (AHH)** into the next four slots, and slide the Panel to the left. Secure the two Panels together with five **Screws (ADZ).**
- Insérez le **panneau pour la fenêtre (AHH)** dans les quatre rainures suivantes, et faites glisser le panneau à gauche. Attachez bien les panneaux à l'aide de cinq (5) **vis (ADZ).**
- Inserte el **panel para la ventana (AHH)** en las próximas cuatro ranuras, y deslice el panel a la izquierda. Sujete los paneles usando cinco (5) **tornillos (ADZ).**



8.12



- Insert the **Left Half-Wall Panel (CKK)**, slide it to the left, and secure with **Screws (ADZ).**
- Insérez le **panneau étroit gauche (CKK)**, glissez-le à gauche, et attachez-le à l'aide des **vis (ADZ).**
- Introduzca el **panel izquierdo angosto (CKK)**, deslícelo a la izquierda, y sujételo usando **tornillos (ADZ).**

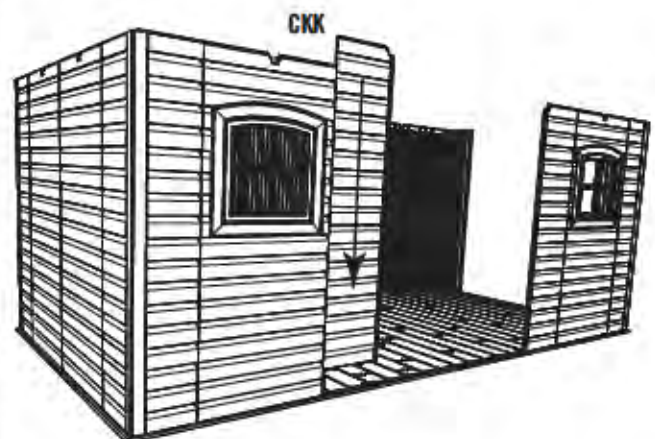

► SECTION 8 (CONTINUED) / SECTION 8 (SUITE) / SECCIÓN 8 (CONTINUACIÓN)

TOOLS AND HARDWARE REQUIRED / OUTILS ET QUINCAILLERIE REQUIS / INSTRUMENTAL Y HERRAJE REQUERIDOS

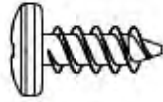

ADZ (x4)

8.13

- Four (4) **Screws (ADZ)** are used to attach the **Channel (AFM)**.
- Quatre (4) **vis (ADZ)** servent pour attacher le **support (AFM)** au panneau mural.
- Se usan cuatro (4) **tornillos (ADZ)** por sujetar el **canal (AFM)** al panel de pared.



Nota: The top hole does not use a Screw.

Remarque : Ne pas insérer une vis à travers le trou supérieur.

Nota: El agujero superior no se usa un tornillo.

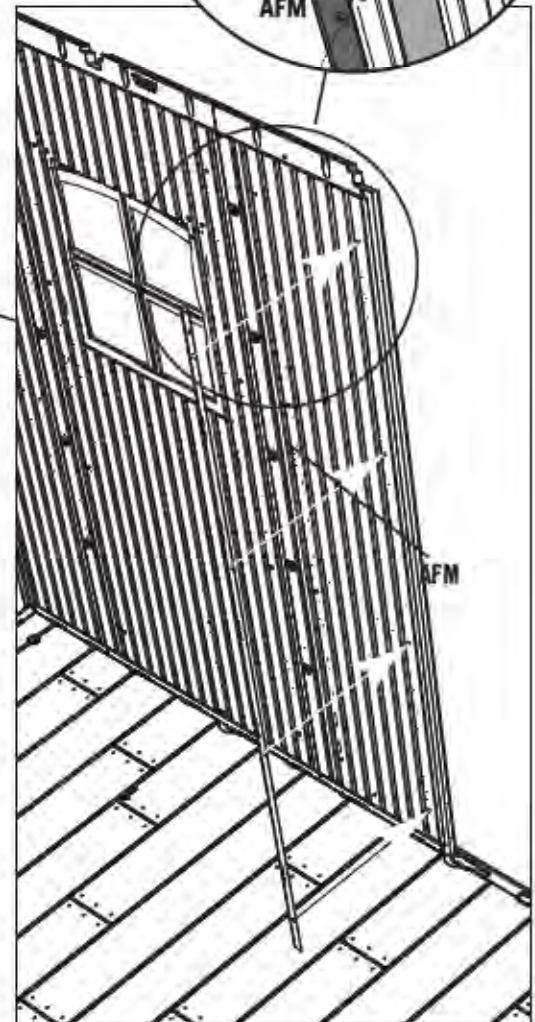
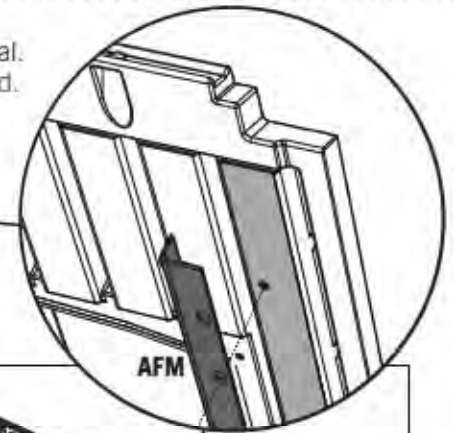
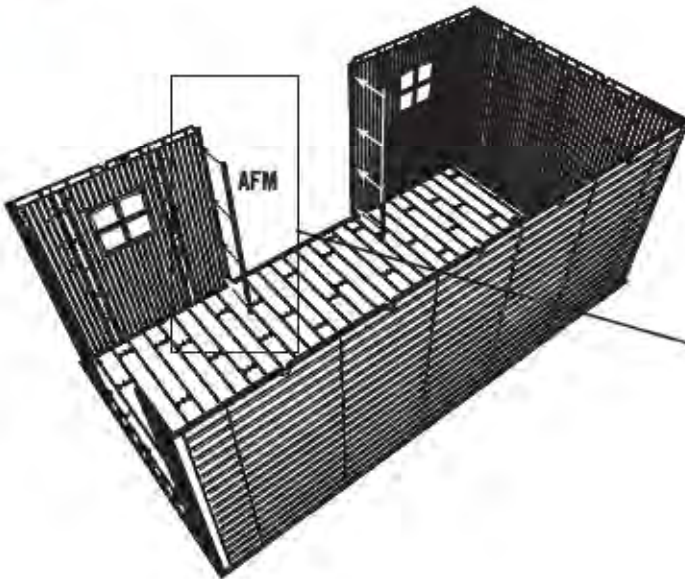

► SECTION 8 (CONTINUED) / SECTION 8 (SUITE) / SECCIÓN 8 (CONTINUACIÓN)

TOOLS AND HARDWARE REQUIRED / OUTILS ET QUINCAILLERIE REQUIS / INSTRUMENTAL Y HERRAJE REQUERIDOS

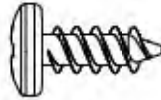

ADZ (x4)

8.14

- Four (4) **Screws (ADZ)** are used to attach the **Channel (AFM)** to the Wall Panel.
The top hole does not use a Screw.
- Quatre (4) **vis (ADZ)** servent pour attacher le **support (AFM)** au panneau mural.
Ne pas insérer une vis à travers le trou supérieur.
- Se usan cuatro (4) **tornillos (ADZ)** para sujetar el **canal (AFM)** al panel de pared.
No inserte un tornillo en el agujero superior.



Nota: The top hole does not use a Screw.

Remarque: Ne pas insérer une vis à travers le trou supérieur.

Nota: El agujero superior no se usa un tornillo.

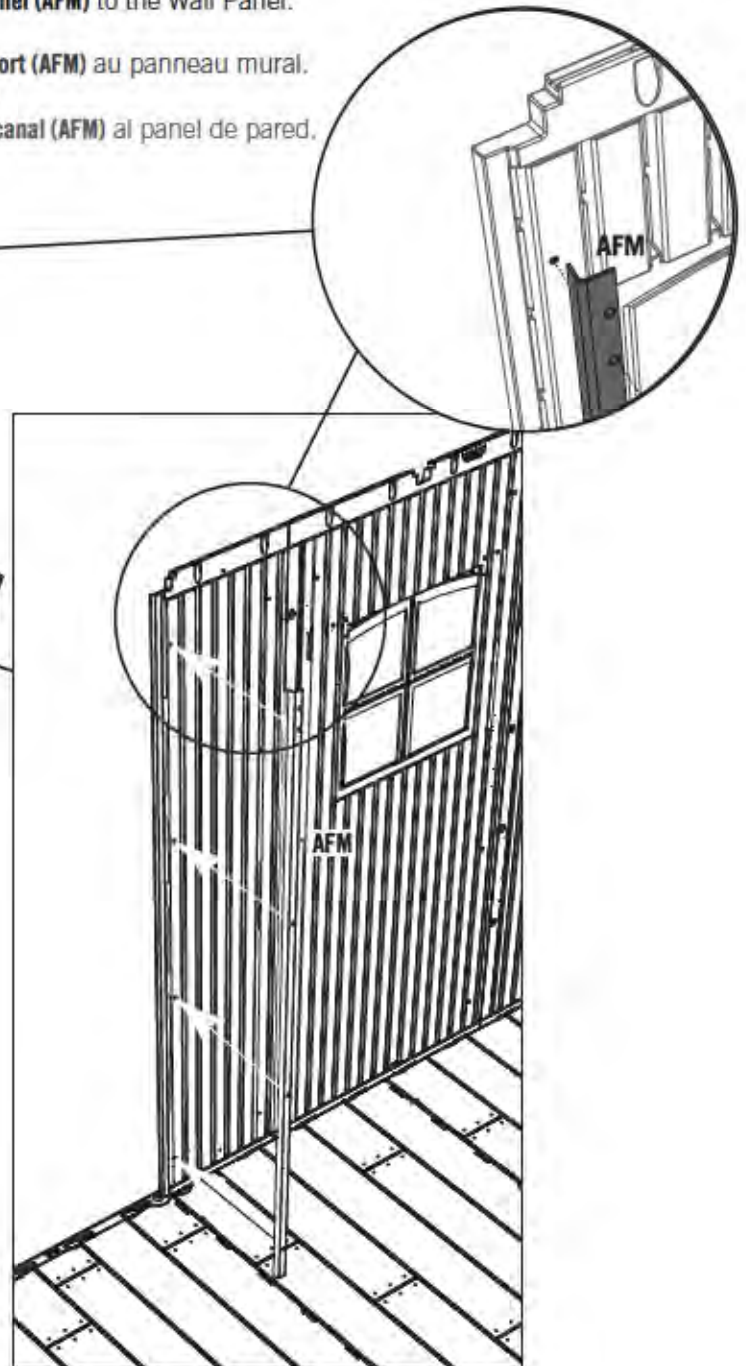
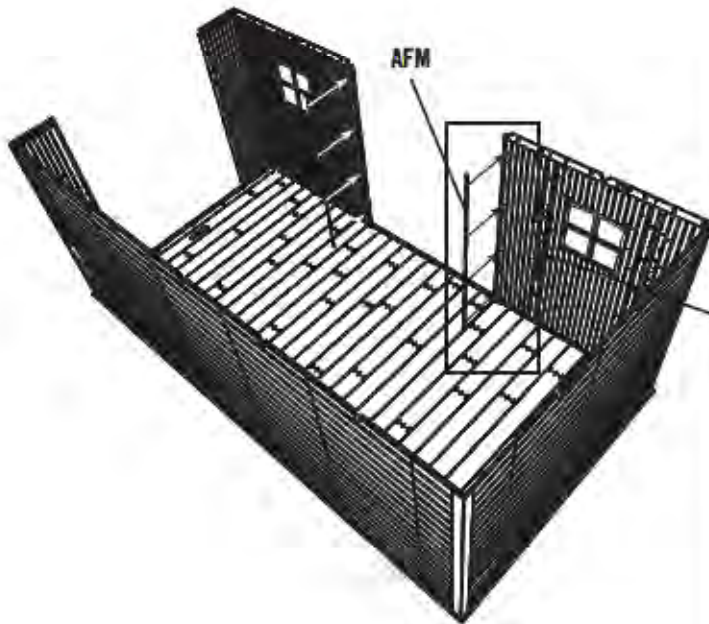



HARDWARE REQUIRED / QUINCAILLERIE REQUISE / HERRAJE REQUERIDO

Hardware Bag / Sac de quincaillerie / Bolsa de herraje

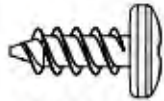

ADZ (x14)



AIY (x2)

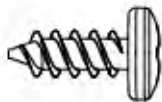

ADZ (x16)



PARTS REQUIRED / PIÈCES REQUISES / PIEZAS REQUERIDAS

Metal Parts / Pièces en métal / Piezas de metal

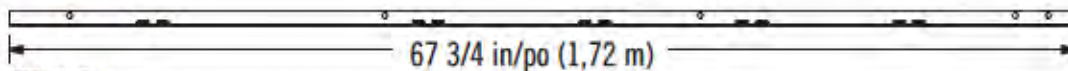

AFM (x2)



Plastic Parts / Pièces en plastique / Piezas de plástico



AFV (x1)



AFZ (x4)



TOOLS REQUIRED / OUTILS REQUIS / INSTRUMENTAL REQUERIDO



► SECTION 9 (CONTINUED) / SECTION 9 (SUITE) / SECCIÓN 9 (CONTINUACIÓN)

TOOLS AND HARDWARE REQUIRED / OUTILS ET QUINCAILLERIE REQUIS / INSTRUMENTAL Y HERRAJE REQUERIDOS

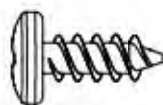

ADZ (x8)



• If you have trouble with this section, follow the code below to view a video on the assembly in this section.

• Si vous avez des problèmes avec cette section, suivez le code en bas pour voir un vidéo sur l'assemblage dans cette section.

• Si tiene problemas con esta sección, siga el código debajo para ver un video sobre el ensamble en esta sección.

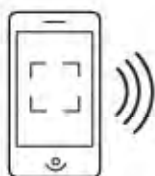

<http://go.lifetime.com/90shelf>

9.1

• The right **Wall/Shelf Support Channel (AFM)** goes in the slot directly under the notch in the Wall Panel. The left Wall Support Channel goes in the slot to the right of the notch in the Wall Panel.

• Le **canal de support du mur/étagère (AFM)** droit s'attache dans la rainure directement sous l'encoche dans le panneau mural. Le canal de support du mur/étagère gauche s'attache dans la rainure à la droite de l'encoche du panneau mural.

• El **canal de soporte para la pared/estante (AFM)** derecho se sujeta dentro de la ranura directamente debajo la muesca en el panel de pared. El canal de soporte para la pared izquierdo se sujeta dentro de la ranura a la derecha de la muesca en el panel de pared.

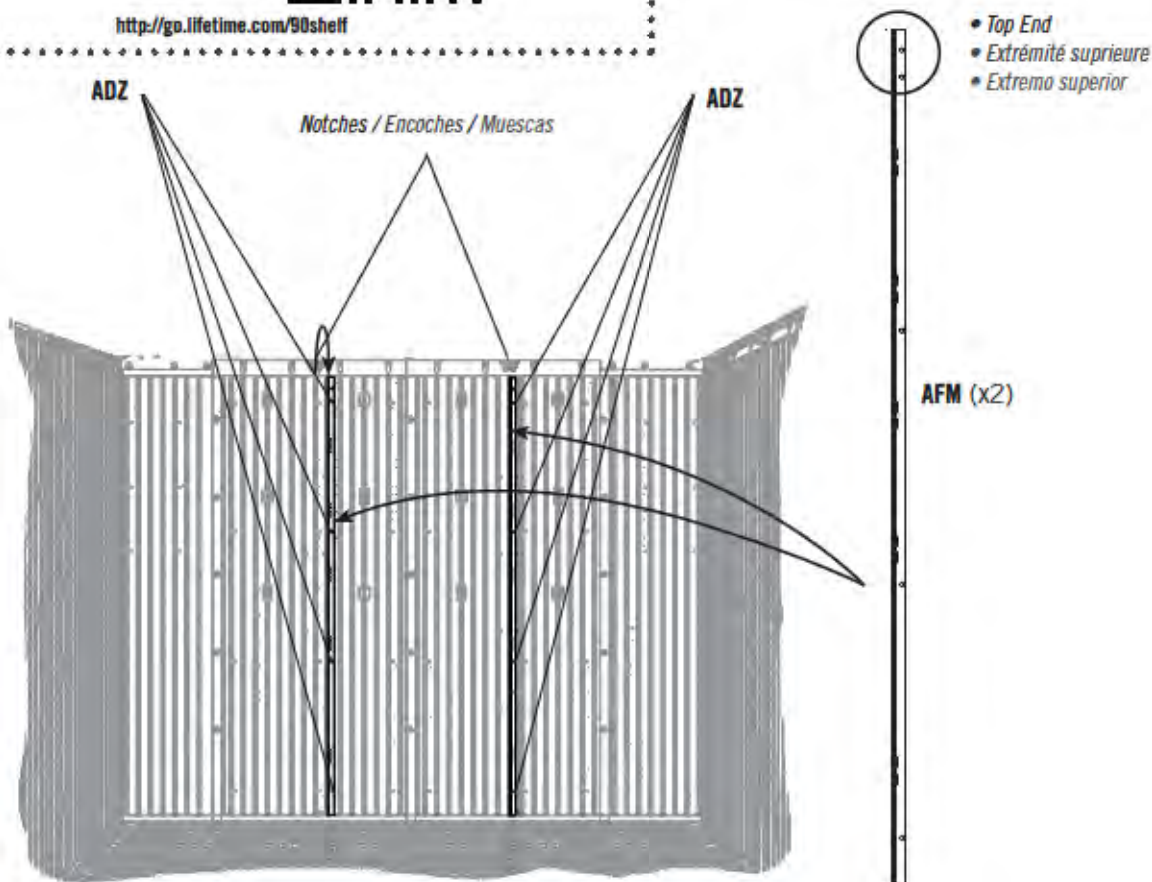



PARTS IDENTIFIER / IDENTIFICATEUR DE PIÈCES / IDENTIFICADOR DE PIEZAS

CONTENTS OF BOX 1 / CONTENU DE LA BOÎTE 1 / CONTENIDO DE LA CAJA 1



AGO (x1)

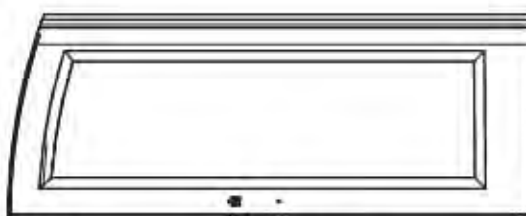

AGZ (x1)

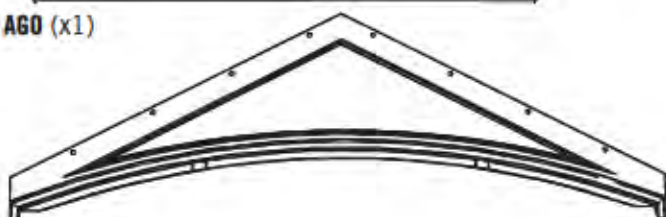

BDC (x1)

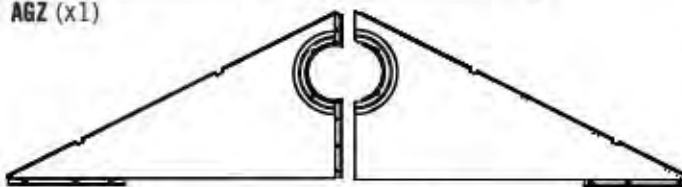

AGH (x1)

AGI (x1)

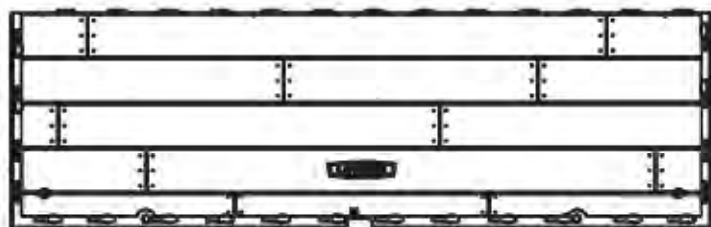

CUW (x2)

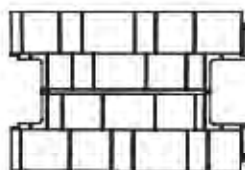

AFY (x3)

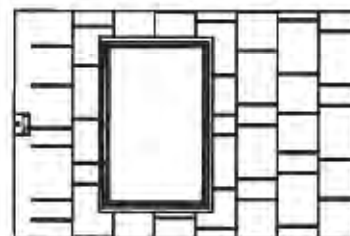

AHB (x2)

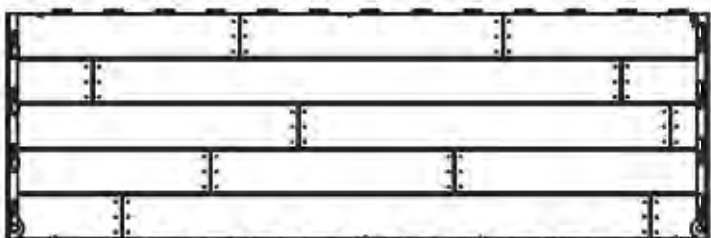

CUD (x2)



AGF (x1)

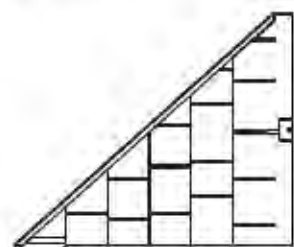

BDR (x1)

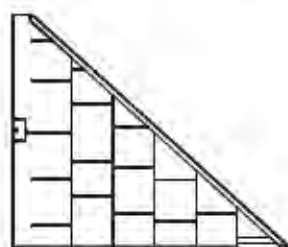

BDS (x1)



AFV (x1)

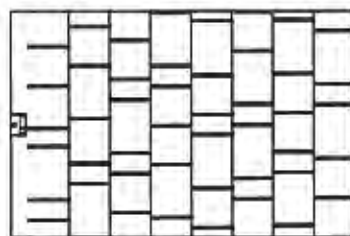

AGQ (x4)



DRA (x1)

Remove This Section / Enlevez cette section / Retire esta sección



PARTS IDENTIFIER / IDENTIFICATEUR DE PIÈCES / IDENTIFICADOR DE PIEZAS

METAL PARTS KIT 1 / KIT PIÈCES EN MÉTAL 1 / KIT DE PIEZAS DE METAL 1

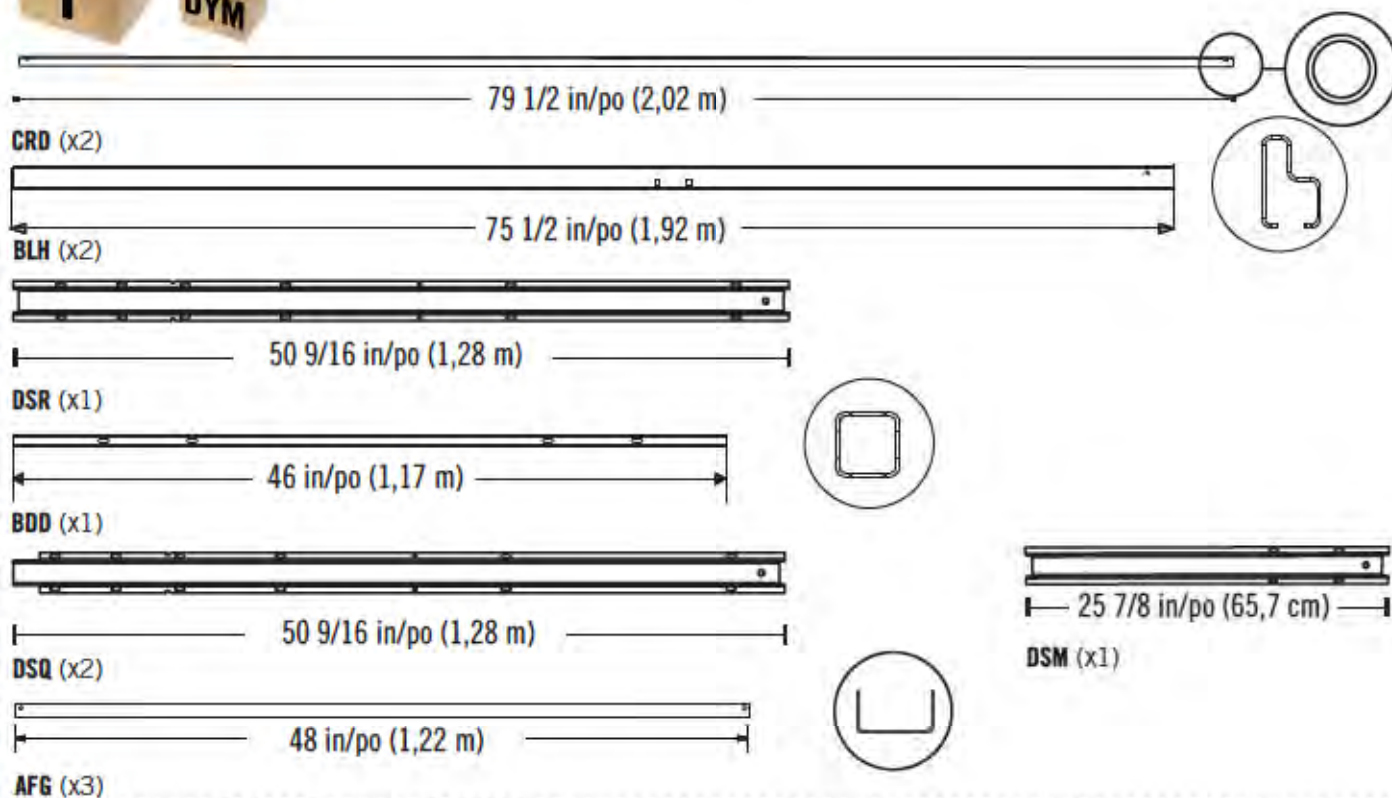

Remove This Section / Enlevez cette section / Retire esta sección

METAL PARTS KIT 2 / KIT PIÈCES EN MÉTAL 2 / KIT DE PIEZAS DE METAL 2

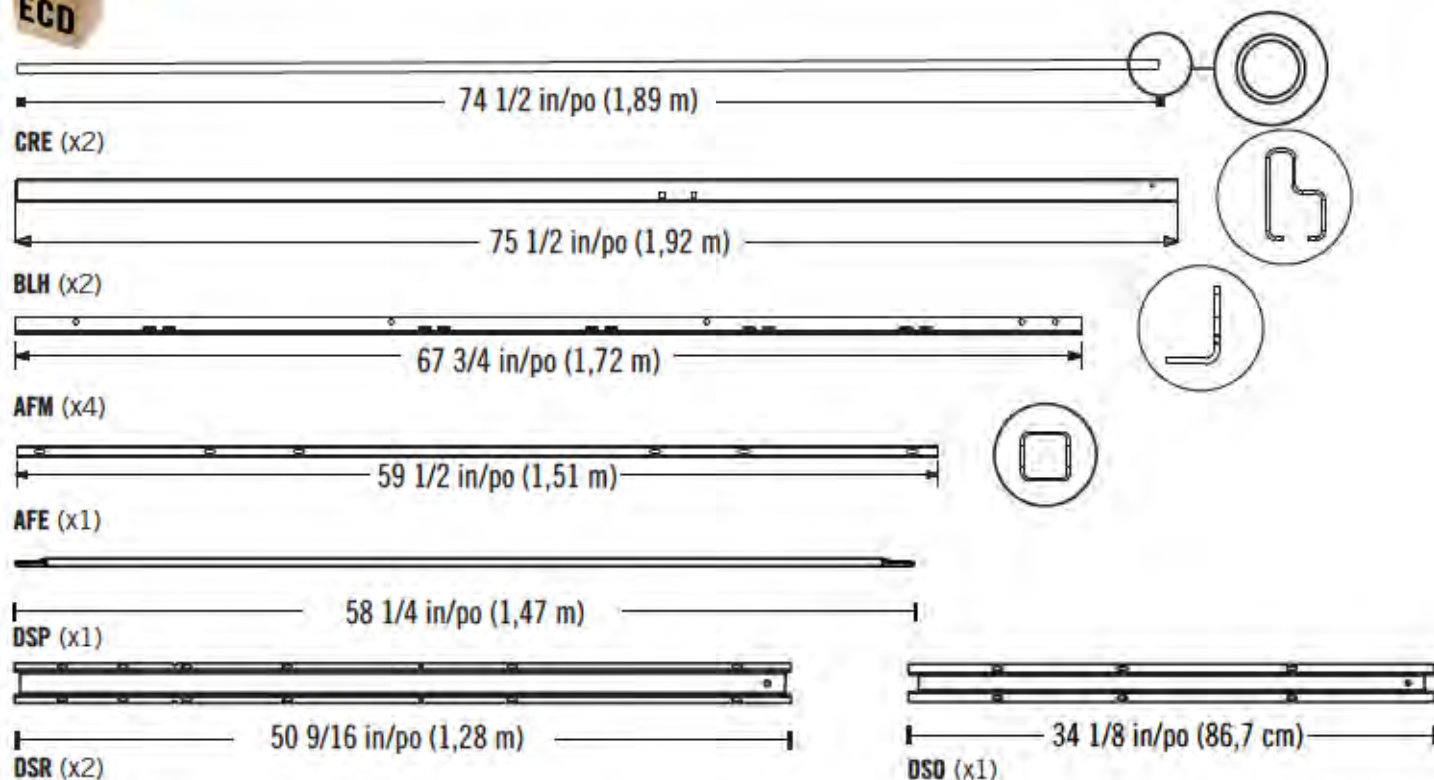



PARTS IDENTIFIER / IDENTIFICATEUR DE PIÈCES / IDENTIFICADOR DE PIEZAS

CONTENTS OF BOX 2 / CONTENU DE LA BOÎTE 2 / CONTENIDO DE LA CAJA 2



BDI (x1)

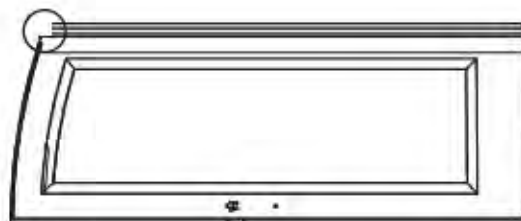

BDK (x1)



AGY (x1)

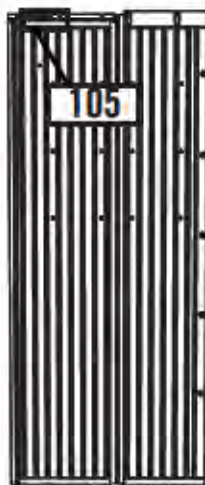

AGN (x1)

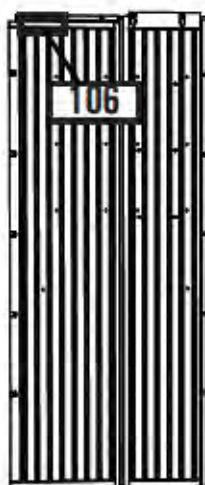

AGW (x1)



AGL (x1)



AHH (x2)



AHD (x3)

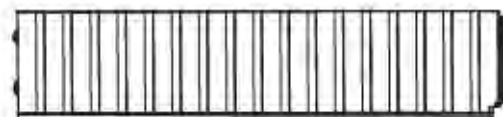

CKK (x1)



CKN (x1)

CONTENTS OF SMALL PARTS BOX / CONTENU DE LA BOÎTE DE PETITES PIÈCES / CONTENIDO DE LA CAJA DE PIEZAS PEQUEÑAS

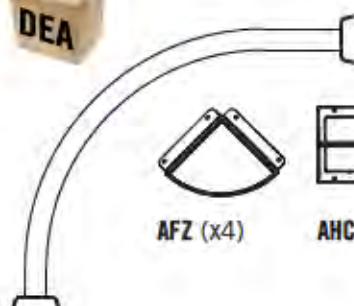

AYG (x1)



AFZ (x4)



AHC (x6)



AHE (x2)



AFL (x12)



AIP (x5)

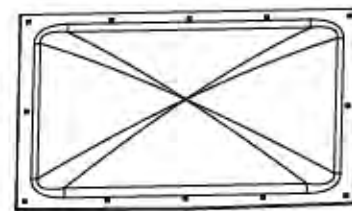

AGB (x2)



AIW (x1)



AIX (x4)



AGG (x1)



AFW (x1)



AYI (x4)

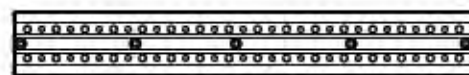

AFU (x2)



± 8 7/16 in/po (21,4 cm) ±

DSN (x1)



DRB (x1)

Remove This Section / Enlevez cette section / Retire esta sección



PARTS IDENTIFIER / IDENTIFICATEUR DE PIÈCES / IDENTIFICADOR DE PIEZAS

CONTENTS OF BOX 2 / CONTENU DE LA BOÎTE 2 / CONTENIDO DE LA CAJA 2



HARDWARE BAGS / SACS DE QUINCAILLERIE / BOLSAS DE HERRAJE



CONTENTS OF BOX 3 / CONTENU DE LA BOÎTE 3 / CONTENIDO DE LA CAJA 3

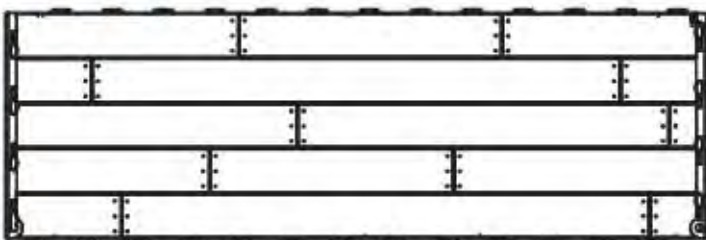

CUD (x2)



AHD (x4)

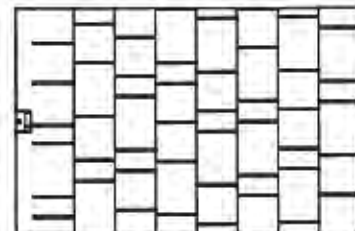

AGQ (x4)

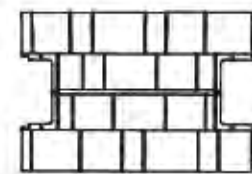

AFY (x2)

METAL PARTS KIT 3 / KIT PIÈCES EN MÉTAL 3 / KIT DE PIEZAS DE METAL 3

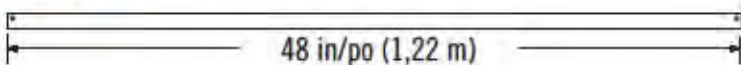

AFG (x2)



DSR (x4)



Remove This Section / Enlevez cette section / Retire esta sección

► SECTION 9 (CONTINUED) / SECTION 9 (SUITE) / SECCIÓN 9 (CONTINUACIÓN)

TOOLS AND HARDWARE REQUIRED / OUTILS ET QUINCAILLERIE REQUIS / INSTRUMENTAL Y HERRAJE REQUERIDOS

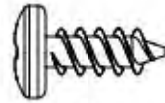

ADZ (x6)

9.2

- Insert the **Shelf Brackets (AIY)** into the slots in the Wall/Shelf Support Channels. **The Brackets must be at the same height.**
- Insérez les **équerres (AIY)** dans les fentes dans les canaux de support pour les murs/étagères. **Les équerres doivent être à la même hauteur.**
- Inserte las **escuadras (AIY)** en las ranuras en los canales de soporte para los muros/estantes. **Las Escuadras deben estar a la misma altura.**

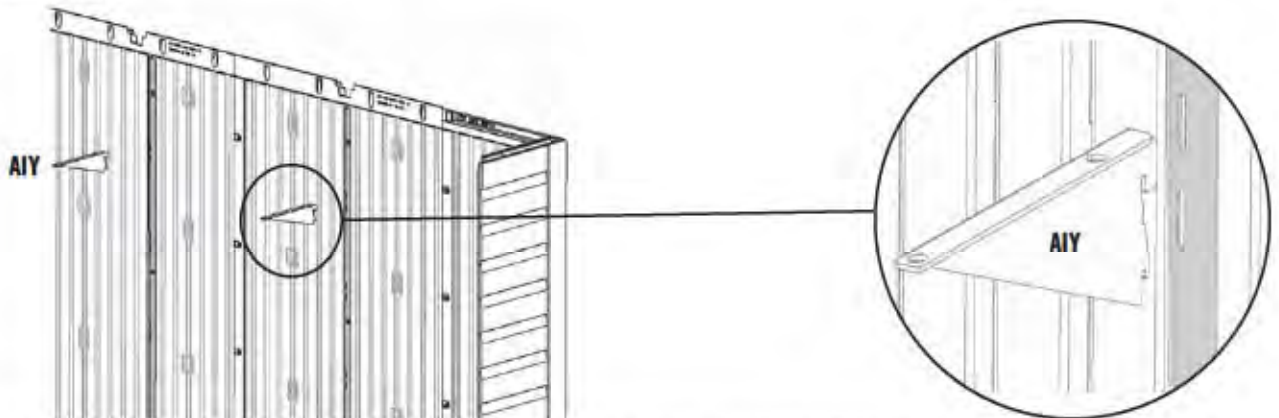

9.3

- Attach the **Shelf (AFV)** to the Corner Wall Panels and Shelf Brackets using six (6) **Screws (ADZ)**.
- Attachez l'**étagère (AFV)** aux panneaux angulaires et aux équerres à l'aide de six (6) **vis (ADZ)**.
- Sujete el **estante (AFV)** a los paneles angulares y las escuadras usando seis (6) **tornillos (ADZ)**.

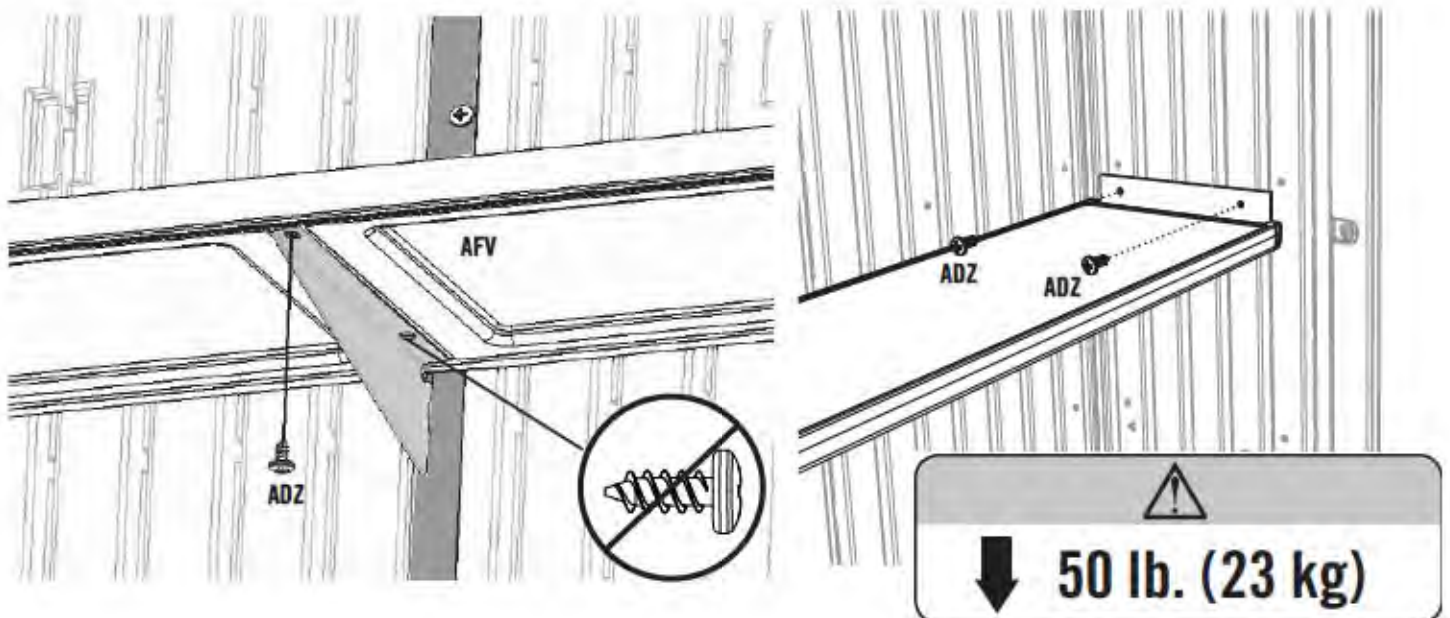

► SECTION 9 (CONTINUED) / SECTION 9 (SUITE) / SECCIÓN 9 (CONTINUACIÓN)

TOOLS AND HARDWARE REQUIRED / OUTILS ET QUINCAILLERIE REQUIS / INSTRUMENTAL Y HERRAJE REQUERIDOS

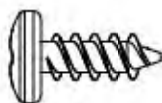

ADZ (x16)

9.4

- Select the corner in which you would like to install a **Corner Shelf (AFZ)**. Fold up the flaps of the Shelf, and align the holes in the tabs with those in the Corner Wall Panel. Secure with four (4) **Screws (ADZ)**.
- Sélectionnez l'encoignure dans laquelle vous souhaitez installer une **étagère angulaire (AFZ)**. Pliez les rabats de l'étagère angulaire, et alignez les trous avec ceux du panneau mural angulaire. Attachez l'étagère au panneau à l'aide de quatre (4) **vis (ADZ)**.
- Seleccione el rincón en el cual le gustaría instalar un **estante angular (AFZ)**. Pliegue las solapas del estante, y alinee los agujeros en las solapas con ellos en el panel mural angular. Sujete el estante al panel usando cuatro (4) **tornillos (ADZ)**.

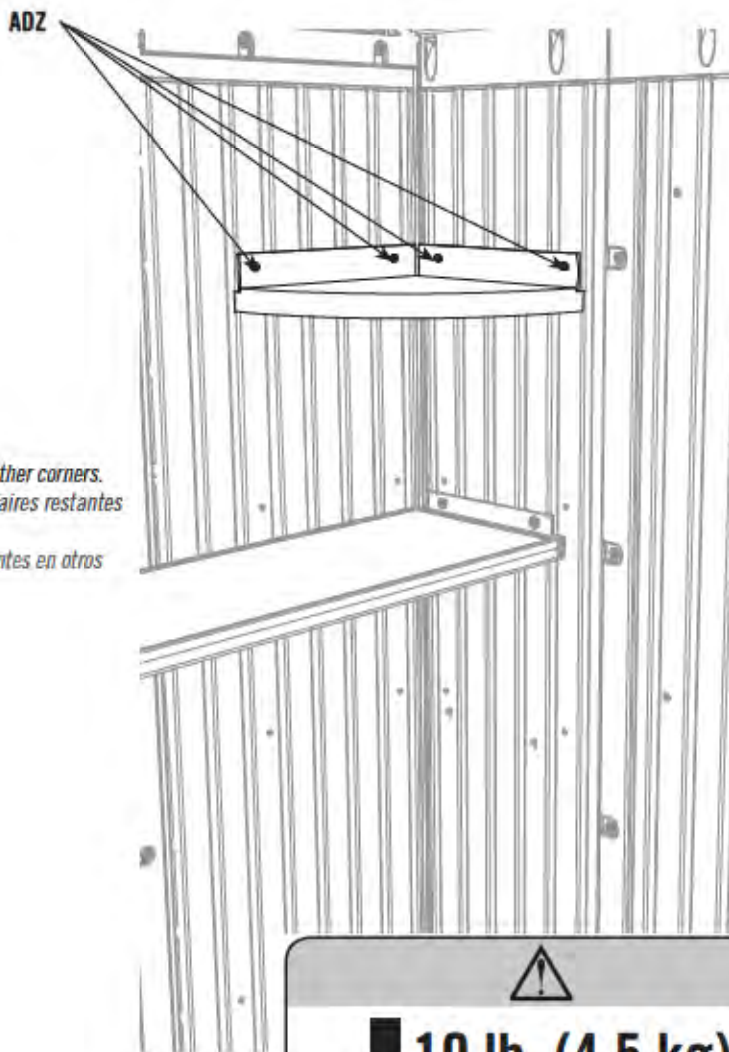
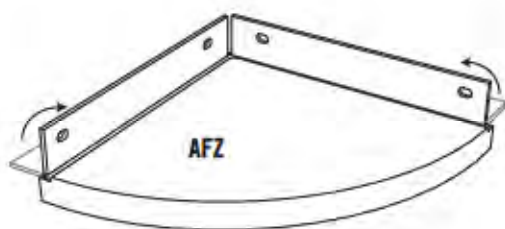

*Note: Repeat this step to place the remaining Corner Shelves in other corners.
Remarque : Répétez cette étape pour attacher les étagères angulaires restantes dans les autres encoignures.
Nota: Repita este paso para sujetar los estantes angulares restantes en otros rincones.*



AFZ (x2)

↓ **10 lb. (4.5 kg)**



HARDWARE REQUIRED / QUINCAILLERIE REQUISE / HERRAJE REQUERIDO

Hardware Bag / Sac de quincaillerie / Bolsa de herraje

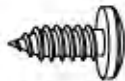

ADX (x40)

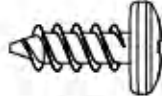

ADZ (x205)

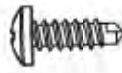

BHJ (x2)



DTV (x2)



AEE (x2)



CXK (x2)

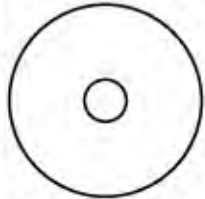

AED (x36)



AHP (x4)

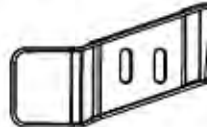

AIM (x1)



AIC (x1)

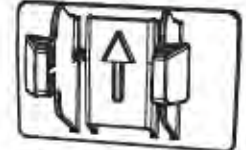

AXX (x2)



ECR (x1)

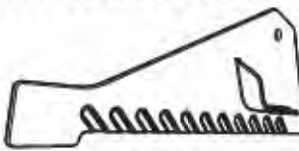

ECS (x1)



ADK (x2)

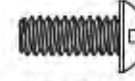

BZA (x2)



AEE (x4)



PARTS REQUIRED / PIÈCES REQUISES / PIEZAS REQUERIDAS

Metal Parts / Pièces en métal / Piezas de metal



AFL (x12)



(x1)

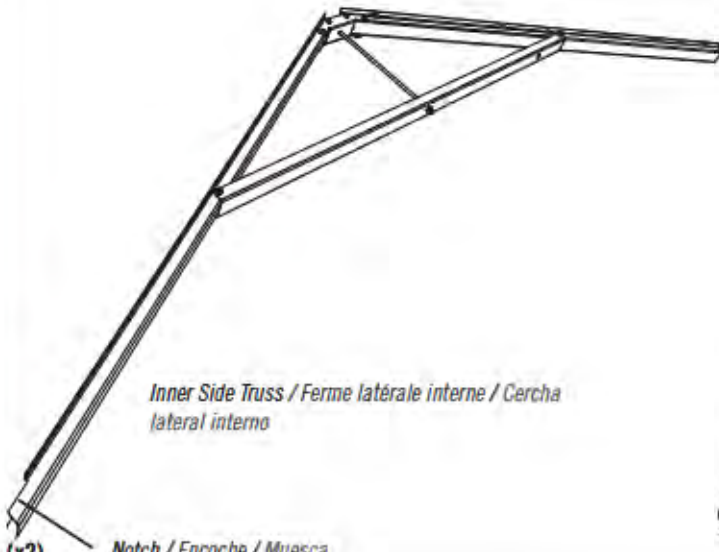

Inner Side Truss / Ferme latérale interne / Cercha lateral interno

(x2) Notch / Encoche / Muesca

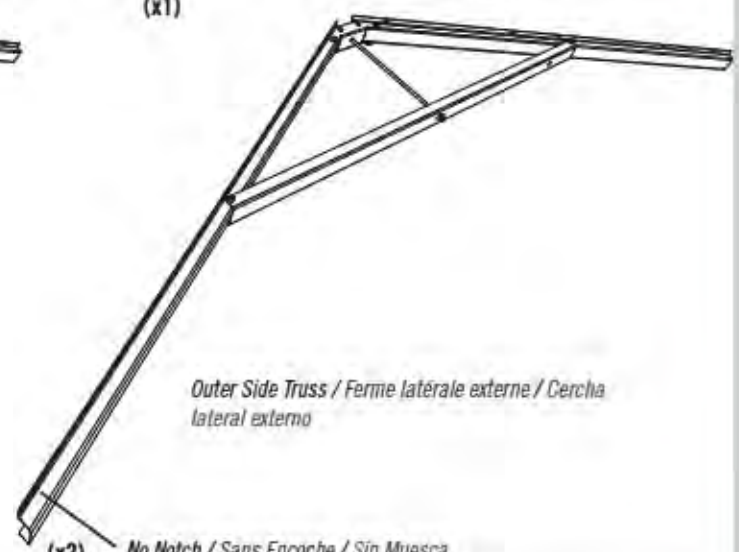

Outer Side Truss / Ferme latérale externe / Cercha lateral externo

(x2) No Notch / Sans Encoche / Sin Muesca



PARTS REQUIRED / PIÈCES REQUISES / PIEZAS REQUERIDAS

Plastic Parts / Pièces en plastique / Piezas de plástico



BDJ (x1)



BDK (x1)

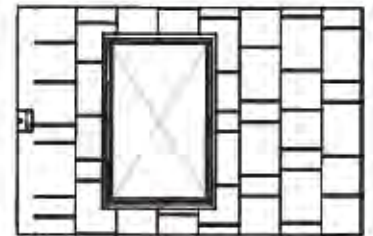

(x2)



AGO (x1)



AGZ (x1)

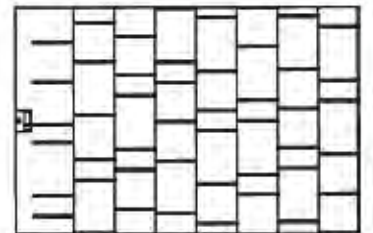

AGQ (x8)



(x1)

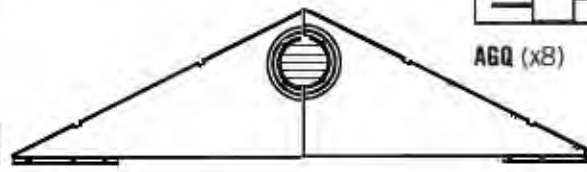

(x1)

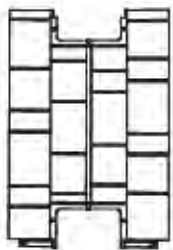

AFY (x5)

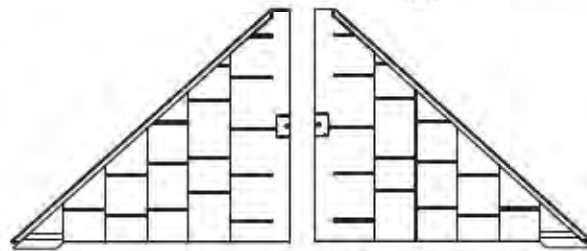

BDR (x1)

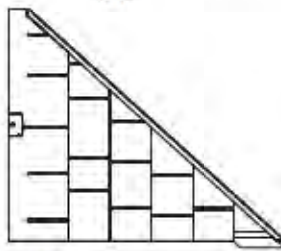

BDS (x1)



(x1)



AHC (x6)



DRB (x1)



AGG (x1)



AFW (x1)



DRA (x1)



TOOLS REQUIRED / OUTILS REQUIS / INSTRUMENTAL REQUERIDO



3/8 in/po (10 mm)



► SECTION 10 (CONTINUED) / SECTION 10 (SUITE) / SECCIÓN 10 (CONTINUACIÓN)

TOOLS AND HARDWARE REQUIRED / OUTILS ET QUINCAILLERIE REQUIS / INSTRUMENTAL Y HERRAJE REQUERIDOS

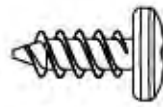

ADZ (x14)

10.1

- Attach a Side Gable to the Shed using fourteen (14) Screws (ADZ).
- Attachez un pignon latéral à l'abri à l'aide de quatorze (14) vis (ADZ).
- Sujete una fachada lateral a la caseta usando catorce (14) tornillos (ADZ).

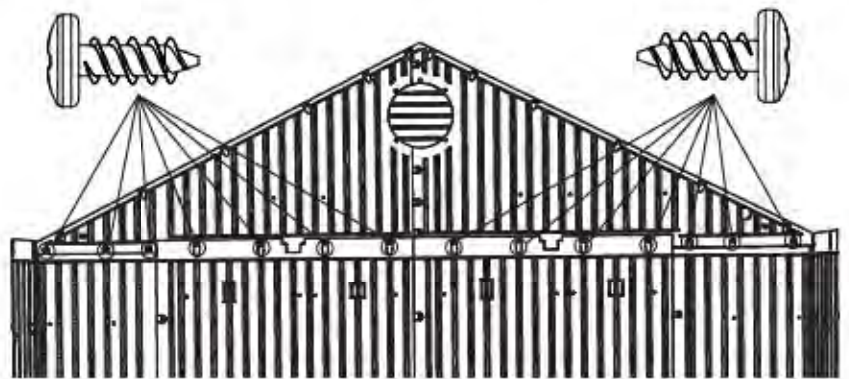

10.2

- Place a Outer Side Truss into the notches on the rear Wall Panel and Left Front Window Wall Panel. While another adult holds this in place, continue to the next step. **Do not use a Truss with a notch on either end.**
- Mettez une ferme latérale externe dans les encoches sur le panneau mural arrière et le panneau mural avant gauche pour la fenêtre. Pendant qu'un autre adulte soutient la ferme en place, continuez à la prochaine étape. **N'utilisez pas une ferme avec un encoche dans les extrémités.**
- Coloque una cercha lateral externo en las muescas en el panel mural trasero y el panel mural delantero izquierdo para la ventana. Mientras que otro adulto mantenga la cercha en su lugar, siga al próximo paso. **No use una cercha con una muesca en los extremos.**

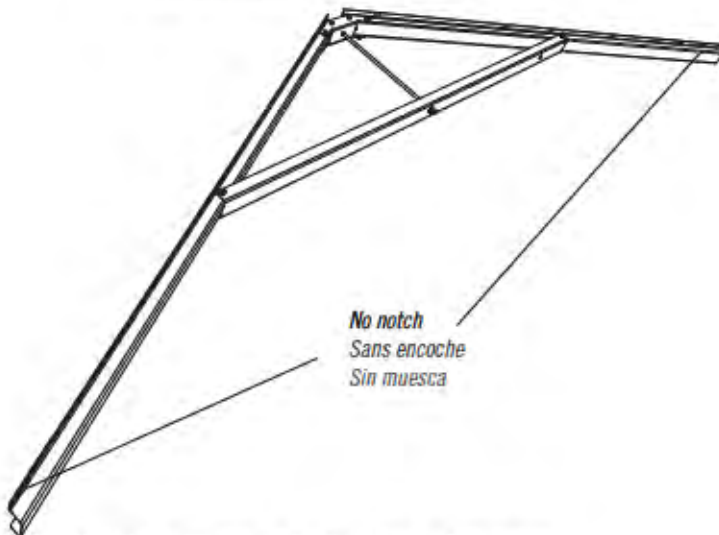

No notch
Sans encoche
Sin muesca

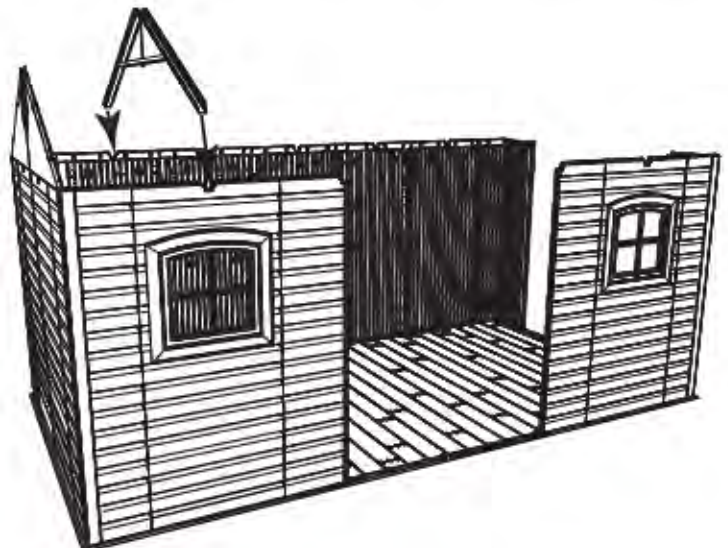

Outer Side Truss / Ferme latérale externe / Cercha lateral externo

► SECTION 10 (CONTINUED) / SECTION 10 (SUITE) / SECCIÓN 10 (CONTINUACIÓN)

TOOLS AND HARDWARE REQUIRED / OUTILS ET QUINCAILLERIE REQUIS / INSTRUMENTAL Y HERRAJE REQUERIDOS

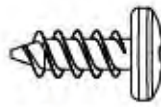

ADZ (x4)

10.3

- Set the **Roof Panel (AHB)** down onto the Wall Panel, Gable, and Truss. The groove at the bottom of the Roof Panel sets over the top of the Wall Panel. Ensure the alignment nub fits into the notch in the Truss.
- Mettez le **panneau de toit (AHB)** dans le panneau mural, le pignon, et la ferme. Mettez la rainure au bord inférieur du panneau de toit sur la partie supérieure du panneau mural. Mettez la petite bosse d'alignement dans l'encoche de la ferme.
- Coloque el **panel de tejado (AHB)** en el panel de pared, la fachada, y la cercha. Coloque la ranura a lo largo del borde inferior del panel de tejado sobre la parte superior del panel de pared. Encaje el bulto de alineamiento en la muesca en la cercha.

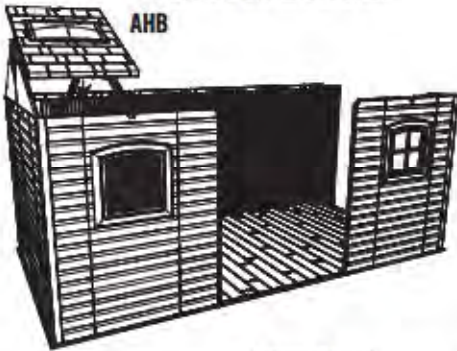

AHB

Alignment nub
Petite bosse d'alignement
Bulto de alineamiento

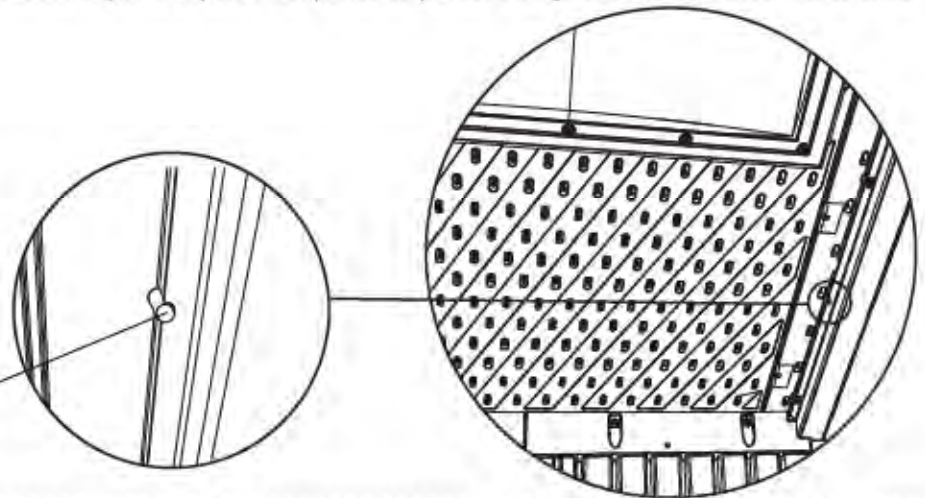

10.4

- Align the four holes in the Wall Panel with those at the bottom of the Roof Panel, and insert four (4) **Screws (ADZ)** to secure the Panel in place.
- Alignez les quatre trous dans le panneau mural avec ceux au bord inférieur du panneau de toit, et insérez quatre (4) **vis (ADZ)** pour attacher le panneau en place.
- Alinee los cuatro agujeros en el panel de pared con los al borde inferior del panel de tejado, e introduzca cuatro (4) **tornillos (ADZ)** para sujetarlo en su lugar.

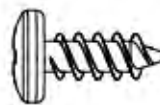

ADZ (x4)

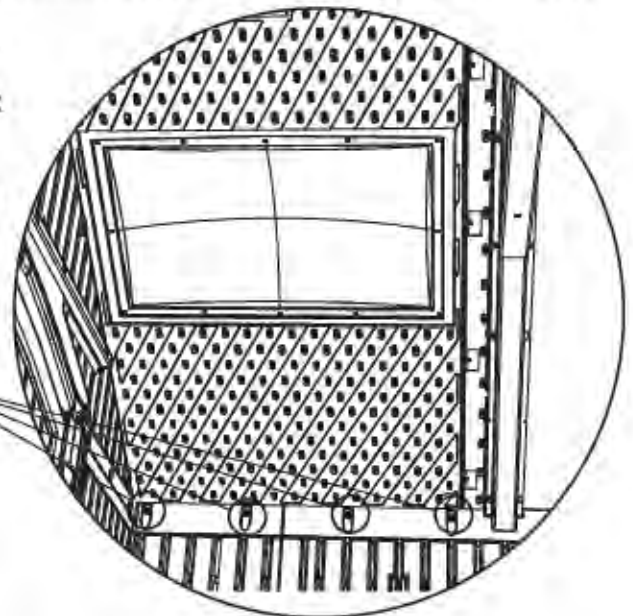

► SECTION 10 (CONTINUED) / SECTION 10 (SUITE) / SECCIÓN 10 (CONTINUACIÓN)

TOOLS AND HARDWARE REQUIRED / OUTILS ET QUINCAILLERIE REQUIS / INSTRUMENTAL Y HERRAJE REQUERIDOS

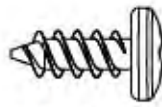

ADZ (x5)

10.5

- Now insert one (1) **Screw (ADZ)** through the Truss and into the Roof Panel and one (1) **Screw (ADZ)** through the Gable and into the Roof Panel. **Then, insert the Roof Support (AFL) into the notches.**
- Maintenant, mettez une (1) **vis (ADZ)** à travers la ferme et dans le panneau de toit et une (1) **vis (ADZ)** à travers le pignon et dans le panneau de toit. Ensuite, insérez le **support de toit (AFL)** dans les encoches.
- Ahora, inserte un (1) **tornillo (ADZ)** por la cercha y dentro del panel de tejado y un (1) **tornillo (ADZ)** por la fachada y dentro del panel de tejado. Entonces, inserte el **soporte de tejado (AFL)** en las muescas.

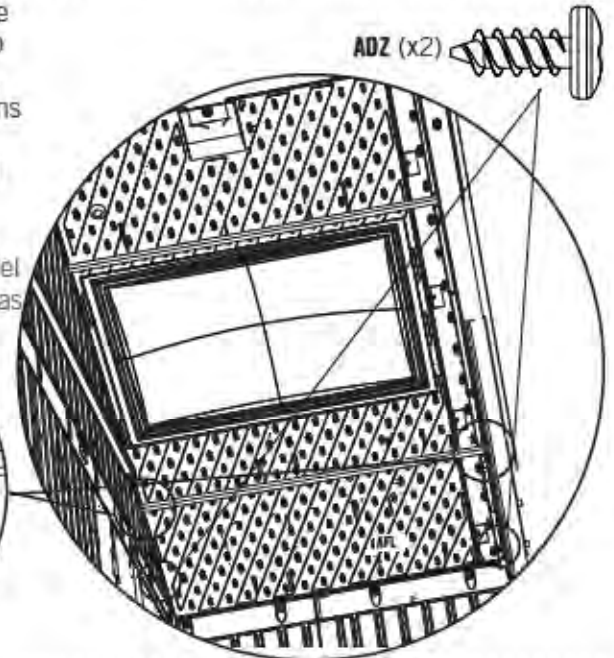
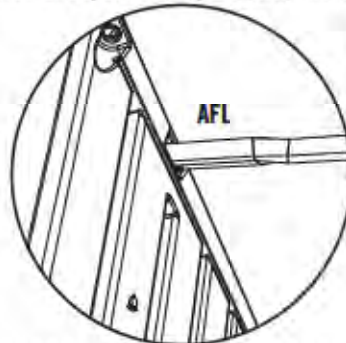

10.6

- Now, insert three (3) more **Screws (ADZ)** at the locations shown.
- Maintenant, insérez trois (3) **vis (ADZ)** aux emplacements illustrés.
- Ahora, introduzca tres (3) **tornillos (ADZ)** más a las ubicaciones ilustradas.

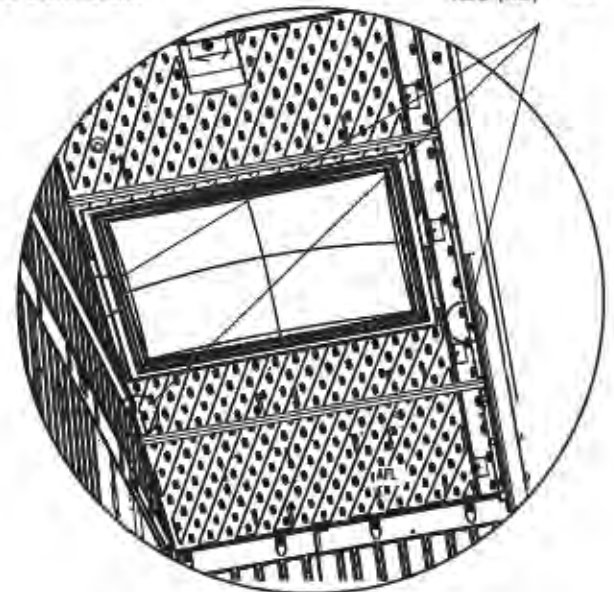
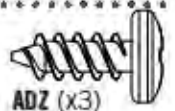

► SECTION 10 (CONTINUED) / SECTION 10 (SUITE) / SECCIÓN 10 (CONTINUACIÓN)

TOOLS AND HARDWARE REQUIRED / OUTILS ET QUINCAILLERIE REQUIS / INSTRUMENTAL Y HERRAJE REQUERIDOS

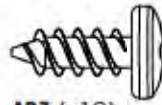

ADZ (x13)

10.7

• Now insert a second **Roof Support (AFL)** into the notches in the Gable and between the Truss and the Roof Panel as shown. Then, insert the last two (2) **Screws (ADZ)** at the locations shown.

• Maintenant, mettez un deuxième **support de toit (AFL)** dans les encoches dans le pignon et entre le panneau de toit et la ferme comme illustré. Ensuite, insérez les dernières deux (2) **vis (ADZ)** aux emplacements illustrés.

• Ahora, inserte un segundo **soporte de tejado (AFL)** en las muescas en la fachada y entre la cercha y el panel de tejado como se muestra. Entonces, introduzca los dos (2) últimos **tornillos (ADZ)** a las ubicaciones ilustradas.

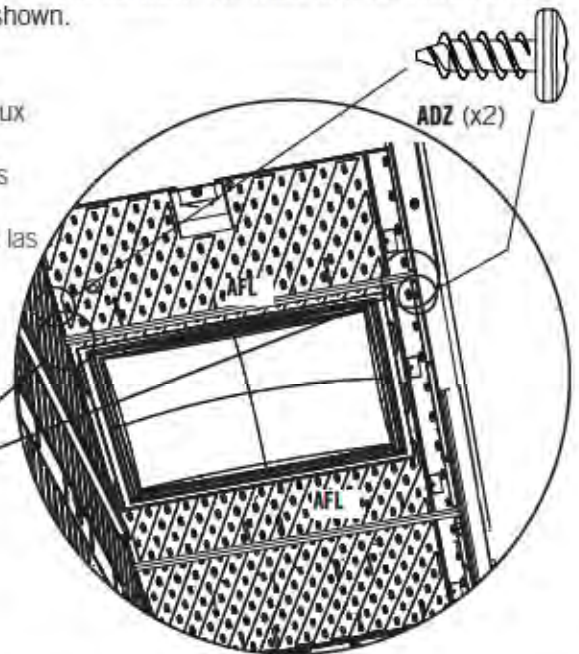
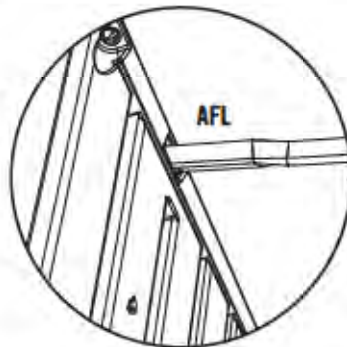

10.8

• Repeat these steps for the rear Roof Panel, but only use one Roof Support for each Roof Panel (AGQ).

• Répétez ces étapes pour le panneau de toit arrière, mais n'utilisez qu'un support de toit pour chaque panneau de toit (AGQ).

• Repita estos pasos para el panel de tejado trasero, mas use sólo un soporte de tejado para cada panel de tejado (AGQ).

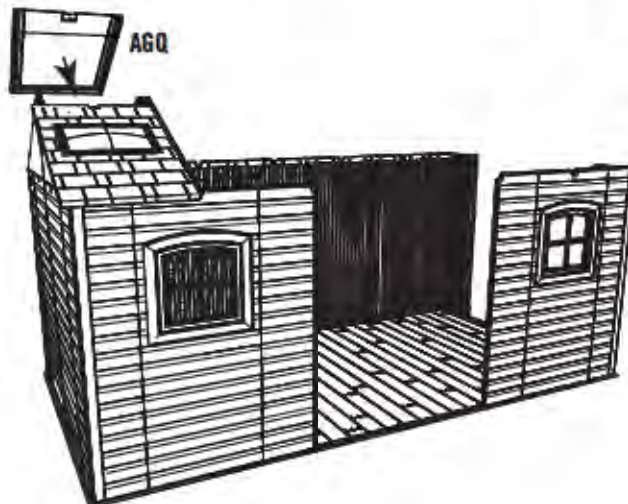

► SECTION 10 (CONTINUED) / SECTION 10 (SUITE) / SECCIÓN 10 (CONTINUACIÓN)

TOOLS AND HARDWARE REQUIRED / OUTILS ET QUINCAILLERIE REQUIS / INSTRUMENTAL Y HERRAJE REQUERIDOS

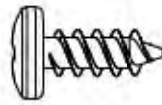

ADZ (x4)

10.9

- Set an Inner Side Truss onto the notches in the Wall Panels as shown.
- Mettez une ferme latérale interne sur les encoches dans les panneaux muraux comme illustré.
- Coloque una cercha lateral interno en las muescas en los paneles murales como se muestra.

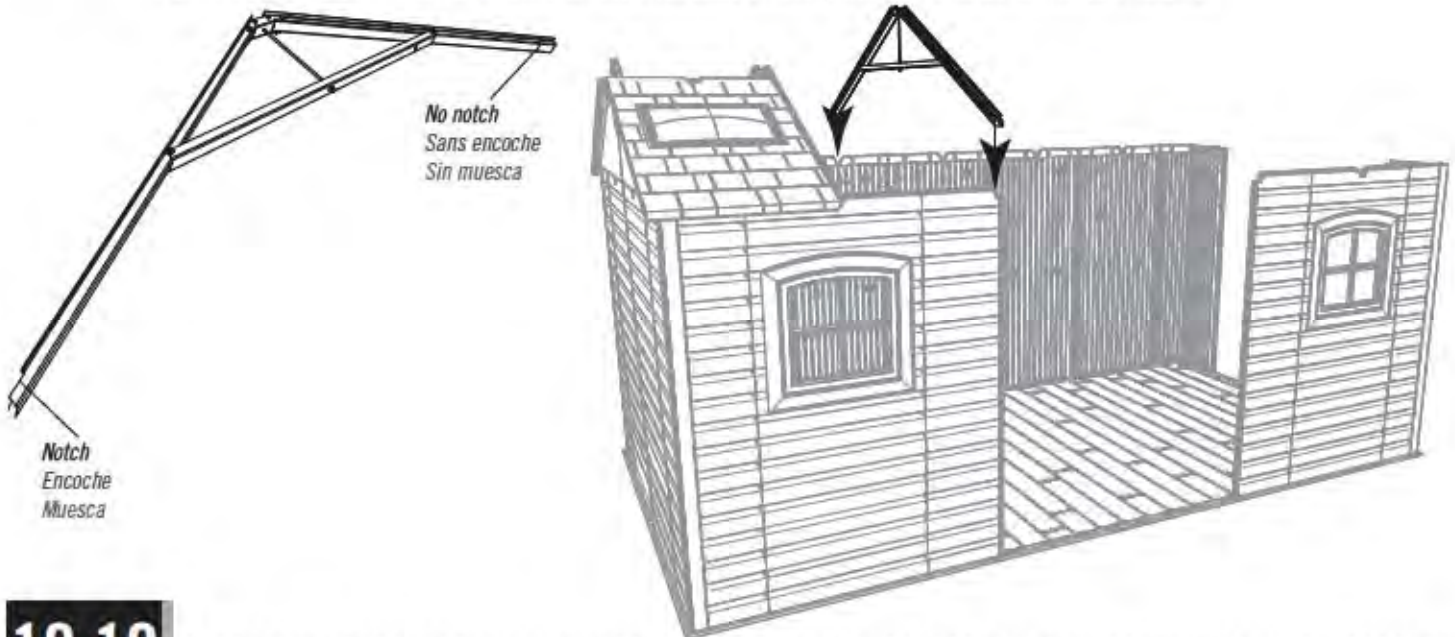

10.10

- Set an Inner Side Truss onto the notches in the Wall Panels as shown. **Roof Panels in these locations only use ten (10) Screws (ADZ) each.**
- Mettez une ferme latérale interne sur les encoches dans les panneaux muraux comme illustré. **Les panneaux de toit dans ces emplacements utilisent seulement dix (10) vis (ADZ) chaque un.**
- Coloque una cercha lateral interno en las muescas en los paneles murales como se muestra. **Los paneles de tejado en estas ubicaciones usan sólo diez (10) tornillos (ADZ) cada uno.**

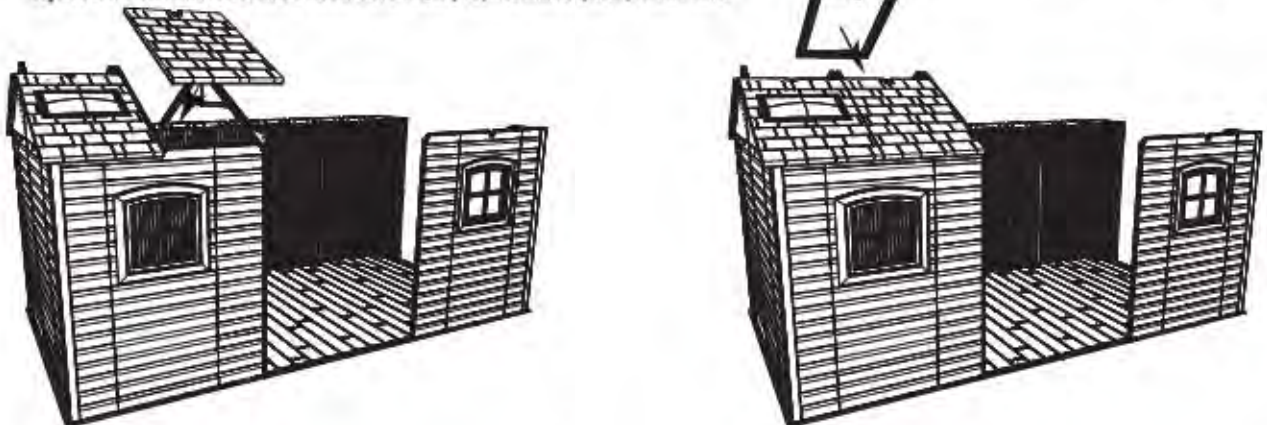

► SECTION 10 (CONTINUED) / SECTION 10 (SUITE) / SECCIÓN 10 (CONTINUACIÓN)

TOOLS AND HARDWARE REQUIRED / OUTILS ET QUINCAILLERIE REQUIS / INSTRUMENTAL Y HERRAJE REQUERIDOS



AHP (x1)

10.11

- Pull the Hinge Tube down out of the Left Door (the Door without the notched corner) about six inches. Align the hole at the bottom of the Hinge Tube with the slit in the Bushing, and insert the Tube. Insert a **Cotter Pin (AHP)** and bend the ends.
- Éteignez le tube d'articulation à peu près quinze centimètres du bord inférieur de la porte (la porte sans encoche). Alignez le trou dans la partie inférieure du tube avec la fente dans la bague, et insérez le Tube. Insérez une **clavette (AHP)** et pliez les extrémités.
- Extienda el tubo de articulación unos quince centímetros del borde inferior de la puerta (la puerta sin la muesca). Alinee el agujero en la parte inferior del tubo con la rendija en el casquillo, e inserte el tubo. Inserte una **clavija (AHP)** y doble los extremos.

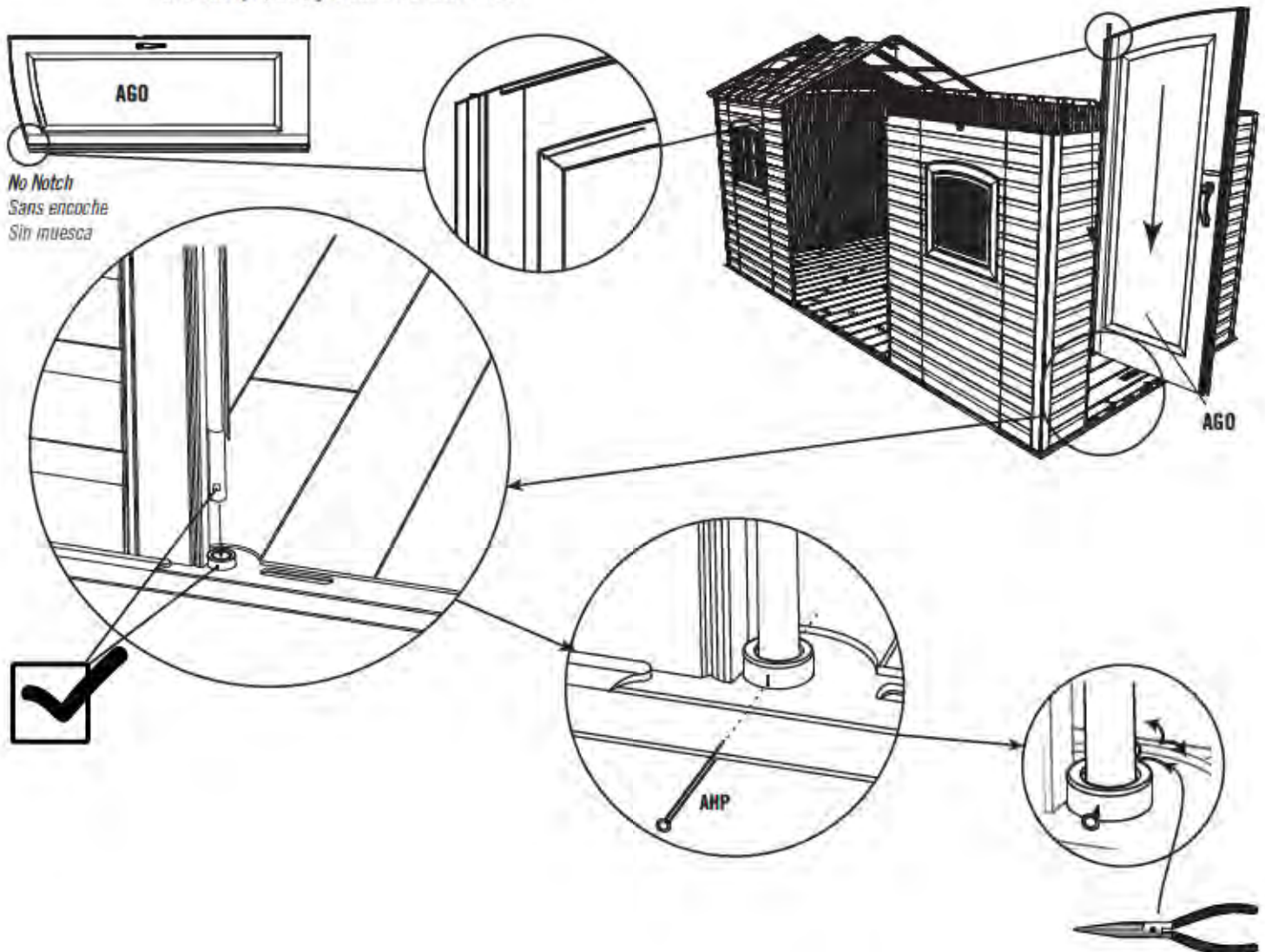

► SECTION 10 (CONTINUED) / SECTION 10 (SUITE) / SECCIÓN 10 (CONTINUACIÓN)

TOOLS AND HARDWARE REQUIRED / OUTILS ET QUINCAILLERIE REQUIS / INSTRUMENTAL Y HERRAJE REQUERIDOS



AHP (x1)

10.12

- Repeat this step for the Right Door.
- Répétez cette étape pour la porte droite.
- Repita este paso para la puerta derecha.

No Notch
Sans encoche
Sin muesca



10.13

- Slide the holes in the **Entry Gable (AGF)** down over the two Hinge Tubes.
- Glissez les trous dans le **pignon d'entrée (AGF)** sur les deux tubes.
- Deslice los agujeros en la **fachada de entrada (AGF)** sobre los dos tubos.



► SECTION 10 (CONTINUED) / SECTION 10 (SUITE) / SECCIÓN 10 (CONTINUACIÓN)

TOOLS AND HARDWARE REQUIRED / OUTILS ET QUINCAILLERIE REQUIS / INSTRUMENTAL Y HERRAJE REQUERIDOS

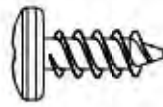

ADZ (x6)

10.14

- Secure the Entry Gable to the Shed using six (6) **Screws (ADZ)**.
- Attachez le pignon d'entrée à l'abri à l'aide de six (6) **vis (ADZ)**.
- Sujete la fachada de entrada a la caseta usando seis (6) **tornillos (ADZ)**.

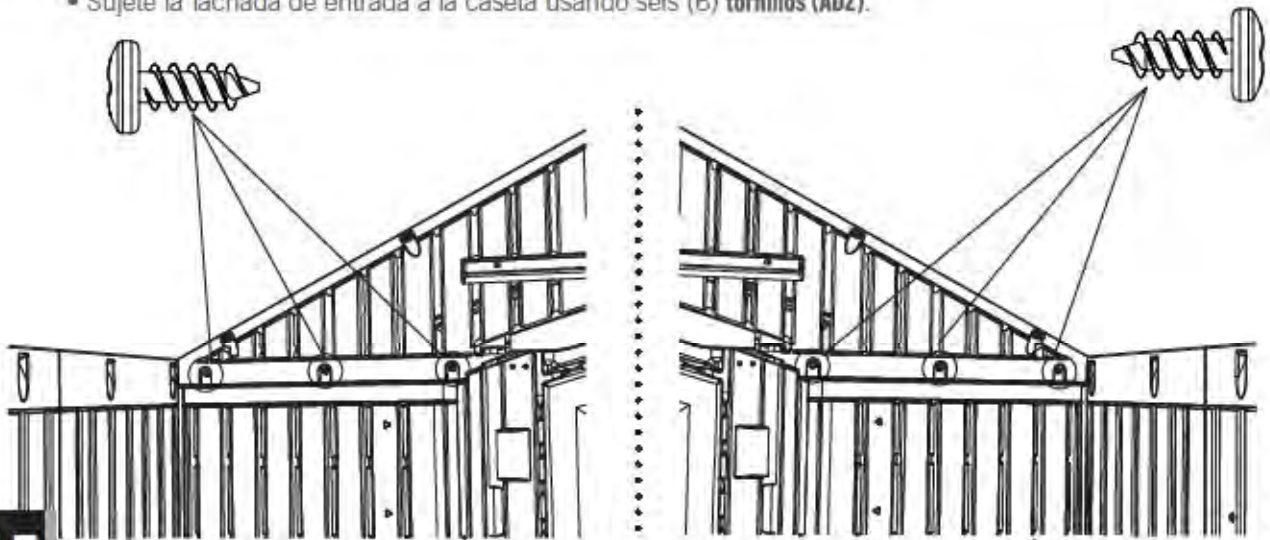

10.15

- Place a Outer Side Truss into the notches on the rear Wall Panel and Right Front Window Wall Panel. While another adult holds this in place, continue to the next step. **Do not use a Truss with a notch on either end.**
- Mettez une ferme latérale externe dans les encoches sur le panneau mural arrière et le panneau mural avant droit pour la fenêtre. Pendant qu'un autre adulte soutient la ferme en place, continuez à la prochaine étape. **N'utilisez pas une ferme avec un encoche dans les extrémités.**
- Coloque una cercha lateral externo en las muescas en el panel mural trasero y el panel mural delantero derecho para la ventana. Mientras que otro adulto mantenga la cercha en su lugar, siga al próximo paso. **No use una cercha con una muesca en los extremos.**

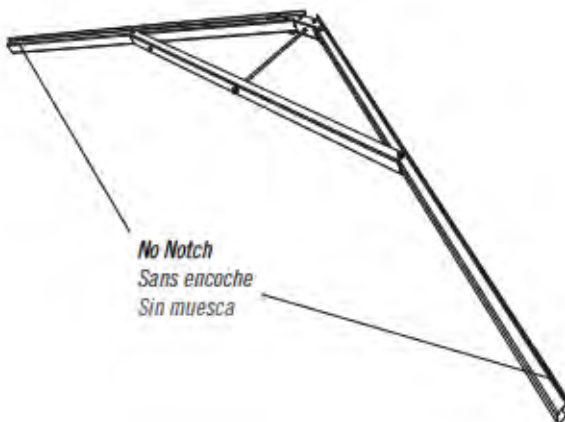

► SECTION 10 (CONTINUED) / SECTION 10 (SUITE) / SECCIÓN 10 (CONTINUACIÓN)

TOOLS AND HARDWARE REQUIRED / OUTILS ET QUINCAILLERIE REQUIS / INSTRUMENTAL Y HERRAJE REQUERIDOS

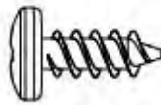

ADZ (x22)

10.16

- Attach the right front and rear **Roof Panels (AHB & AGQ)** to the shed keeping in mind the **Roof Panel for Domed Skylight (AHB)** uses two (2) **Roof Supports (AFL)** while the **Roof Panel (AGQ)** uses only one (1) **Roof Support (AFL)**.
- Attachez les **panneaux de toit (AHB et AGQ)** avant et arrière droits à l'abri en tenant compte que les **panneaux de toit pour la lucarne (AHB)** utilisent deux (2) **supports de toit (AFL)** pendant que les **panneaux de toit (AGQ)** utilisent un (1) **support de toit (AFL)** seulement.
- Sujete los **paneles de tejado (AHB y AGQ)** delantero y trasero derechos a la caseta teniendo en cuenta que el **panel de tejado para el tragaluz (AHB)** utiliza dos (2) **soportes de tejado (AFL)** mientras que el **panel de tejado (AGQ)** utilice sólo un (1) **soporte de tejado (AFL)**.

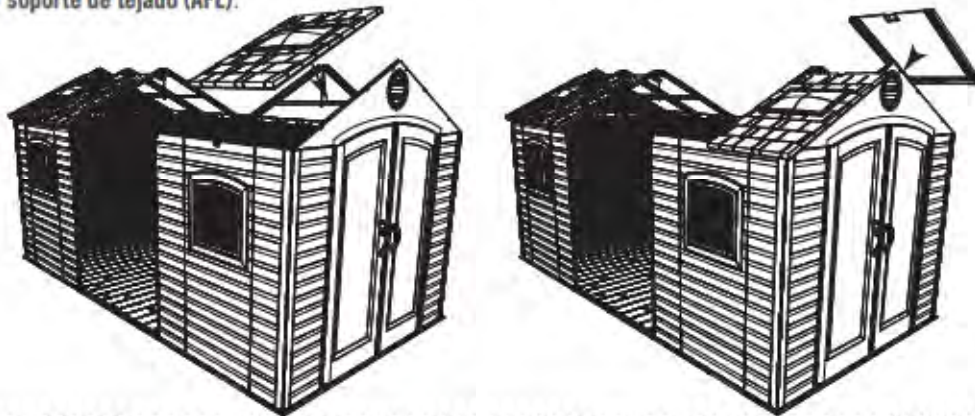

10.17

- Place a **Innser Side Truss** into the notches on the **Wall Panels**. While another adult holds this in place, continue to the next step.
- Mettez une **ferme latérale externe** dans les encoches sur le **panneau mural arrière** et le **panneau mural avant droit** pour la fenêtre. Pendant qu'un autre adulte soutient la ferme en place, continuez à la prochaine étape.
- Coloque una **cercha lateral externo** en las muescas en el **panel mural trasero** y el **panel mural delantero derecho** para la ventana. Mientras que otro adulto mantenga la cercha en su lugar, siga al próximo paso.

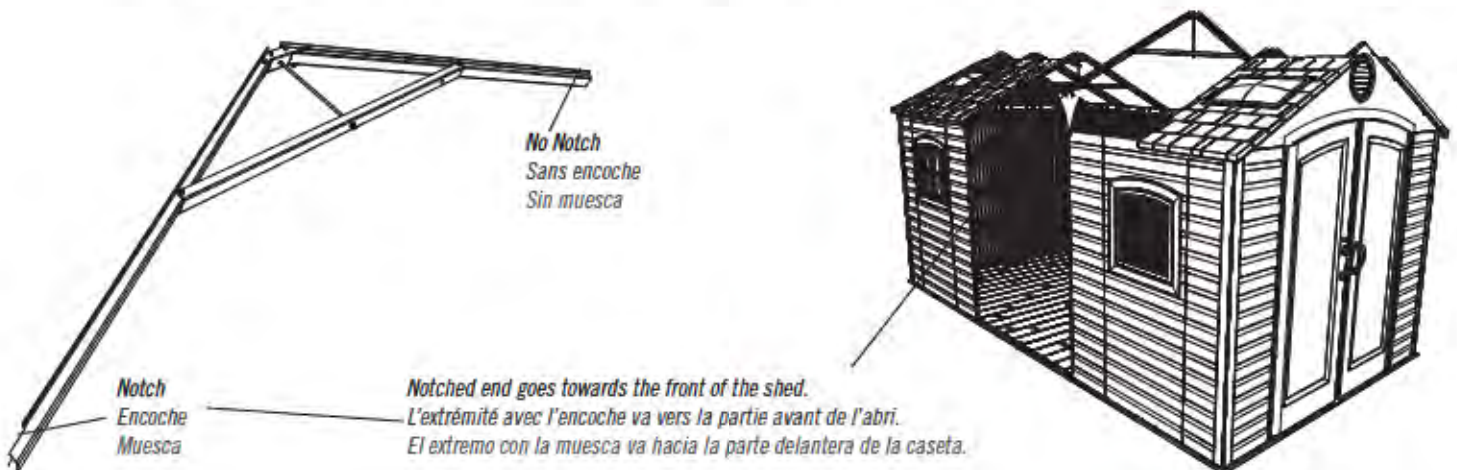

► SECTION 10 (CONTINUED) / SECTION 10 (SUITE) / SECCIÓN 10 (CONTINUACIÓN)

TOOLS AND HARDWARE REQUIRED / OUTILS ET QUINCAILLERIE REQUIS / INSTRUMENTAL Y HERRAJE REQUERIDOS

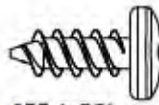

ADZ (x20)

10.18

- Attach the right front and rear **Roof Panels (AHB and AGQ)** to the shed keeping in mind the **Roof Panel for Domed Skylight (AHB)** uses two (2) **Roof Supports (AFL)** while the **Roof Panel (AGQ)** uses only one (1) **Roof Support (AFL)**.
- Attachez les **panneaux de toit (AHB et AGQ)** avant et arrière droits à l'abri en tenant compte que les **panneaux de toit pour la lucarne (AHB)** utilisent deux (2) **supports de toit (AFL)** pendant que les **panneaux de toit (AGQ)** utilisent un (1) **support de toit (AFL)** seulement.
- Sujete los **paneles de tejado (AHB y AGQ)** delantero y trasero derechos a la caseta teniendo en cuenta que el **panel de tejado para el tragaluz (AHB)** utiliza dos (2) **soportes de tejado (AFL)** mientras que el **panel de tejado (AGQ)** utilice sólo un (1) **soporte de tejado (AFL)**.

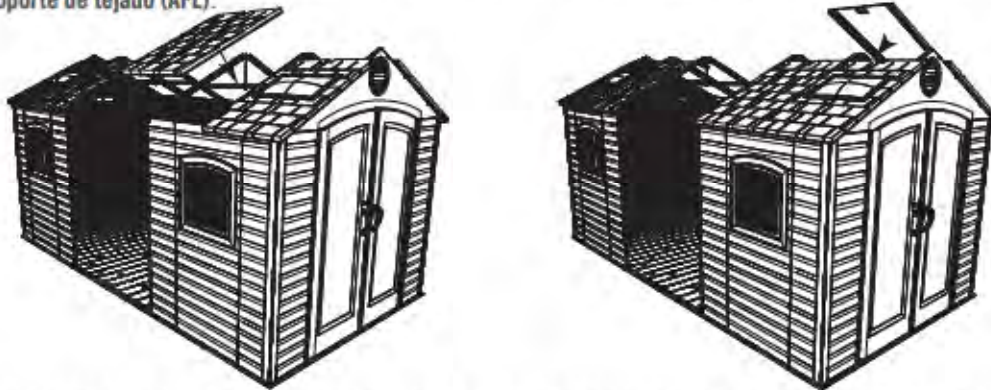

10.19

- Place the back of the **Center Truss** into the notch on the center rear **Wall Panel**. Then, lift the front of the **Truss** up so the ends of the **Roof Support Tube** touch the **Side Trusses**.
- Mettez l'extrémité arrière de la **ferme centrale** dans l'encoche sur le **panneau mural arrière central**. Ensuite, soulevez l'extrémité avant de la **ferme** pour que les extrémités du **tube de support** touchent les **fermes latérales**.
- Coloque el extremo trasero de la **cercha central** en la muesca en el **panel de tejado central trasero**. Entonces, levante el extremo delantero de la **cercha** para arriba para que los extremos del **tubo de soporte** hagan contacto con las **cerchas laterales**.



► SECTION 10 (CONTINUED) / SECTION 10 (SUITE) / SECCIÓN 10 (CONTINUACIÓN)

TOOLS AND HARDWARE REQUIRED / OUTILS ET QUINCAILLERIE REQUIS / INSTRUMENTAL Y HERRAJE REQUERIDOS



3/8 in/po
(10 mm)



DTV (x2)



AEE (x2)



CXK (x2)

10.20

- Secure the ends of the Support Tube to the Side Truss Channels using the hardware included.
- Attachez bien les extrémités du tube de support aux fermes latérales à l'aide de la quincaillerie incluse.
- Sujete los extremos del tubo de soporte a las cerchas laterales usando el herraje incluido.

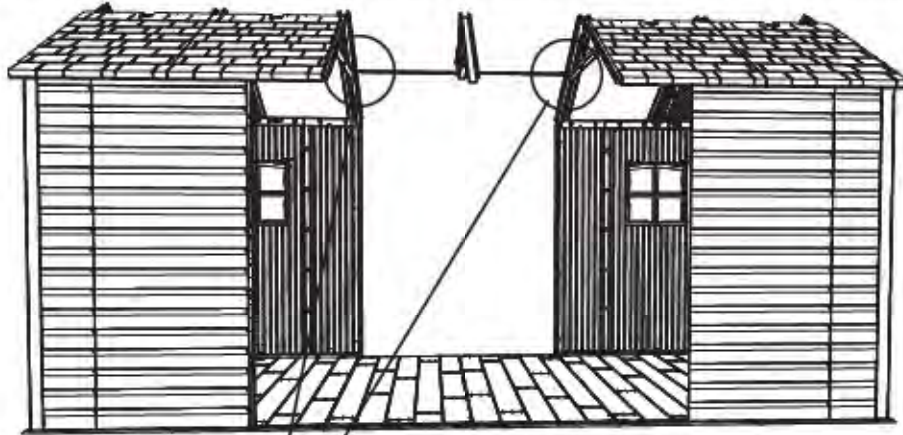

- This hole is near the Truss Brace.
- Ce trou est près le support de la ferme.
- Este agujero es cerca el soporte de la cercha.

- Rear Wall Panels not shown in this image
- Les panneaux muraux arrière ne sont pas illustrés dans cet image
- Los paneles traseros no son ilustrados en este imagen

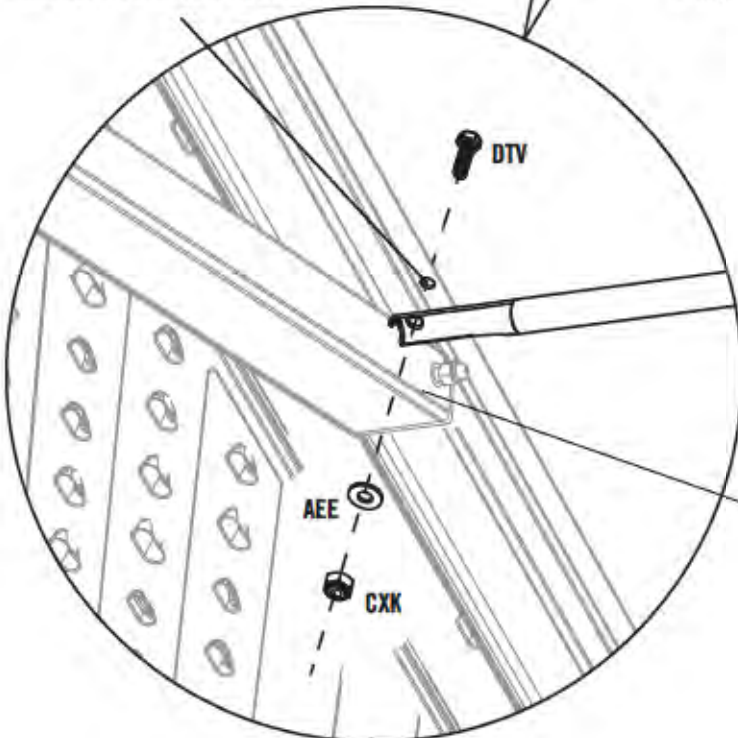

- Truss Brace.
- Support de la ferme.
- Soporte de la cercha.

► SECTION 10 (CONTINUED) / SECTION 10 (SUITE) / SECCIÓN 10 (CONTINUACIÓN)

TOOLS AND HARDWARE REQUIRED / OUTILS ET QUINCAILLERIE REQUIS / INSTRUMENTAL Y HERRAJE REQUERIDOS



AHP (x2)

10.21

- Pull the Hinge Tube down out of the Left Door (the Door with the notched corner) about six inches. Align the hole at the bottom of the Hinge Tube with the slit in the Bushing, and insert the Tube. Insert a **Cotter Pin (AHP)** and bend the ends.
- Éteignez le tube d'articulation à peu près quinze centimètres du bord inférieur de la porte (la porte avec l'encoche). Alignez le trou dans la partie inférieure du tube avec la fente dans la bague, et insérez le tube. Insérez une **clavette (AHP)** et pliez les extrémités.
- Extienda el tubo de articulación unos quince centímetros del borde inferior de la puerta (la puerta con la muesca). Alinee el agujero en la parte inferior del tubo con la rendija en el casquillo, e inserte el tubo. Inserte una **clavija (AHP)** y doble los extremos.

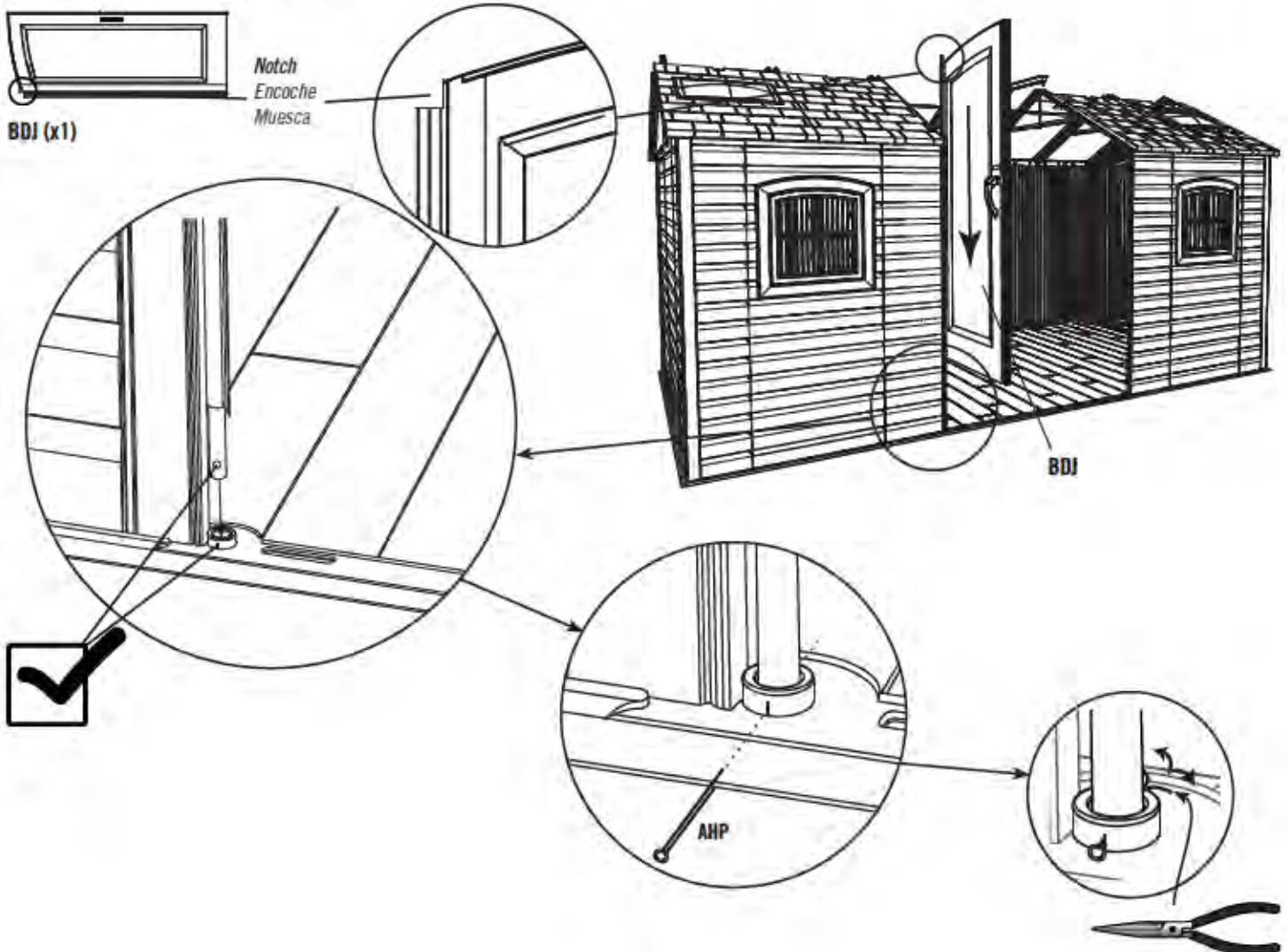

► SECTION 10 (CONTINUED) / SECTION 10 (SUITE) / SECCIÓN 10 (CONTINUACIÓN)

TOOLS AND HARDWARE REQUIRED / OUTILS ET QUINCAILLERIE REQUIS / INSTRUMENTAL Y HERRAJE REQUERIDOS



AHP (x1)

10.22

- Repeat the last step for the Right Door (with the notched corner).
- Répétez l'étape précédente pour la porte droite (avec l'encoche dans le coin).
- Repita el paso anterior para la puerta derecha (con la muesca en la esquina).

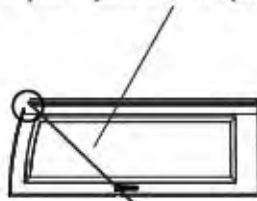

BDK (x1)

Notch
Encoche
Muesca



10.23

- Slide the holes in the Entry Gable down over the two Hinge Tubes.
- Glissez les trous dans le pignon d'entrée sur les deux tubes.
- Deslice los agujeros en la fachada de entrada sobre los dos tubos.

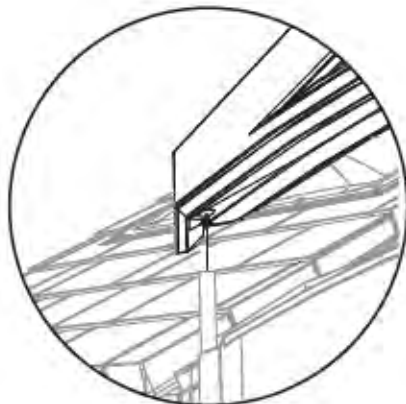

► SECTION 10 (CONTINUED) / SECTION 10 (SUITE) / SECCIÓN 10 (CONTINUACIÓN)

TOOLS AND HARDWARE REQUIRED / OUTILS ET QUINCAILLERIE REQUIS / INSTRUMENTAL Y HERRAJE REQUERIDOS

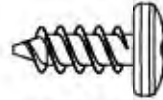

ADZ (x21)

10.24

- Set the end of the Center Truss onto the notch in the Front Gable as shown.
- Mettez l'extrémité de la ferme centrale dans l'encoche dans la pignon avant comme illustré.
- Coloque el extremo de la cercha central en la muesca en la fachada delantera como se muestra.

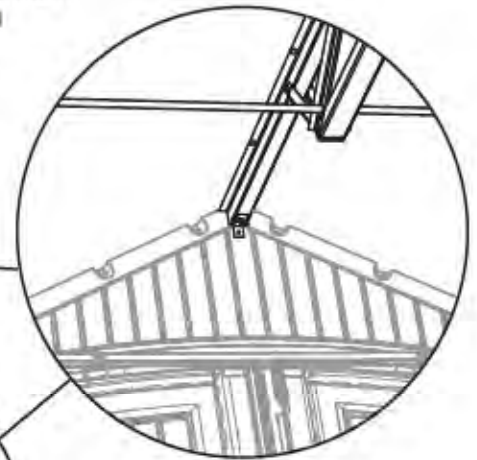
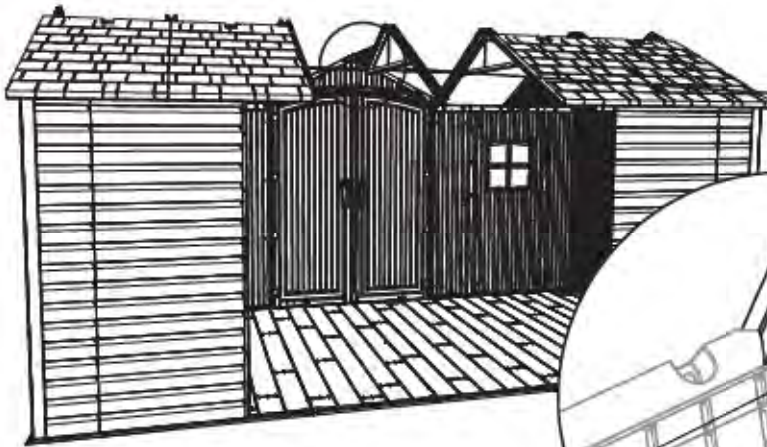

ADZ



*Note: Tighten this Nut and Bolt now.
Remarque : Serrez cette vis et l'écrou maintenant.
Nota: Apriete este perno y la tuerca ahora.*

10.25

- Attach the two center, rear **Roof Panels (AGQ)** using only one Roof Support per Panel.
- Attachez les deux **panneaux de toit (AGQ)** arrières centraux en utilisant un seul support de toit pour chaque panneau.
- Sujete los dos **paneles de tejado (AGQ)** traseros centrales usando sólo un soporte de tejado por panel.

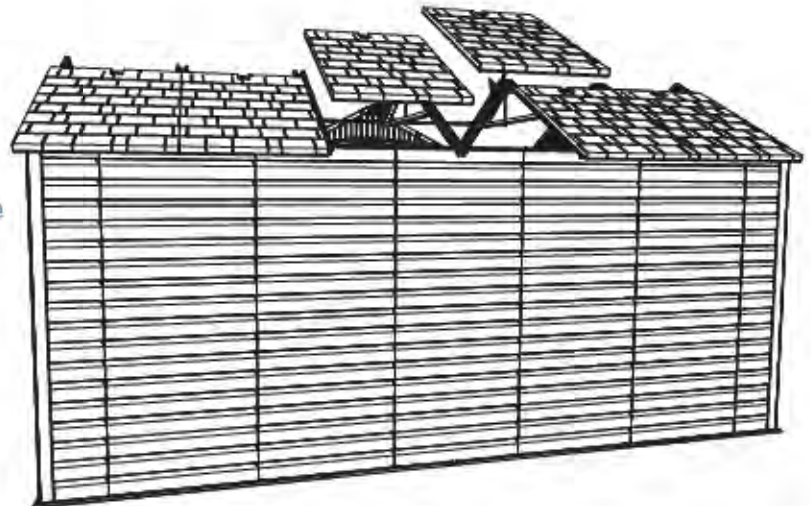

► SECTION 10 (CONTINUED) / SECTION 10 (SUITE) / SECCIÓN 10 (CONTINUACIÓN)

TOOLS AND HARDWARE REQUIRED / OUTILS ET QUINCAILLERIE REQUIS / INSTRUMENTAL Y HERRAJE REQUERIDOS



3/8 in/po
(10 mm)



ECS (x1)

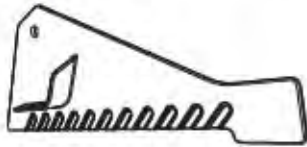

ECR (x1)



ADK (x2)



BZA (x2)



AEE (x4)

10.26

- Insert the **Right Drainage Plate (ECS)** into the Right Lateral Truss, and align the notch in the Plate with the first hole in the Truss as shown. Secure with the hardware included. **Only tighten by hand for now.**
- Insérez la **plaque de drainage droite (ECS)** dans la ferme latérale droite, et alignez l'encoche dans la plaque avec le premier trou dans la ferme comme illustré. Attachez-la bien à la ferme à l'aide de la quincaillerie incluse. **Ne serrez qu'à la main en ce moment.**
- Inserte la **placa derecha para el drenaje (ECS)** dentro de la cercha lateral derecho, y alinee la muesca en la placa con el primer agujero en la cercha. Sujétela a la cercha usando el herraje incluido. **Apriete sólo a mano en este momento.**

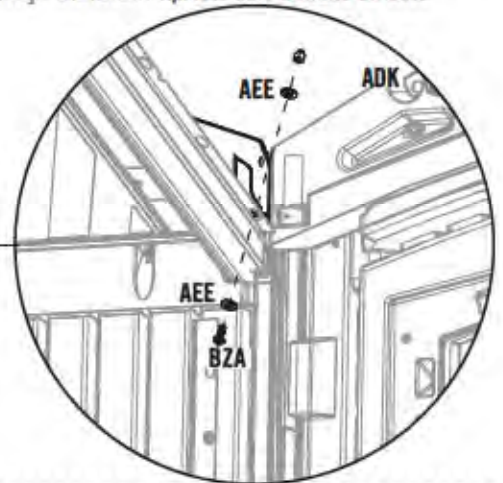

10.27

- Repeat the last step for the **Left Drainage Plate (ECR)**.
- Répétez l'étape précédente pour la **plaque de drainage gauche (ECR)**.
- Repita el paso anterior para la **placa izquierda para el drenaje (ECR)**.



► SECTION 10 (CONTINUED) / SECTION 10 (SUITE) / SECCIÓN 10 (CONTINUACIÓN)

TOOLS AND HARDWARE REQUIRED / OUTILS ET QUINCAILLERIE REQUIS / INSTRUMENTAL Y HERRAJE REQUERIDOS



3/8 in/po
(10 mm)

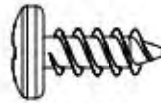

ADZ (x14)

10.28

- Fold the ends of the **Large Angled Roof Panel (DRA)** and set it down onto the shed as shown. Secure the Panel to the Entry Gable and Center Truss with twelve (12) **Screws (ADZ)** at the locations shown.
- Pliez les extrémités du **panneau de toit angulaire grand (DRA)** et mettez-le sur l'abri comme illustré. Attachez-le bien au pignon et à la ferme centrale à l'aide de douze (12) **vis (ADZ)** aux emplacements indiqués.
- Doble los extremos del **panel de tejado angular grande (DRA)** y colóquelo en la caseta como se muestra. Sujételo a la fachada y la cercha central usando doce (12) **tornillos (ADZ)** a las ubicaciones ilustradas.



*Note: Fold these ends upward before installing.
Remarque : Pliez ces rabats en haut avant d'installer.
Nota: Doble estas solapas hacia arriba antes de instalar.*

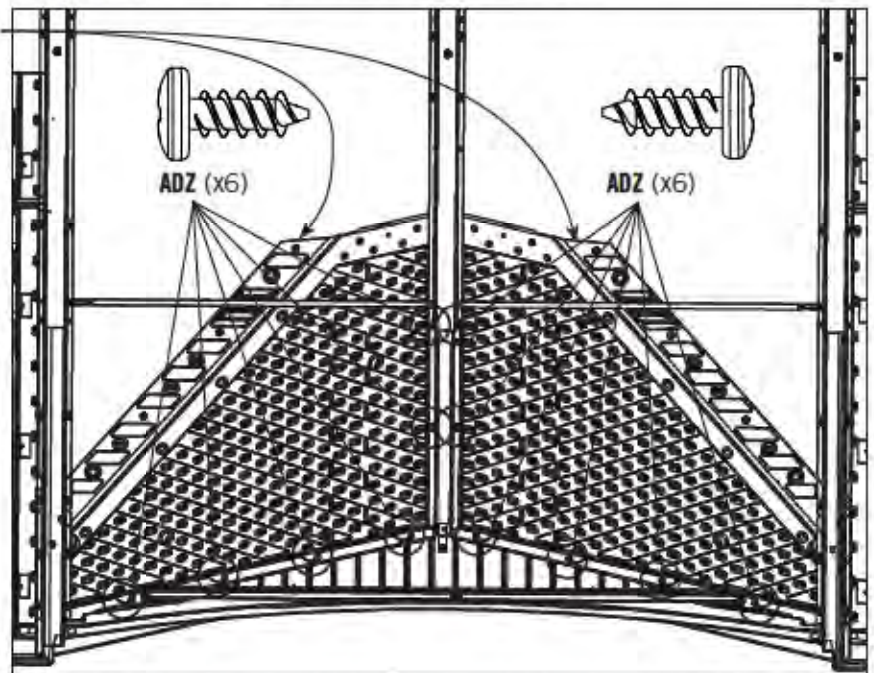
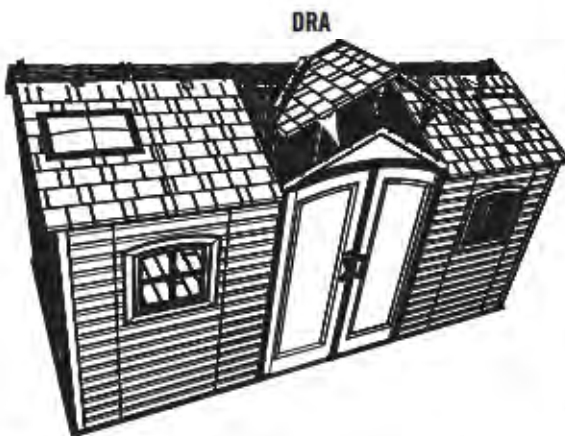

10.29

- Secure the Drainage Plate from step 10.26–10.27 to the Roof at the location shown. **Tighten the Nut on the Drainage Plate now. Repeat this step for the second Drainage Plate.**
- Attachez les plaques de drainage de l'étape 10.26 – 10.27 au toit à l'emplacement illustré. **Serrez l'écrou dans la plaque de drainage maintenant. Répétez cette étape pour l'autre plaque de drainage.**
- Sujete la placa de drenaje del paso 10.26–10.27 al tejado a la ubicación ilustrada. **Apriete la tuerca en la placa de drenaje ahora. Repita este paso para la otra placa de drenaje.**

ADZ

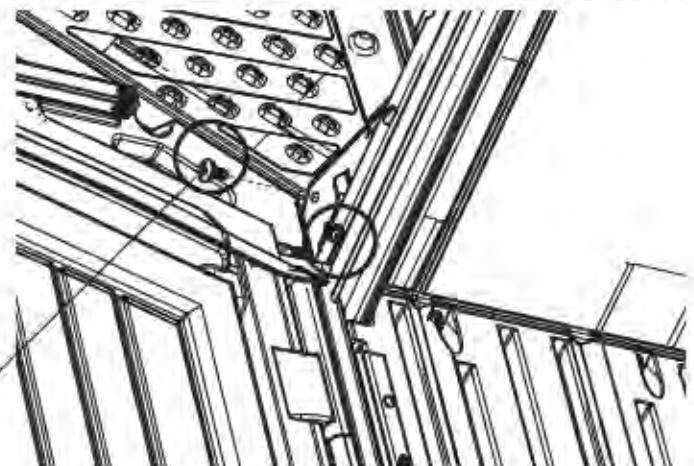

► SECTION 10 (CONTINUED) / SECTION 10 (SUITE) / SECCIÓN 10 (CONTINUACIÓN)

TOOLS AND HARDWARE REQUIRED / OUTILS ET QUINCAILLERIE REQUIS / INSTRUMENTAL Y HERRAJE REQUERIDOS

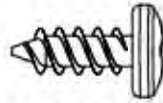

ADZ (x20)

10.30

- An adult must apply a downward pressure on **Panel (DRB)** while another inserts these **Screws (ADZ)**.
- Une adulte doit appliquer pression sur le **panneau (DRB)** pendant que vous insérez ces **vis (ADZ)**.
- Un adulto debe aplicar una presión de arriba en el **panel (DRB)** mientras que introduzca estos tornillos (ADZ).

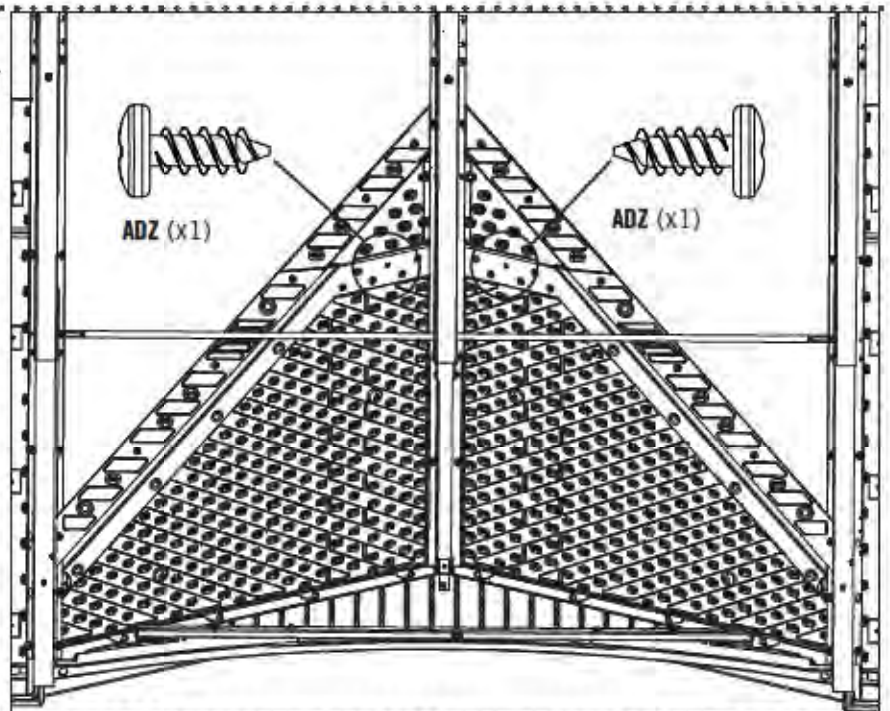

10.31

- An adult must apply a downward pressure on **Panels (BDS & BDR)** while another inserts these **Screws (ADZ)**.
- Une adulte doit appliquer pression sur les **panneaux (BDS et BDR)** pendant que vous insérez ces **vis (ADZ)**.
- Un adulto debe aplicar una presión de arriba en los **paneles (BDS y BDR)** mientras que introduzca estos tornillos (ADZ).

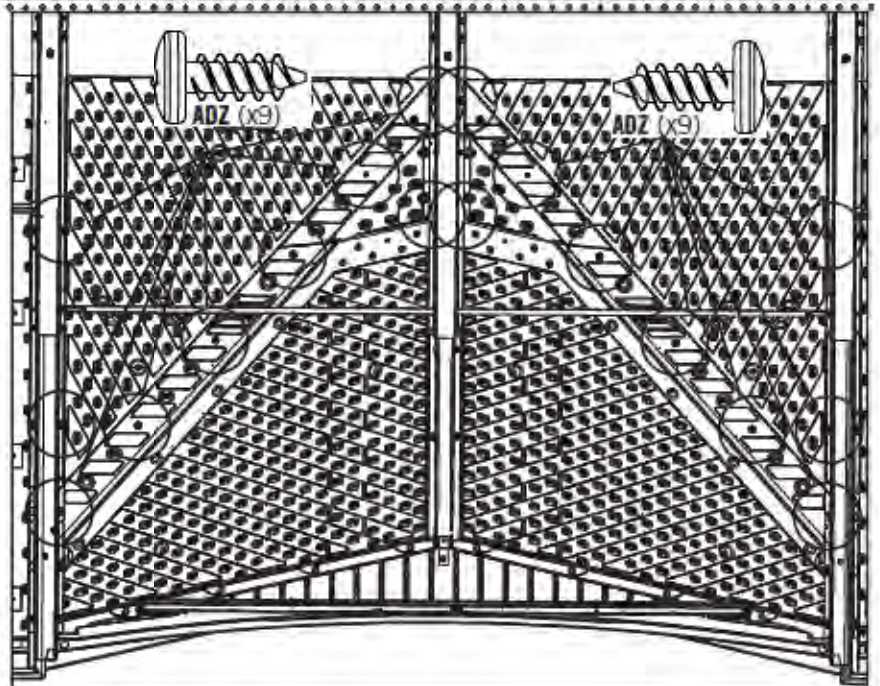

► SECTION 10 (CONTINUED) / SECTION 10 (SUITE) / SECCIÓN 10 (CONTINUACIÓN)

TOOLS AND HARDWARE REQUIRED / OUTILS ET QUINCAILLERIE REQUIS / INSTRUMENTAL Y HERRAJE REQUERIDOS

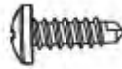

BHJ (x2)

10.32

- Use an electric screwdriver to Insert a **Self Tapping Screw (BHJ)** through the plastic of the Gable and into the Right and Left Door Hinge Tubes at the location shown.
- Employez un perceuse électrique pour insérer une **vis autotaraudeuse (BHJ)** à travers le pignon et dans les charnières des portes aux emplacements illustrés.
- Utilice un taladro eléctrico para introducir un **tornillo auto-roscante (BHJ)** a través la fachada y dentro de las bisagras derecha e izquierda a las ubicaciones ilustradas.

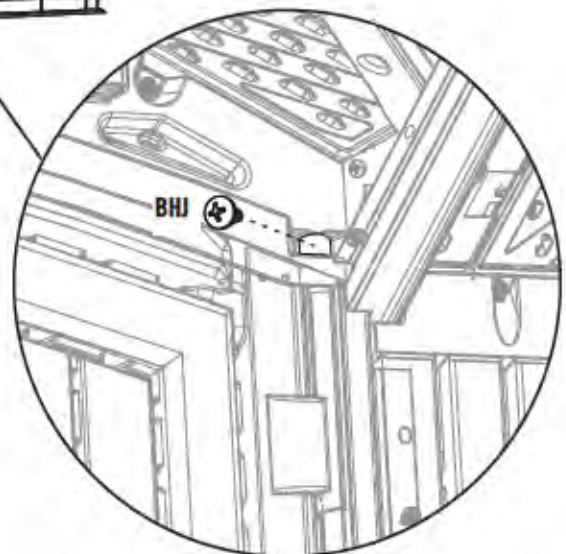
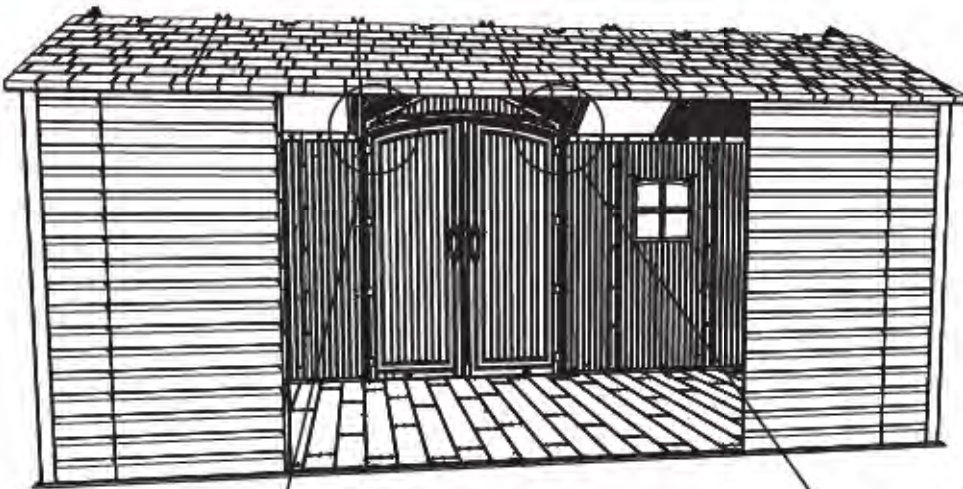

► SECTION 10 (CONTINUED) / SECTION 10 (SUITE) / SECCIÓN 10 (CONTINUACIÓN)

TOOLS AND HARDWARE REQUIRED / OUTILS ET QUINCAILLERIE REQUIS / INSTRUMENTAL Y HERRAJE REQUERIDOS

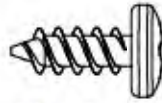

ADZ (x40)

10.33

- Starting at the right, attach the Roof Caps to the shed using the hardware included.
- En commençant au côté droit, attachez les chapeaux à l'abri à l'aide de la quincaillerie incluse.
- Empezando al lado derecho, sujete las cumbreras a la caseta usando el herraje incluido.



Note: The ends of the Roof Caps overlap one another.
Remarque : Les extrémités des chapeaux se chevauchent.
Nota: Los extremos de las cumbreras se solapan.

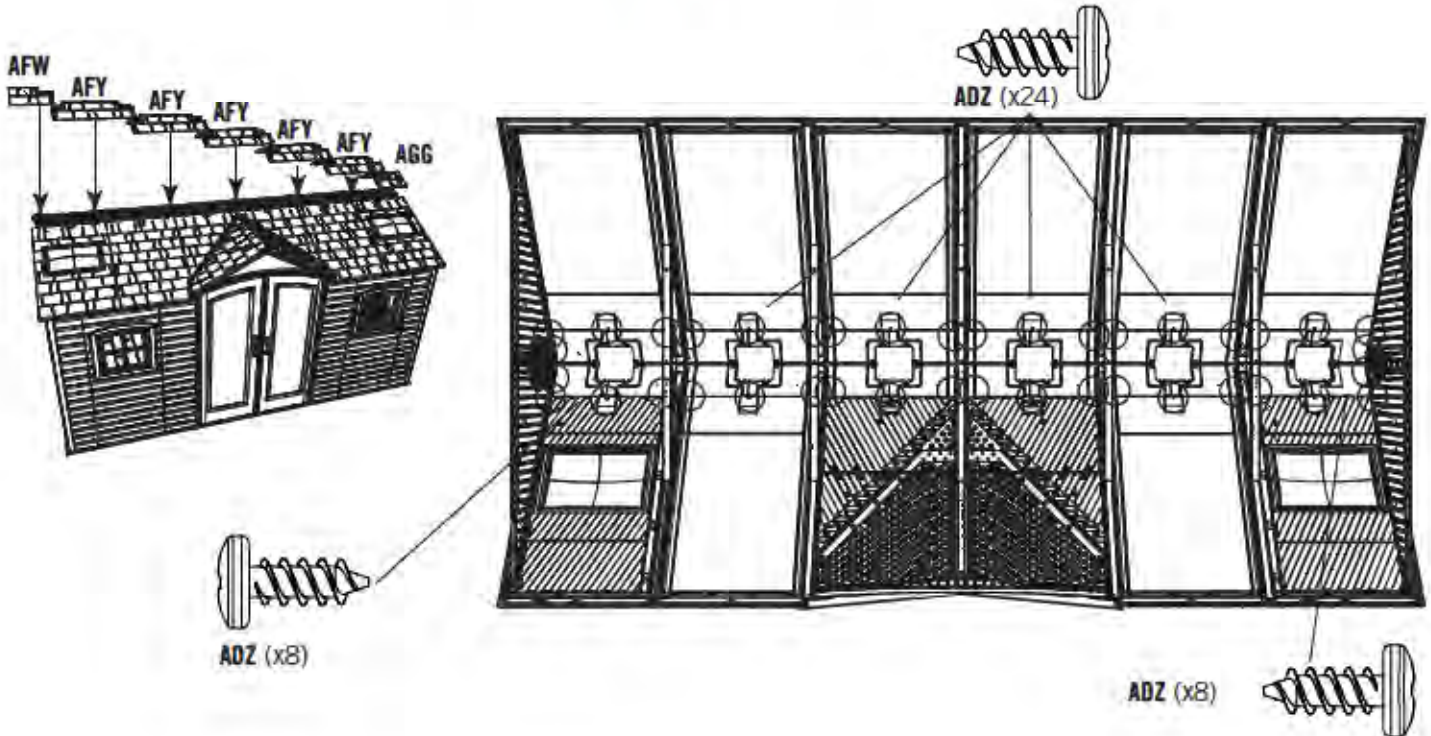

► SECTION 10 (CONTINUED) / SECTION 10 (SUITE) / SECCIÓN 10 (CONTINUACIÓN)

TOOLS AND HARDWARE REQUIRED / OUTILS ET QUINCAILLERIE REQUIS / INSTRUMENTAL Y HERRAJE REQUERIDOS

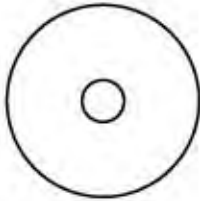

AED (x36)



ADX (x36)

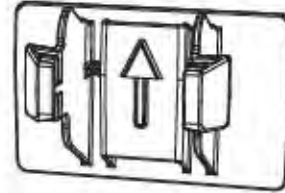

AXX (x2)

10.34



- Fold the **Skylights (AHC)**, and attach them to the Roof using six (6) **Screws (ADX)** and **Washers (AED)** for each Skylight.

- Pliez les **lucarnes (AHC)**, et attachez-les au toit à l'aide de six (6) **vis (ADX)** et **rondelles (AED)** pour chaque lucarne.
- Doble los **tragaluces (AHC)**, y sujételos al tejado usando seis (6) **tornillos (ADX)** y **rondanas (AED)** para cada tragaluz.

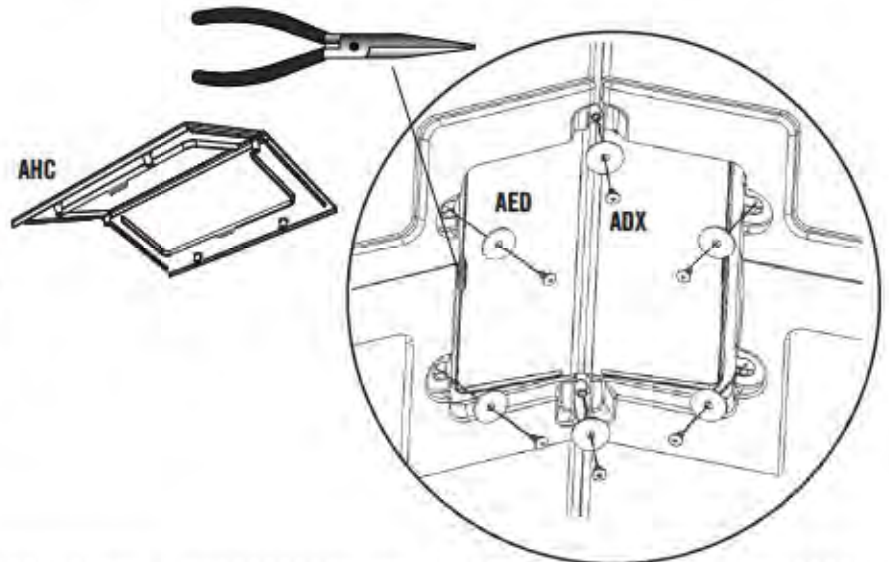
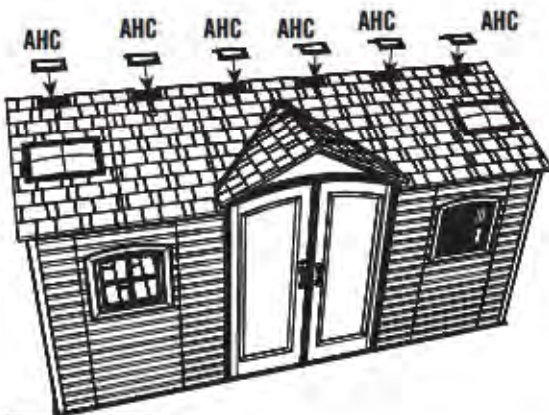

10.35

- Insert the **Clips (AXX)** with the "arrow" facing up.
- Insérez les **clips (AXX)** avec la « flèche » vers le haut.
- Inserte los **clips (AXX)** con la « flecha » hacia arriba.

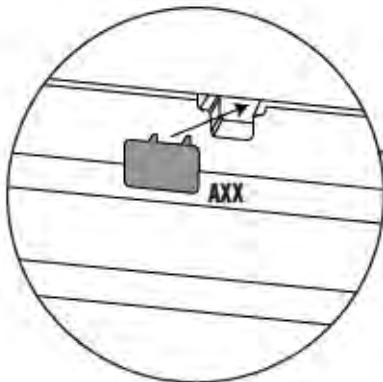
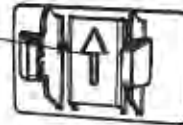

► SECTION 10 (CONTINUED) / SECTION 10 (SUITE) / SECCIÓN 10 (CONTINUACIÓN)

TOOLS AND HARDWARE REQUIRED / OUTILS ET QUINCAILLERIE REQUIS / INSTRUMENTAL Y HERRAJE REQUERIDOS

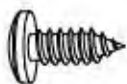

ADX (x4)

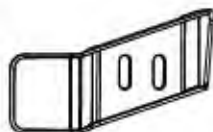

AIM (x1)



AIC (x1)

10.36

- Attach the **Left (AIC)** and **Right (AIM)** Gap Flaps to the corners of the Doors using the hardware included. **These Flaps simply serve to block out light.**
- Attachez les **rabats gauche (AIC)** et **droit (AIM)** aux portes à l'aide de la quincaillerie incluse. **Ces rabats ne servent que pour empêcher la lumière d'entrer.**
- Sujete las **tapas de las puertas izquierda (AIC)** y **derecha (AIM)** a las puertas usando el herraje incluido. **Estas tapas sirven sólo para tapar la luz.**

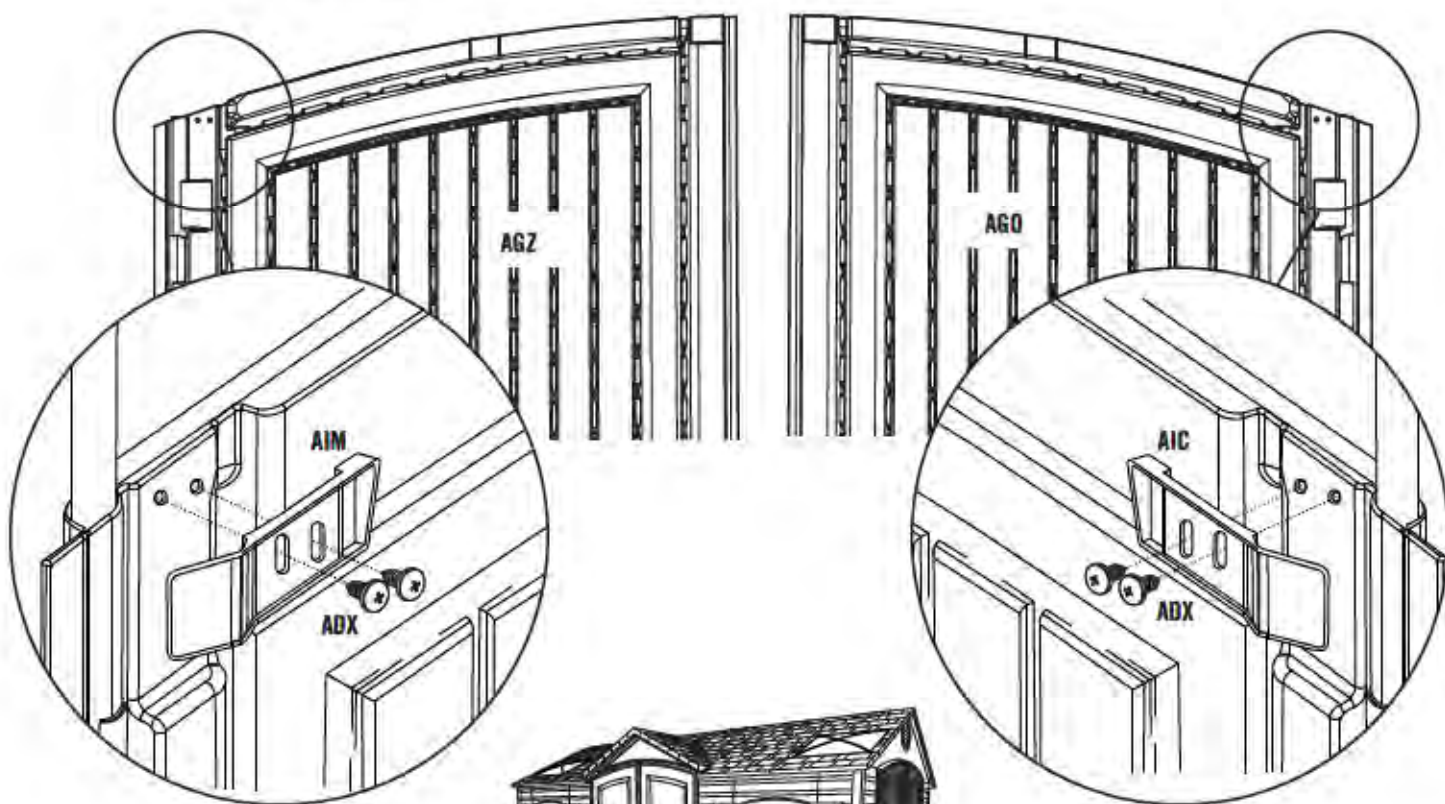

- Do step 10.36 for these Doors only.
- Ne faites l'étape 10.36 que pour ces portes seulement.
- Haga el paso 10.36 sólo para estas puertas.

11

SHUTTER INSTALLATION / INSTALLATION DES VOIETS / INSTALACIÓN DE LAS CONTRAVENTANAS



HARDWARE REQUIRED / QUINCAILLERIE REQUISE / HERRAJE REQUERIDO

Hardware Bag / Sac de quincaillerie / Bolsa de herraje

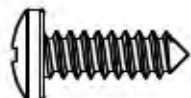

ARV (x16)



PARTS REQUIRED / PIÈCES REQUISES / PIEZAS REQUERIDAS

Plastic Parts / Pièces en plastique / Piezas de plástico

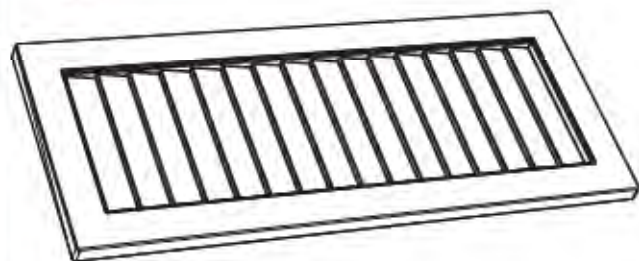

AYI (x4)



TOOLS REQUIRED / OUTILS REQUIS / INSTRUMENTAL REQUERIDO



► SECTION 11 (CONTINUED) / SECTION 11 (SUITE) / SECCIÓN 11 (CONTINUACIÓN)

TOOLS AND HARDWARE REQUIRED / OUTILS ET QUINCAILLERIE REQUIS / INSTRUMENTAL Y HERRAJE REQUERIDOS

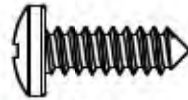

ARV (x1)

11.1

- There are four sets of two screw location indicators. **The measurements are shown to help you locate them.** One by one, insert the **Screws (ARV)** through the indicators from the inside of the shed outward, and attach the **Shutters (AYI)** to the outside of the Wall Panels. **See step 10.2–10.3**
- Il y a quatre groupes de deux indicateurs pour l'emplacement de la vis. **Les mesures indiquent où vous pouvez les trouver.** Une par une, insérez les **vis (ARV)** à travers les indicateurs de l'intérieur à l'extérieur, et attachez les **volets (AYI)** à l'extérieur des panneaux muraux. **Voyez l'étape 10.2 – 10.3.**
- Hay cuatro juegos de dos indicadores para la ubicación del tornillo. **Las medidas indican donde se los pueden hallar.** Uno por uno, inserte los **tornillos (ARV)** por los indicadores del interior al exterior, y sujete las **contraventanas (AYI)** al exterior de los paneles murales. **Vea el paso 10.2–10.3.**

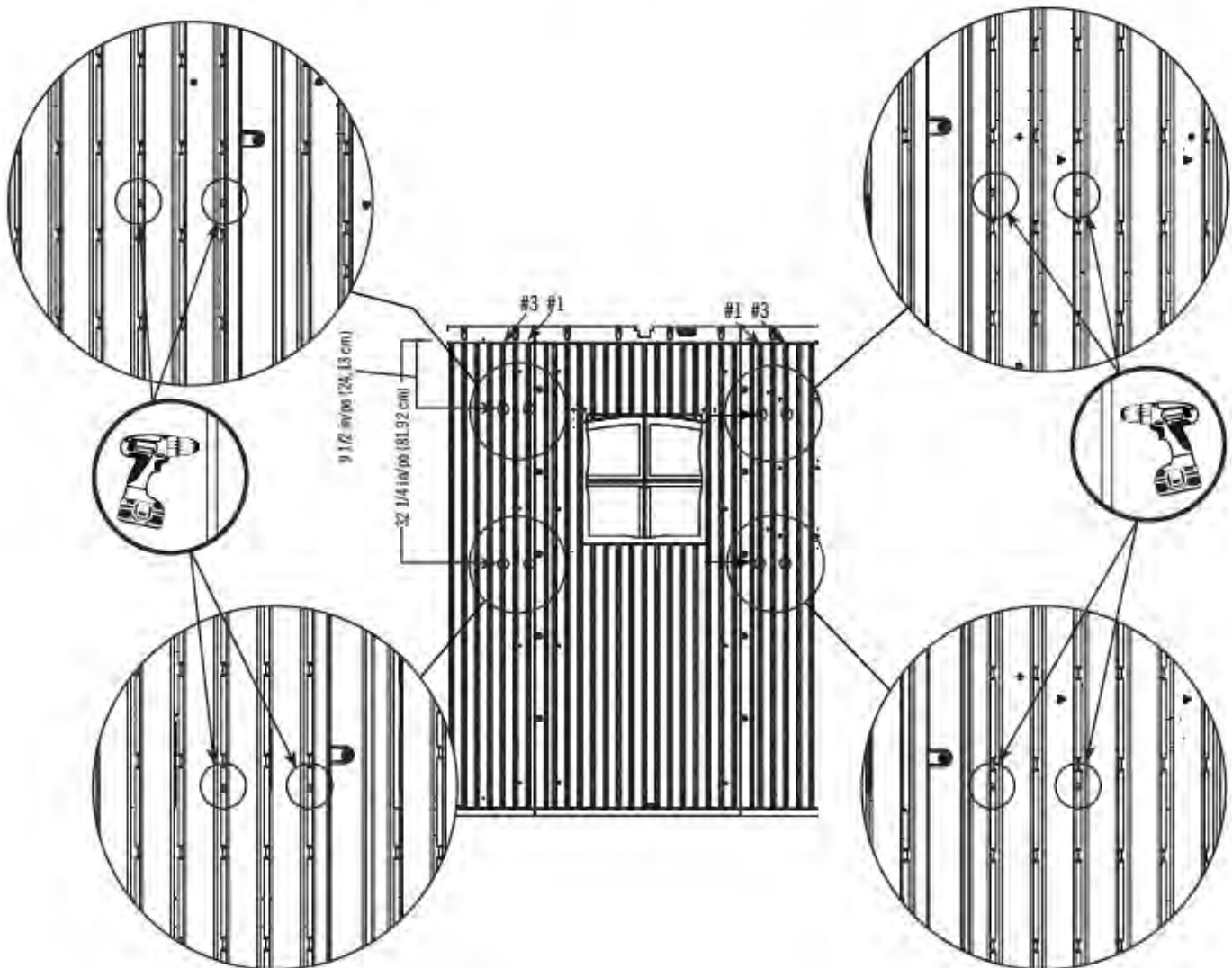

► SECTION 11 (CONTINUED) / SECTION 11 (SUITE) / SECCIÓN 11 (CONTINUACIÓN)

TOOLS AND HARDWARE REQUIRED / OUTILS ET QUINCAILLERIE REQUIS / INSTRUMENTAL Y HERRAJE REQUERIDOS

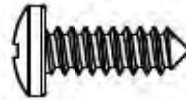

ARV (x15)

11.2



- Align the screw bosses in the **Shutters (AYI)** with the holes in the Wall Panels. Secure the Shutters to the Paneles using the **Screws (ARV)** included.
- Alignez les bossages de montage dans les **volets (AYI)** avec les trous dans les panneaux muraux. Attachez les volets aux panneaux à l'aide des **vis (ARV)** incluses.
- Alinee los huecos de montaje en las **contraventanas (AYI)** con los agujeros en los paneles murales. Sujete las contraventanas a los paneles usando los **tornillos (ARV)** incluidos.

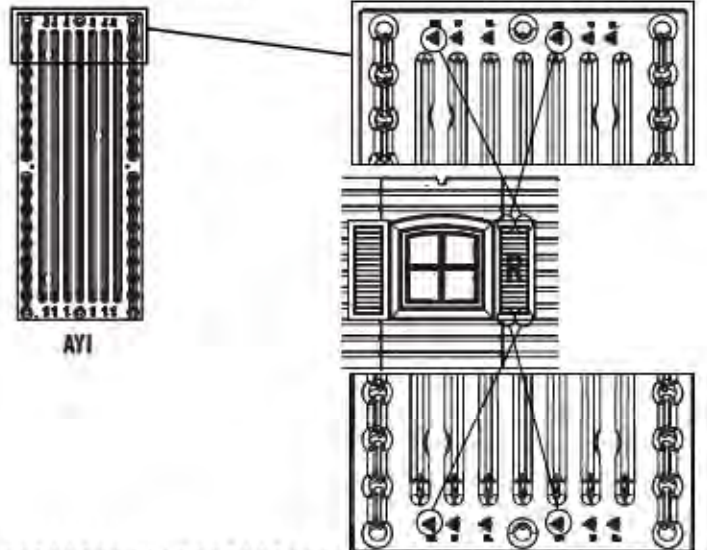

AYI

11.3



- Align the screw bosses in the **Shutters (AYI)** for the left side of the Window with the holes in the Wall Panels. Secure the Shutters to the Paneles using the **Screws (ARV)** included.
- Alignez les bossages de montage dans les **volets (AYI)** pour le côté gauche de la fenêtre avec les trous dans les panneaux muraux. Attachez les volets aux panneaux à l'aide des **vis (ARV)** incluses.
- Alinee los huecos de montaje en las **contraventanas (AYI)** para el lado izquierdo de la ventana con los agujeros en los paneles murales. Sujete las contraventanas a los paneles usando los **tornillos (ARV)** incluidos.

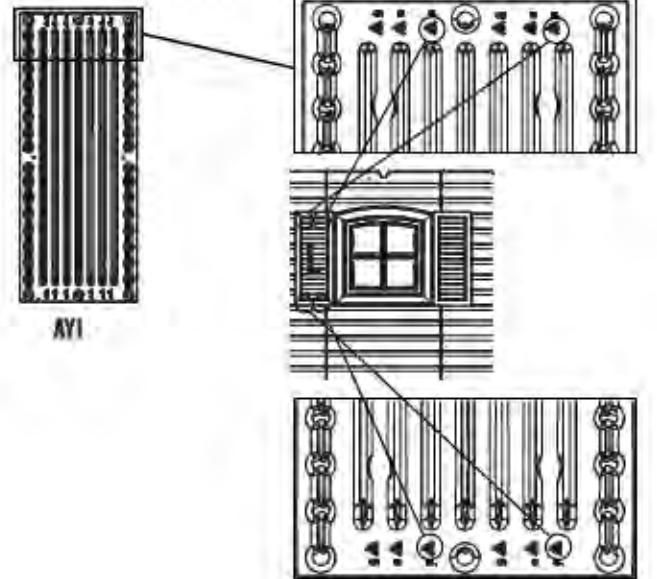

AYI

11.4

- Repeat this section for the second Window.
- Répétez cette section pour la deuxième fenêtre.
- Repita esta sección para la segunda ventana.

12

WINDOW PANE INSTALLATION / INSTALLATION DES CARREUX / INSTALACIÓN DE LAS HOJAS VENTANA



HARDWARE REQUIRED / QUINCAILLERIE REQUISE / HERRAJE REQUERIDO

Hardware Bag / Sac de quincaillerie / Bolsa de herraje

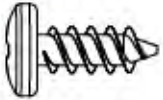

ADZ (x8)

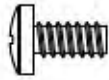

ADY (x2)

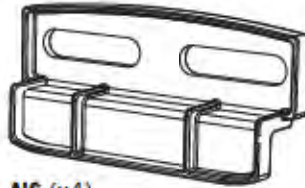

AIS (x4)



PARTS REQUIRED / PIÈCES REQUISES / PIEZAS REQUERIDAS

Plastic Parts / Pièces en plastique / Piezas de plástico



AHE (x2)



TOOLS REQUIRED / OUTILS REQUIS / INSTRUMENTAL REQUERIDO

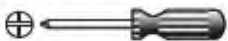

► SECTION 12 (CONTINUED) / SECTION 12 (SUITE) / SECCIÓN 12 (CONTINUACIÓN)

TOOLS AND HARDWARE REQUIRED / OUTILS ET QUINCAILLERIE REQUIS / INSTRUMENTAL Y HERRAJE REQUERIDOS

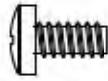

ADY (x1)

12.1

- If you have trouble with this section, follow the code below to view a video on the assembly in this section.
- Si vous avez des problèmes avec cette section, suivez le code en bas pour voir un vidéo sur l'assemblage dans cette section.
- Si tiene problemas con esta sección, siga el código debajo para ver un video sobre el ensamble en esta sección.



<http://go.lifetime.com/8wininstall>

12.2

- Remove the protective backing from both sides of the **Window Pane (AHE)**.
- Enlevez la pellicule protectrice des deux côtés du **carreau (AHE)**.
- Retire el papel protector de las dos caras de la **hoja de ventana (AHE)**.



12.3

- With the curved edge at the top and facing toward you, slide the Window Pane down into the opening.
- Avec le bord courbé vers le haut et faisant face de vous, glissez le carreau en place.
- Con el borde curvado hacia el alto y haciendo face vers vous, glissez la hoja en place.

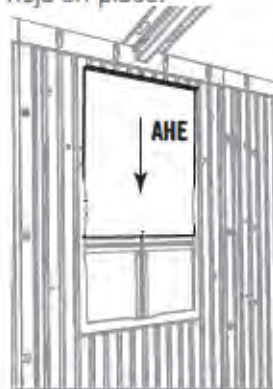

12.4

- Insert a **Screw (ADY)** into the hole at the bottom of the Window Pane. **This helps keep the Window up when open.**
- Insérez une **vis (ADY)** dans le trou au bord inférieur de la fenêtre. **Cela aide à garder le carreau en place lorsqu'il est ouvert.**
- Introduzca un **tornillo (ADY)** en el agujero al borde inferior de la ventana. **Esto ayuda a prevenir la cierre de la Hoja.**

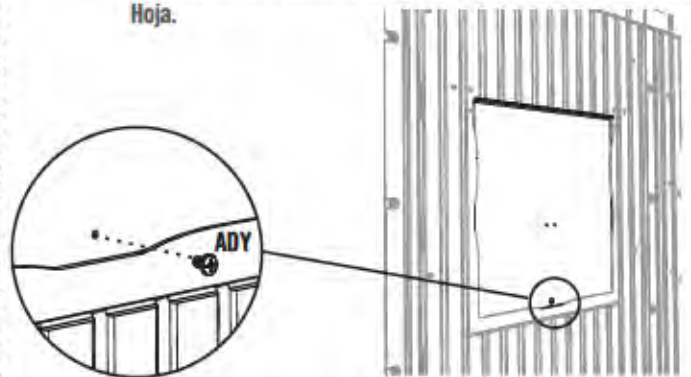

► SECTION 12 (CONTINUED) / SECTION 12 (SUITE) / SECCIÓN 12 (CONTINUACIÓN)

TOOLS AND HARDWARE REQUIRED / OUTILS ET QUINCAILLERIE REQUIS / INSTRUMENTAL Y HERRAJE REQUERIDOS

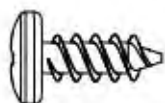

ADZ (x4)

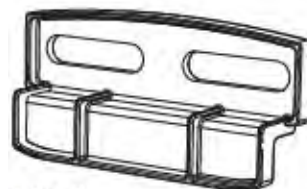

AIS (x2)

12.5

- Attach the two (2) **Window Latches (ADY)** at the top corners of the Panel opening. **The Latch should move freely.**
- Attachez les deux (2) **loquets (ADY)** aux angles supérieurs de l'ouverture du panneau. **Le loquet doit se déplacer librement.**
- Sujete los dos (2) **cerrojos (ADY)** a las esquinas superiores de la abertura del panel. **El cerrojo debe mover libremente.**

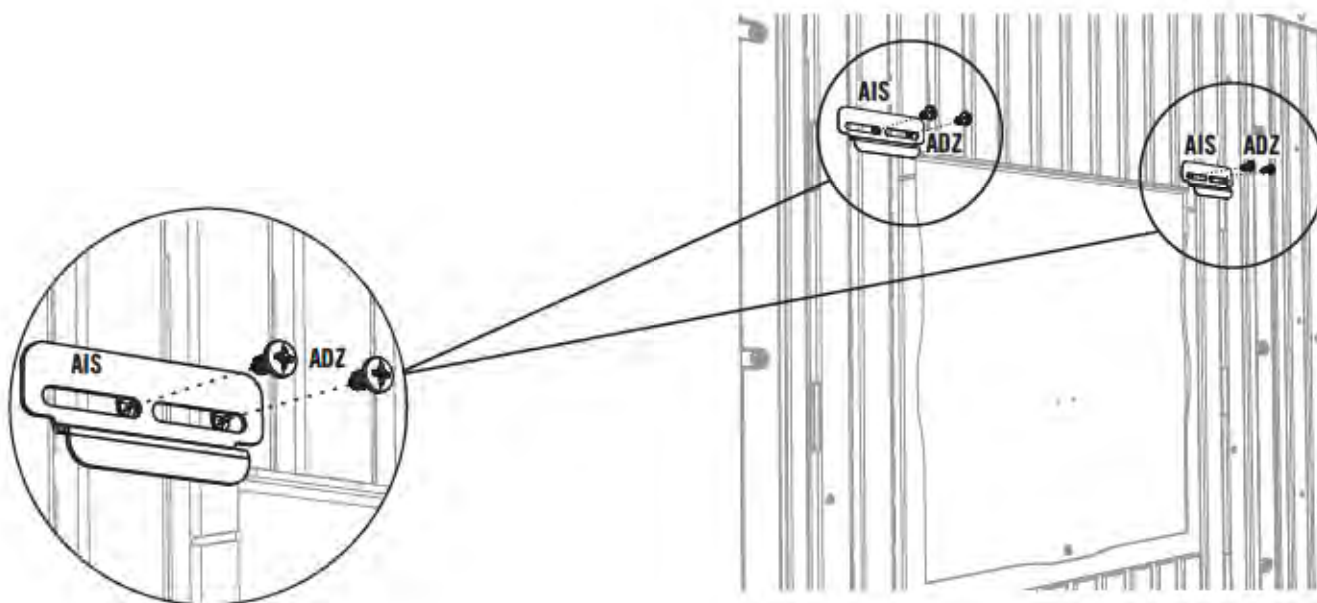

13

PEGBOARD STRIP INSTALLATION / INSTALLATION DE L'ORGANISEUR D'OUTILS / INSTALACIÓN DEL ORGANIZADOR DE HERRAMIENTAS



HARDWARE REQUIRED / QUINCAILLERIE REQUISE / HERRAJE REQUERIDO

Hardware Bag / Sac de quincaillerie / Bolsa de herraje

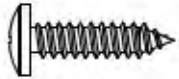

ADW (x10)

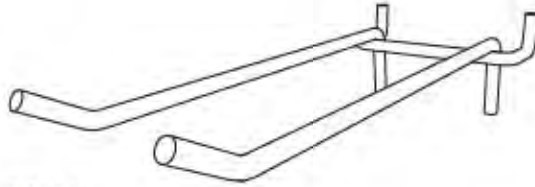

AIG (x1)



AUJ (x2)

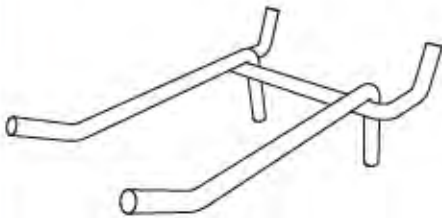

AIF (x1)



AIH (x3)

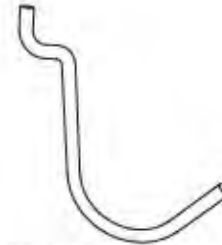

AII (x3)



PARTS REQUIRED / PIÈCES REQUISES / PIEZAS REQUERIDAS

Plastic Parts / Pièces en plastique / Piezas de plástico

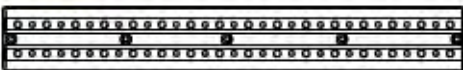

AFU (x2)



TOOLS REQUIRED / OUTILS REQUIS / INSTRUMENTAL REQUERIDO



► SECTION 13 (CONTINUED) / SECTION 13 (SUITE) / SECCIÓN 13 (CONTINUACIÓN)

TOOLS AND HARDWARE REQUIRED / OUTILS ET QUINCAILLERIE REQUIS / INSTRUMENTAL Y HERRAJE REQUERIDOS

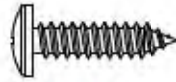

ADW (x10)

13.1

• If you have trouble with this section, follow the code below to view a video on the assembly in this section.

• Si vous avez des problèmes avec cette section, suivez le code en bas pour voir un vidéo sur l'assemblage dans cette section.

• Si tiene problemas con esta sección, siga el código debajo para ver un video sobre el ensamble en esta sección.

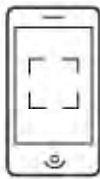

<http://go.lifetime.com/pegboard>

13.2

• Attach the **Pegboard Strip (AFU)** to a Wall Panel using five (5) **Screws (ADW)**. Avoid Window Wall Panels.

• Attachez l'**organisateur d'outils (AFU)** au panneau mural à l'aide de cinq (5) **vis (ADW)**. Évitez les panneaux pour la fenêtre.

• Sujete el **organizador de herramientas (AFU)** a un panel de pared usando cinco (5) **tornillos (ADW)**. Evite los paneles para la ventana.



AFU

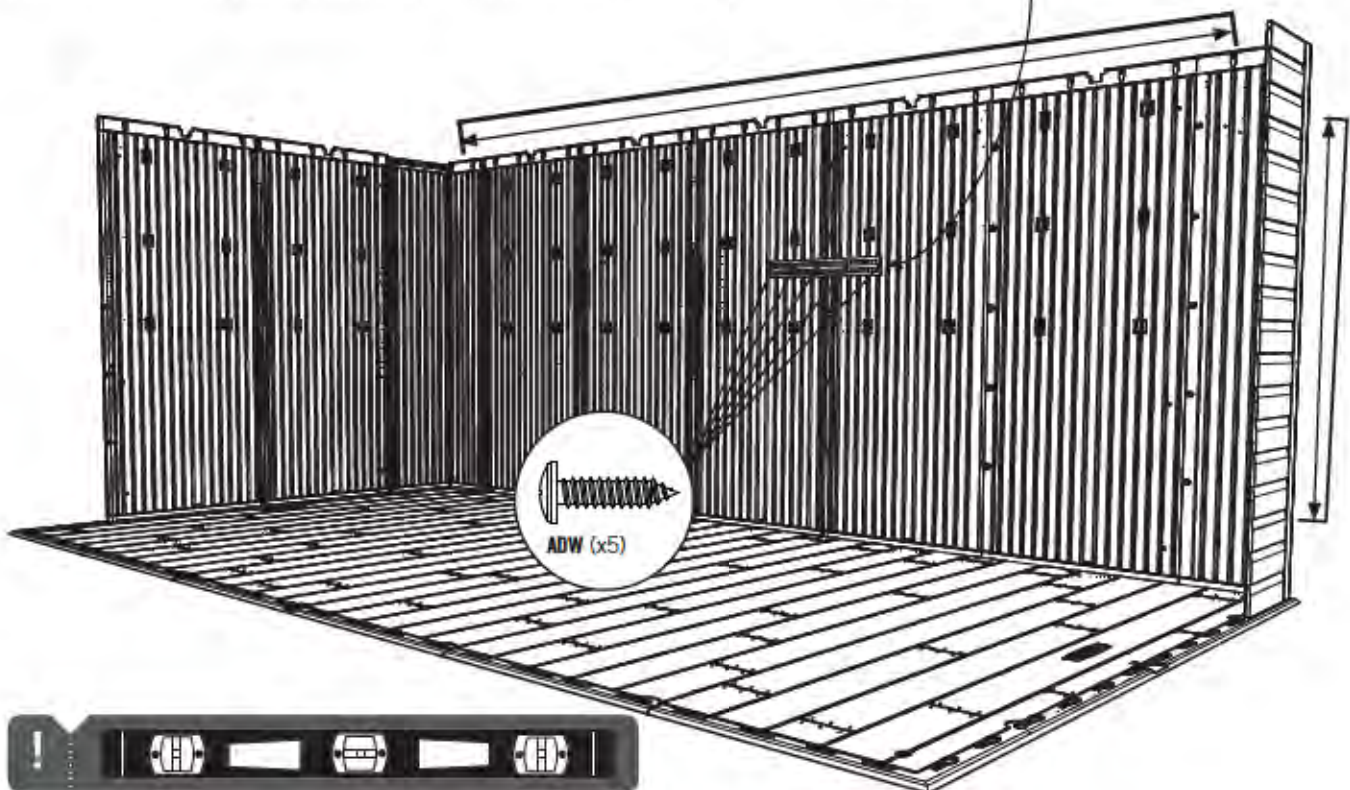

► SECTION 13 (CONTINUED) / SECTION 13 (SUITE) / SECCIÓN 13 (CONTINUACIÓN)

TOOLS AND HARDWARE REQUIRED / OUTILS ET QUINCAILLERIE REQUIS / INSTRUMENTAL Y HERRAJE REQUERIDOS

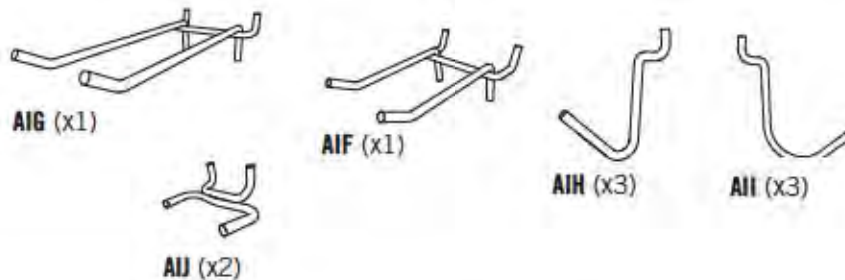

13.3

- Insert the various **Hooks (AIF, AIG, AIH, AII, AIJ)** as shown.
- Insérez les divers **Crochets (AIF, AIG, AIH, AII, AIJ)** comme illustré.
- Inserte los varios **Ganchos (AIF, AIG, AIH, AII, AIJ)** como se muestra.

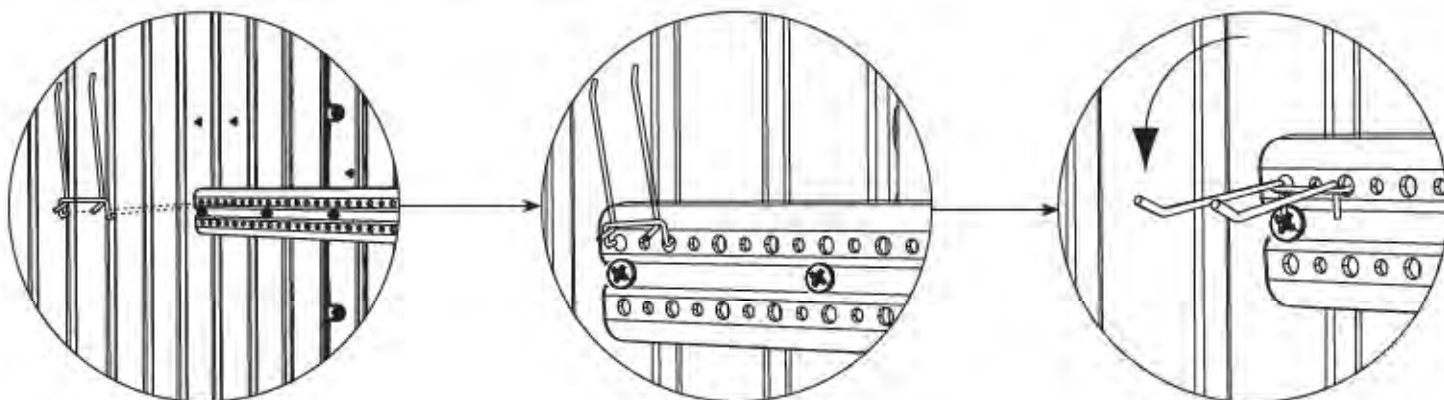

13.4

- Repeat this section for the second Pegboard Strip.
- Répétez cette section pour le deuxième organisateur d'outils.
- Repita esta sección para el segundo organizador de herramientas.

14

TOOL CORRAL INSTALLATION / INSTALLATION DU CORRAL D'OUTILS / INSTALACIÓN DEL CORRAL DE HERRAMIENTAS



HARDWARE REQUIRED / QUINCAILLERIE REQUISE / HERRAJE REQUERIDO

Hardware Bag / Sac de quincaillerie / Bolsa de herraje

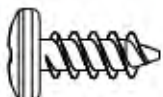

ADZ (x2)



ADX (x8)



PARTS REQUIRED / PIÈCES REQUISES / PIEZAS REQUERIDAS

Metal Parts / Pièces en métal / Piezas de metal

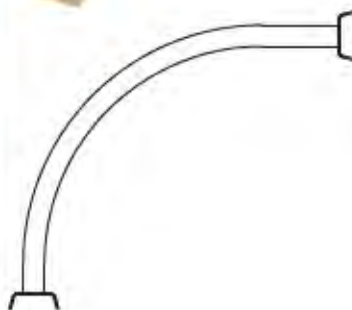

AYG (x1)



TOOLS REQUIRED / OUTILS REQUIS / INSTRUMENTAL REQUERIDO



► SECTION 14 (CONTINUED) / SECTION 14 (SUITE) / SECCIÓN 14 (CONTINUACIÓN)

TOOLS AND HARDWARE REQUIRED / OUTILS ET QUINCAILLERIE REQUIS / INSTRUMENTAL Y HERRAJE REQUERIDOS

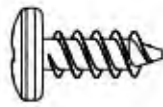

ADZ (x2)



ADX (x8)

14.1

- Place the **Tool Corral (AYG)** in the desired corner at the desired height. **The height you choose depends on the length of the tools you would like to "corral".**
- Posez le **Corral d'outils (AYG)** dans un encoignure à l'hauteur désirée. **L'hauteur que vous choisissez dépend de la longueur des outils que vous voudriez placer ici.**
- Coloque el **Corral de herramientas (AYG)** en un rincón a la altura deseada. **La altura que escoge depende del longitud de las herramientas que le gustaría colocar aquí.**

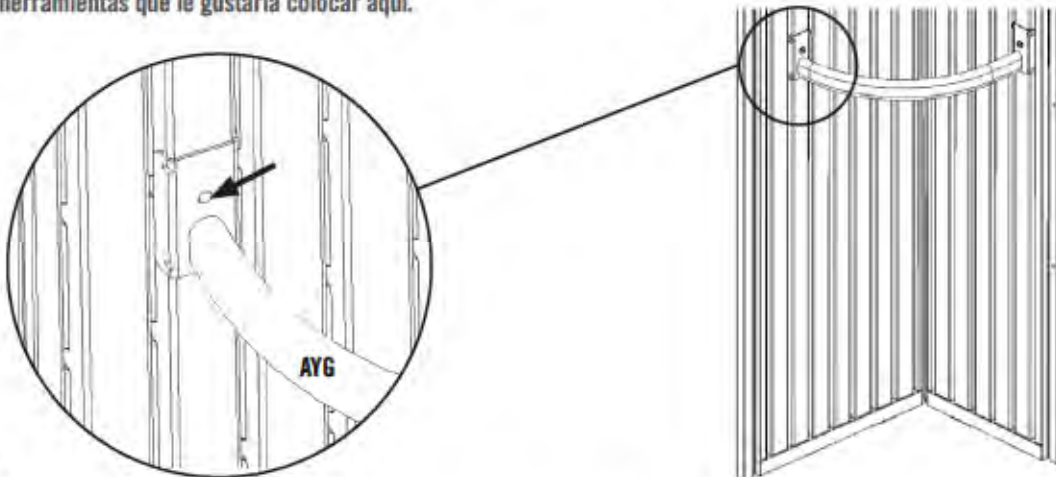

14.2

- Use a hand screwdriver to insert **Screws (ADX & ADZ)** at the locations shown. **Repeat this step for the other end.**
- Utilisez un tournevis manuel pour insérer les vis (**ADX et ADZ**) aux emplacements illustrés. **Répétez cette étape pour l'autre extrémité.**
- Use un destornillador manual para insertar **tornillos (ADX y ADZ)** a las ubicaciones indicadas. **Repita este paso para el otro extremo.**

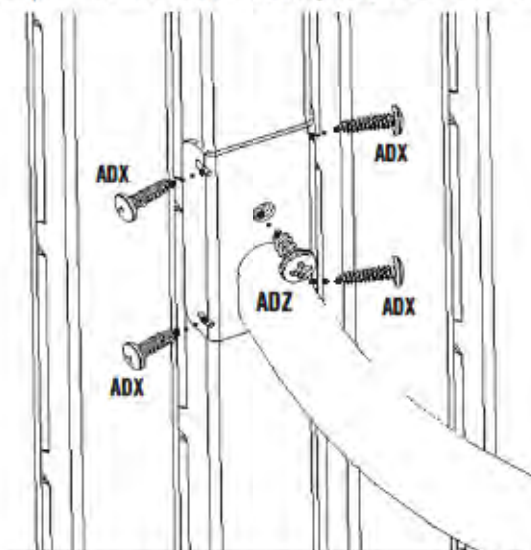

15

DOOR ALIGNMENT / ALIGNEMENT DES PORTES / ALINEACIÓN DE LAS PUERTAS



HARDWARE REQUIRED / QUINCAILLERIE REQUISE / HERRAJE REQUERIDO

**NO HARDWARE REQUIRED FOR THIS SECTION
AUCUNE QUINCAILLERIE REQUISE POUR CETTE SECTION
NINGÚN HERRAJE REQUERIDO PARA ESTA SECCIÓN**



PARTS REQUIRED / PIÈCES REQUISES / PIEZAS REQUERIDAS

Wood Parts / Pièces en bois / Piezas de madera



AIX (x4)



TOOLS REQUIRED / OUTILS REQUIS / INSTRUMENTAL REQUERIDO



**7/16 in/po
(11 mm)**

► SECTION 15 (CONTINUED) / SECTION 15 (SUITE) / SECCIÓN 15 (CONTINUACIÓN)

TOOLS AND HARDWARE REQUIRED / OUTILS ET QUINCAILLERIE REQUIS / INSTRUMENTAL Y HERRAJE REQUERIDOS



AIX (x4)

15.1

- If one or both of the Doors scrape the floor when closing or are not aligned at the top, follow these steps to correct them:
- Si une ou les deux portes frotter en se ferment ou l'une est plus bas que l'autre, suivez ces étapes pour les corriger :
- Si una de las dos puertas se roza con el Piso al cerrarlas o no está nivelada a la parte superior, siga estos pasos para corregirla:



15.2

- If the Right Door scrapes the Floor or is lower than the Left Door, insert a **Shim (AIX)** under the Floor directly under the hinge of the Right Door. If necessary, repeat for the Left Door until both Doors are level and do not scrape.
- Si la porte droite frotte en se ferment ou est plus bas que la porte gauche, insérez une **cale (AIX)** sous le plancher et directement sous la charnière de la porte droite. S'il est nécessaire, répétez cette étape pour la porte gauche jusqu'à ce que les deux portes soient nivelées et ne frottent pas.
- Si la puerta derecha se roza con el piso o es más bajo que la izquierda, inserte una **cuña (AIX)** debajo el piso y directamente debajo la bisagra de la puerta derecha. Si es necesario, repita este paso para la puerta izquierda o hasta que las dos puertas estén niveladas y no se rocen.

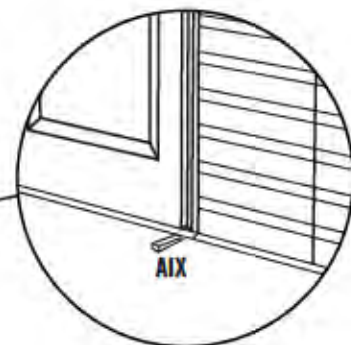
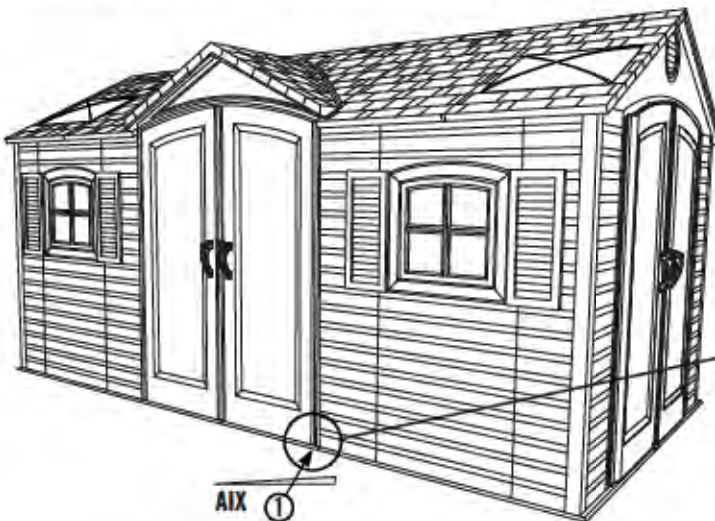



HARDWARE REQUIRED / QUINCAILLERIE REQUISE / HERRAJE REQUERIDO

NO HARDWARE OR PARTS INCLUDED FOR THIS SECTION
AUCUNE QUINCAILLERIE OU PIÈCE INCLUSE POUR CETTE SECTION
NINGÚN HERRAJE O PIEZA INCLUIDO PARA ESTA SECCIÓN



PARTS REQUIRED / PIÈCES REQUISES / PIEZAS REQUERIDAS

NO HARDWARE OR PARTS INCLUDED FOR THIS SECTION
AUCUNE QUINCAILLERIE OU PIÈCE INCLUSE POUR CETTE SECTION
NINGÚN HERRAJE O PIEZA INCLUIDO PARA ESTA SECCIÓN



TOOLS REQUIRED / OUTILS REQUIS / INSTRUMENTAL REQUERIDO



7/16 in/po (11 mm)



5/16" (8 mm) Wood Drill Bit
 Foret à bois de 8mm
 Broca para madera de 8 mm



5/16" (8 mm) Masonry Drill Bit
 Foret à maçonnerie de 8 mm
 Broca para albañilería de 8 mm

► SECTION 16 (CONTINUED) / SECTION 16 (SUITE) / SECCIÓN 16 (CONTINUACIÓN)

FOR A CONCRETE PLATFORM / POUR UNE PLATE-FORME EN BÉTON / PARA UNA PLATAFORMA DE CONCRETO



5/16 in/po
(8 mm)



16.1

- If you plan on anchoring your shed to a concrete platform, you must purchase the correct anchoring hardware. We recommend using a hammer drill, 5/16" (8 mm) masonry bit, twelve (12) 3/8" x 2" (10 mm x 5 cm) Concrete Screws and twelve (12) 3/8" x 1" (10 mm x 2,5 cm) Fender Washers.
- Si vous désirez ancrer votre abri à une plate-forme en béton, il faut acheter la quincaillerie d'ancrage correcte. Nous recommandons que vous utilisiez une perceuse de percussion, un foret à maçonnerie de 8 mm, douze (12) vis d'ancrage à béton de 10 mm x 5 cm (3/8 po x 2 po) et douze (12) rondelles de protection de 10 mm x 2,5 cm (3/8 po x 1 po).
- Si desea anclar su caseta a una plataforma hecho de concreto, es necesario comprar los elementos de anclaje correctos. Recomendamos que use un martillo perforador, broca de albañilería de 8 mm, doce (12) tornillos de anclaje para concreto de 10 mm x 5 cm (3/8 in x 2 in) y doce (12) rondanas de protección de 10 mm x 2,5 cm (3/8 in x 1 in).



- Do not exceed a 3/8" (10 mm) diameter screw. Refer to your local hardware store for this hardware.
- Ne dépassez pas un diamètre de 10 mm (3/8 po). Votre quincaillerie du coin aura ces accessoires.
- No exceda un diámetro de 10 mm (3/8 in). Refiérase a su ferretería local para obtener este herraje.

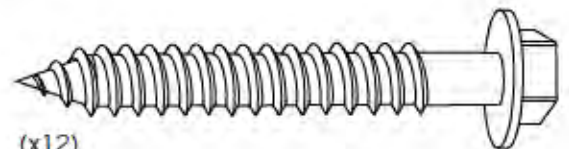
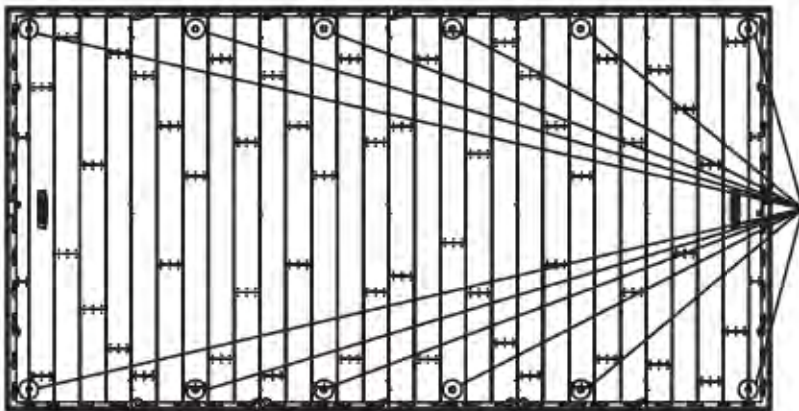

(x12)

(Not included) (Pas incluses) (No incluidos)

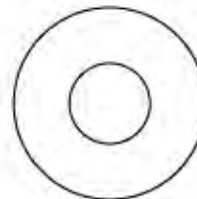

(x12)

(Not included) (Pas incluses) (No incluidos)



WARNING / AVERTISSEMENT / ADVERTENCIA



- Failure to anchor the shed may result in property damage and/or personal injury.
- Si vous n'ancrez pas votre abri, des dommages à la propriété et/ou des blessures peuvent en résulter.
- No anclar la caseta puede resultar en daños a la propiedad y/o en lesiones personales.

▶ SECTION 16 (CONTINUED) / SECTION 16 (SUITE) / SECCIÓN 16 (CONTINUACIÓN)

FOR A CONCRETE PLATFORM / POUR UNE PLATE-FORME EN BÉTON / PARA UNA PLATAFORMA DE CONCRETO



5/16 in/po
(8 mm)



7/16 in/po
(11 mm)

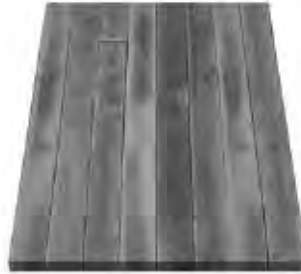

16.1

- If you plan on anchoring your shed to a wood platform, you must purchase the correct anchoring hardware. We recommend using a drill, 5/16" (8 mm) drill bit, twelve (12) 3/8" x 1 1/2" (10 mm x 4 cm) Lag Screws and twelve (12) 3/8" x 1" (10 mm x 2,5 cm) Fender Washers.
- Si vous désirez ancrer votre abri à une plate-forme en bois, il faut acheter la quincaillerie d'ancrage correcte. Nous recommandons que vous utilisiez une perceuse électrique, un foret de 8 mm, douze (12) vis de retard de 10 mm x 4 cm (3/8 po x 1 1/2 po), et douze (12) rondelles de protection de 10 mm x 2,5 cm (3/8 po x 1 po).
- Si desea anclar su caseta a una plataforma hecho de madera, es necesario comprar los elementos de anclaje correctos. Recomendamos que use un taladro eléctrico, una broca de 8 mm, doce (12) tornillos para madera de 10 mm x 4 cm (3/8 in x 1 1/2 in) y doce (12) rondanas de protección de 10 mm x 2,5 cm (3/8 in x 1 in).



- Do not exceed a 3/8" (10 mm) diameter screw. Refer to your local hardware store for this hardware.
- Ne dépassez pas un diamètre de 10 mm (3/8 po). Votre quincaillerie du coin aura ces accessoires.
- No exceda un diámetro de 10 mm (3/8 in). Refiérase a su ferretería local para obtener este herraje.

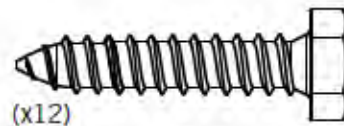
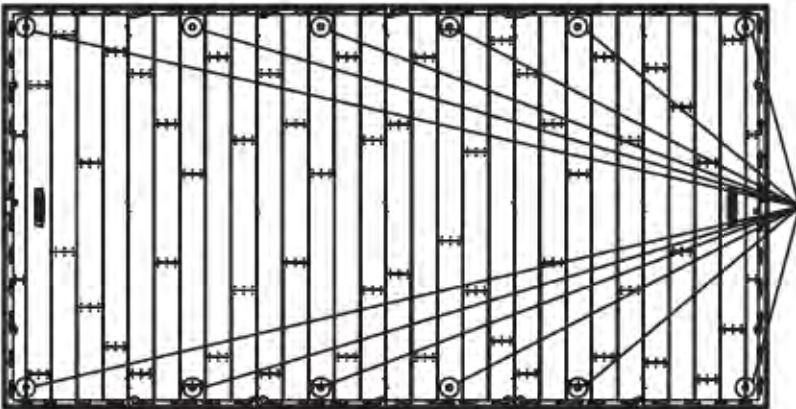

(x12)

(Not included) (Pas incluses) (No incluidas)

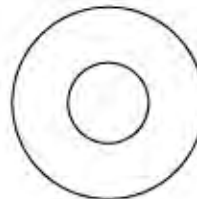

(x12)

(Not included) (Pas incluses) (No incluidas)



WARNING / AVERTISSEMENT / ADVERTENCIA



- Failure to anchor the shed may result in property damage and/or personal injury.
- Si vous n'ancrez pas votre abri, des dommages à la propriété et/ou des blessures peuvent en résulter.
- No anclar la caseta puede resultar en daños a la propiedad y/o en lesiones personales.





CLEANING & CARE

Congratulations on your Lifetime® product purchase. By following the instructions below, your new Lifetime product should provide you with years of service and enjoyment.

The polyethylene panels are stain- and solvent-resistant. Most stains can be removed using a mild soap and a soft-bristled brush. Abrasive cleaning materials may scratch the plastic and are not recommended. Repair scratches or rust spots on the metal by sanding the affected area lightly; using a rust preventative spray primer; and finally, spraying with a high-gloss spray enamel paint. Avoid placing a direct heat source on or near surfaces unless using a heat barrier.



NETTOYAGE ET ENTRETIEN

Nous vous félicitons d'avoir acheté ce produit Lifetime®. En suivant les instructions ci-dessous, votre nouvel produit Lifetime devrait vous fournir des années de service et de plaisir.

Les murs et les étagères en polyéthylène sont résistants aux tâches et solvants de nettoyage. Pour les nettoyer, servez-vous d'un savon doux et d'une brosse douce. Les produits abrasifs de nettoyage risquent d'égratigner le plastique et ne sont pas recommandés. Pour réparer les égratignures ou tâches de rouille sur le métal, frottez légèrement l'endroit affecté ou papier de verre, puis passez un couche de produit vaporisant préventif et enfin vaporisez une peinture émail brillant élevé. Évitez de placer une source de chaleur directe sur ou près des surfaces, ou protégez-les à l'aide d'une protection contre la chaleur.



LIMPIEZA Y CUIDADO

Felicidades por la compra de su producto Lifetime®. Al seguir las siguientes instrucciones, su nuevo producto Lifetime le brindará años de servicio y satisfacción.

Los paneles de polietileno son resistentes a las manchas y solventes. La mayoría de las manchas puede removerse usando un jabón suave y un cepillo de cerdas suaves. Los materiales abrasivos para limpieza pueden rayar el plástico y no se recomiendan. Repare rayones o manchas de óxido en el metal, lijando suavemente la parte afectada; usando un aerosol preventivo de óxido y finalmente, rociando con una pintura de esmalte brillante. Evite poner una fuente de calor directa en o cerca de las superficies a menos que utilice una barrera de calor.



REGISTER YOUR PRODUCT ONLINE AT WWW.LIFETIME.COM

At Lifetime®, we are committed to providing innovative and quality products. While registering, you will have the opportunity to give us your feedback. Your input is valuable to us.

- You can also opt in to receive new product notifications or promotions.
- In the unlikely event of a product recall or safety modification, your registration provides the information we need to notify you directly.
- Registration is fast, easy, and completely voluntary.

LIFETIME'S PROMISE TO YOU:

Maintaining your privacy is our long-standing policy at Lifetime®. And you can rest assured that Lifetime® will not sell or provide your personal data to other third parties, or allow them to use your personal data for their own purposes.

We invite you to read our privacy policy at www.lifetime.com

REGISTER today!



ENREGISTREZ VOTRE PRODUIT EN LIGNE CHEZ NOUS À WWW.LIFETIME.COM

Chez Lifetime®, nous nous engageons à fournir des produits innovateurs de qualité. Lors de votre inscription, vous aurez l'occasion de nous faire parvenir vos commentaires. Votre opinion est importante pour nous.

- Vous pouvez également choisir de recevoir des avis ou des promotions dans le cadre de nouveaux produits.
- Dans l'éventualité improbable d'un rappel ou d'un avis de sécurité, votre inscription fournit les renseignements nécessaires nous permettant de communiquer avec vous.
- L'inscription est rapide, facile et complètement volontaire.

LA PROMESSE DE LIFETIME :

Conserver votre confidentialité est notre politique de longue date chez Lifetime®. Vous pouvez donc être rassuré par le fait que Lifetime® ne vendra pas ou ne fournira pas vos données personnelles à des tiers, et ne leur permettra pas d'utiliser vos données personnelles à leurs propres fins.

Nous vous invitons à lire notre politique de confidentialité à www.lifetime.com

INSCRIVEZ-VOUS aujourd'hui même !



REGISTRE SU PRODUCTO EN LÍNEA EN WWW.LIFETIME.COM

En Lifetime®, estamos comprometidos a ofrecer productos innovadores y de calidad. Al registrarse, usted tendrá la oportunidad de darnos su retroalimentación. Su información es valiosa para nosotros.

- También puede optar por recibir nuestras notificaciones o promociones.
- En el caso improbable de que el producto tenga que salir del mercado o que sufra alguna modificación, su registro provee la información que necesitamos para notificarle directamente.
- El registro es rápido, fácil y completamente voluntario.

LA PROMESA DE LIFETIME® PARA USTED:

Mantener su privacidad es nuestra política permanente en Lifetime®. Y puede estar seguro que Lifetime® no venderá ni dará sus datos personales a terceros, ni les permitirá usar sus datos personales para fines propios.

Lo invitamos a leer nuestra política de privacidad en www.lifetime.com

¡REGÍSTRESE hoy mismo!



10-YEAR LIMITED FACTORY WARRANTY

THE MANUFACTURER RESERVES THE RIGHT TO MAKE SUBSTITUTIONS TO WARRANTY CLAIMS IF PARTS ARE UNAVAILABLE OR OBSOLETE.

1. Lifetime outdoor sheds are warranted to the original purchaser to be free from defects in material or workmanship for a period of ten years from the date of original retail purchase. The word "defects" is defined as imperfections that impair the use of the product. Defects resulting from misuse, abuse or negligence will void this warranty. This warranty does not cover defects due to improper installation, alteration or accident. This warranty does not cover damage caused by vandalism, rusting, "acts of nature" or any other event beyond the control of the manufacturer.
2. This warranty is nontransferable and is expressly limited to the repair or replacement of defective product. If the product is defective within the terms of this warranty, Lifetime Products, Inc. will repair or replace defective parts at no cost to the purchaser. Shipping charges to and from the factory or distribution center are not covered and are the responsibility of the purchaser. Labor charges and related expenses for removal, installation or replacement of the shed or its components are not covered under this warranty.
3. This warranty does not cover scratching or scuffing of the product that may result from normal usage. In addition, defects resulting from intentional damage, negligence, unreasonable use or hanging from the truss will void this warranty.
4. Liability for incidental or consequential damages is excluded to the extent permitted by law. While every attempt is made to embody the highest degree of safety in all equipment, freedom from injury cannot be guaranteed. The user assumes all risk of injury resulting from the use of this product. All merchandise is sold on this condition, and no representative of the company may waive or change this policy.
5. This product is not intended for institutional or commercial use; Lifetime Products, Inc. does not assume any liability for such use. Institutional or commercial use will void the warranty.
6. Our goods come with guarantees that cannot be excluded under the Australian Consumer Law. You are entitled to a replacement or refund for a major failure and for compensation for any other reasonably foreseeable loss or damage. You are also entitled to have the goods repaired or replaced if the goods fail to be of acceptable quality and the failure does not amount to a major failure.
7. This warranty is expressly in lieu of all other warranties, expressed or implied, including warranties of merchantability or fitness for use to extent permitted by Federal and state law. Neither Lifetime Products, Inc., nor any representative assumes any other liability in connection with this product. This warranty gives you specific legal rights, and you may also have other rights which vary from state to state.

PLEASE INCLUDE YOUR DATED SALES RECEIPT AND PHOTOGRAPHS OF DAMAGED PARTS.

REPORT PRODUCT DEFECTS IN WRITING TO:
Lifetime Products, Inc., PO Box 160010 Clearfield, UT 84016-0010
or call 1-800-225-3865 M-F 7 a.m. to 5 p.m. MST.

REGISTER YOUR PRODUCT FOR QUICKER CUSTOMER SERVICE.

Visit www.lifetime.com or call 1-800-225-3865 to register your product today.

FOR INTERNATIONAL WARRANTY CLAIMS:

All warranty claims must be accompanied by a sales receipt. Report all warranty claims in writing to your regional sales support representative. Please include your dated sales receipt and photographs of damaged parts.
To identify the representative for your region, please visit: www.lifetime.com/international



www.lifetime.com



GARANTIE DE FABRICATION LIMITÉE DE 10 ANS

LE FABRICANT RÉSERVE LE DROIT DE FAIRE DES SUBSTITUTIONS EN CAS DE RECOURS EN GARANTIE SI LES PIÈCES NE SONT PAS DISPONIBLES OR SONT OBSOLÈTES

1. Les abris extérieurs Lifetime® sont garantis à l'acheteur d'origine contre tous défauts de matériau ou de fabrication pendant une durée de dix ans à partir de la date d'achat d'origine. Le mot « défauts » signifie des défauts qui empêchent l'utilisation du produit. Les défauts résultant de mauvais usage, d'abus ou de négligence annulent cette garantie. Cette garantie ne couvre pas les dommages causés par le vandalisme, la rouille, « les calamités naturelles » ou tout autre événement en dehors du contrôle du fabricant.
2. Cette garantie n'est pas transférable et est expressément limitée à la réparation ou au remplacement du produit défectueux. Si le produit est déclaré défectueux selon les termes de cette garantie, Lifetime® Products, Inc. réparera ou remplacera les parties défectueuses gratuitement pour l'acheteur. Les frais d'expéditions aller et retour de l'usine ne sont pas couverts et sont à la charge de l'acheteur. Les frais de main-d'oeuvre et frais associés à l'enlèvement, au montage ou au remplacement de l'abri ou de ses composantes ne sont pas couverts par cette garantie.
3. Cette garantie ne couvre pas les égratignures ou éraillures du produits résultant d'une utilisation normale. Par ailleurs, les défauts résultant de dommages intentionnels, négligence, utilisation abusive ou suspension à partir de l'entretoise annulent cette garantie.
4. Toute responsabilité pour dommages incidents ou consécutifs est exclue dans la mesure permise par la loi. Bien que toutes les mesures aient été prises pour intégrer le plus haut degré de sécurité dans l'ensemble du matériel, l'impossibilité de blessure ne peut pas être garantie. L'utilisateur assume tous les risques de blessure résultant de l'utilisation de ce produit. L'ensemble de la marchandise est vendu en vertu de cette condition et aucune personne représentant la société ne peut déroger à cette politique, ni la modifier.
5. Ce produit n'est pas prévu pour l'usage institutionnel ni commercial; Lifetime® Products, Inc. n'assume aucune responsabilité pour tel usage. L'utilisation institutionnelle ou commerciale annulera cette garantie.
6. Nos articles sont offerts avec des garanties qui ne peuvent connaître d'exclusions au regard de la loi australienne sur la protection des consommateurs. Vous avez droit au remplacement ou au remboursement en cas de défaillance majeure de votre article ainsi qu'à une compensation en cas de perte ou de dommage prévisible. Vous avez aussi droit à la réparation ou au remplacement de l'article s'il n'est pas d'une qualité acceptable et que la défaillance n'est pas majeure.
7. Cette garantie remplace expressément toutes autres garanties, expresse ou tacites, y compris les garanties de commercialisation ou d'adaptation à un but particulier dans la mesure permise par les lois fédérales et des états. Ni Lifetime® Products, Inc. ni aucun de ses représentants n'assume aucune autre responsabilité concernant ce produit. Cette garantie vous accorde des droits particuliers, et vous aurai peut-être des autres droites qui varient d'un état à l'autre.

TOUS LES RECOURS EN GARANTIE DOIVENT ÊTRE ACCOMPAGNÉS DU REÇU DE VENTE.

FAIRE PARVENIR UN RAPPORT PAR ÉCRIT DE DÉFECTUOSITÉ DU PRODUIT A :

Lifetime Products, Inc., PO Box 160010 Clearfield, UT 84016-0010
ou appelez-nous au 1.800.225.3865 lundi à vendredi 0700 - 1700 (HNR)

ENREGISTREZ VOTRE ARTICLE À :

www.lifetime.com, ou appelez-nous au 1.800.225.3865 pour enregistrer votre article aujourd'hui.

POUR RECOURS EN GARANTIE INTERNATIONAUX:

Tous les recours en garantie doivent être accompagnés du reçu de vente. Faire parvenir un rapport par écrit de défectuosité du produit à votre représentant régional de ventes. Veuillez inclure votre reçu de vente daté et photographies des pièces endommagées. Pour identifier votre représentant régional, visitez www.lifetime.com/international



www.lifetime.com



GARANTÍA DE FÁBRICA LIMITADA POR 10 AÑOS

EL FABRICANTE SE RESERVA EL DERECHO DE HACER SUSTITUCIONES EN LOS ELEMENTOS REEMPLAZADOS BAJO GARANTÍA SI LAS PIEZAS NO ESTÁN DISPONIBLES O SON OBSOLETAS.

1. El comprador original recibe la garantía de que las casetas Lifetime estarán libres de defectos de material o de mano de obra por un período de 10 años a contar desde la fecha de la compra original. La palabra "defectos" se define como imperfecciones que perjudican el uso del producto. Los defectos emergentes de un mal uso, abuso o negligencia invalidarán esta garantía. Esta garantía no cubre defectos debidos a una instalación o alteración incorrecta o a un accidente. Esta garantía no cubre daños causados por vandalismo, oxidación, "actos de la naturaleza" u otros eventos que estén más allá del control del fabricante.
2. Esta garantía es intransferible, y queda expresamente limitada a la reparación o reemplazo de los productos defectuosos. Si el producto se encuentra defectuoso dentro de los términos de esta garantía, Lifetime Products, Inc. reparará o reemplazará las piezas defectuosas sin costo alguno para el comprador. Los gastos de envío hacia y desde la fábrica no están cubiertos, y quedan bajo la responsabilidad del comprador.
3. Esta garantía no cubre raspaduras ni marcas en el producto que pueden resultar de su uso normal. Además, los defectos causados por daños intencionales, negligencia, uso irrazonable o por colgarse de las cabriadas invalidarán esta garantía.
4. La responsabilidad por daños incidentales o consecuentes queda excluida hasta el punto en que lo permita la ley. Si bien se hace el mayor esfuerzo posible para lograr el más alto grado de seguridad en todos nuestros equipos, no puede garantizarse la libertad de cualquier tipo de lesión. El usuario asume todos los riesgos de lesiones emergentes del uso de este producto. Toda nuestra mercadería se vende bajo esta condición, y ningún representante de la compañía puede anular ni cambiar esta política.
5. Este producto no está pensado para el uso institucional ni comercial; Lifetime Products, Inc. no asume ninguna otra responsabilidad en conexión con este producto. El uso institucional o comercial invalidará la garantía.
6. Nuestros productos vienen con garantías que no se pueden excluir bajo la Ley del consumidor de Australia. Ustedes están autorizados para reemplazarlos u otorgar una devolución o reembolso en caso de falla mayor y en compensación por cualquier otra falla o daño previsible. También, están autorizados para hacer reparar los productos o reemplazarlos si éstos no cumplen con una calidad aceptable y si la falla no es motivo de una deficiencia mayor.
7. Esta garantía se otorga en reemplazo expreso de toda otra garantía, expresa o implícita, incluidas las garantías de comercialización o adaptación para el uso en la medida permitida por las leyes federales y estatales. Ni Lifetime Products, Inc., ni ninguno de sus representantes asume ninguna otra responsabilidad en conexión con este producto. Esta garantía le otorga derechos legales específicos, y usted puede tener otros derechos que varían de estado a estado.

NINGUNA GARANTÍA OFRECIDA POR EL FABRICANTE ES VÁLIDA EN MÉXICO

TODOS LOS RECLAMOS DE GARANTÍA DEBEN ESTAR ACOMPAÑADOS POR UN RECIBO DE COMPRA

INFORME POR ESCRITO LOS DEFECTOS EN EL PRODUCTO A:

Por favor, incluya el recibo de compra fechado y fotografías de las piezas dañadas.

Lifetime Products, Inc., PO Box 160010 Clearfield, UT 84016-0010,

o llame al 1.800.225.3865 de lunes a viernes de 0700 hasta 1700 (Hora de las Montañas)

REGISTRE SU PRODUCTO

Visite nuestra página en Internet www.lifetime.com, o llame al 1.800.225.3865 para registrar su producto hoy.

PARA RECLAMOS DE GARANTÍA INTERNACIONALES:

Todos los reclamos de garantía deben estar acompañados por un recibo de compra. Informe por escrito todos los reclamos de garantía a su representante regional de ventas. Favor de incluir su recibo de compra fechado y fotografías de las piezas dañadas.

Para identificar el representante de su región, visite www.lifetime.com/international



www.lifetime.com

ENHANCE YOUR LIFETIME® PURCHASE BY ADDING ACCESSORIES OR OTHER GREAT PRODUCTS

To purchase accessories or other Lifetime® products, visit us at:

www.lifetime.com

Or call: 1-800-424-3865

7:00 am–5:00 pm (M–F) MST and 9:00 am–1:00 pm Saturday MST

AMÉLIOREZ VOTRE ACHAT LIFETIME® EN AJOUTANT DES ACCESSOIRES OU DES AUTRES PRODUITS

Pour acheter des accessoires ou des autres produits Lifetime®, rendez-vous une visite à :

www.lifetime.com

Ou appelez-nous au 1-800-424-3865

Du lundi au vendredi 7 h – 17 h (HNR) et samedi 9 h – 13 h (HNR)

MEJORE SU COMPRA LIFETIME® Y AÑADA ACCESORIOS U OTROS PRODUCTOS EXCELENTES

Para comprar accesorios u otros productos Lifetime® EUA, visítenos en:

www.lifetime.com

O llame al: 1.800.424.3865

De lunes hasta viernes 7:00 h–17:00 h (HNR) y sábado 9:00 h–13:00 h (HNR)



www.lifetime.com

