

*Windsor 44*  
*Art. Nr. 4415240*  
1/10

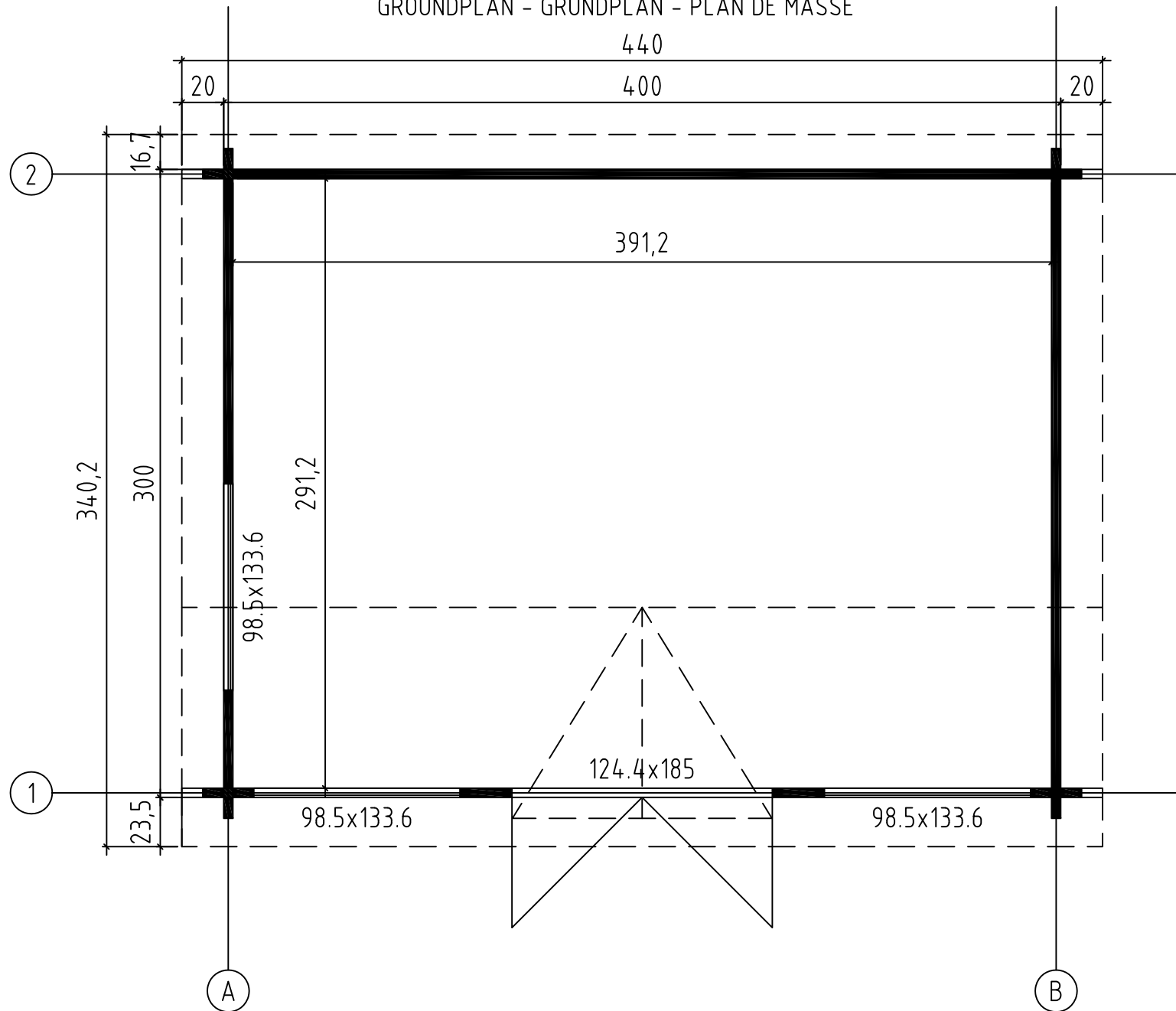

Art.Nr. 4415240

GROUNDPLAN - GRUNDPLAN - PLAN DE MASSE



Art.Nr. 4415240  
FOUNDATION - FUNDAMENT - FONDATION

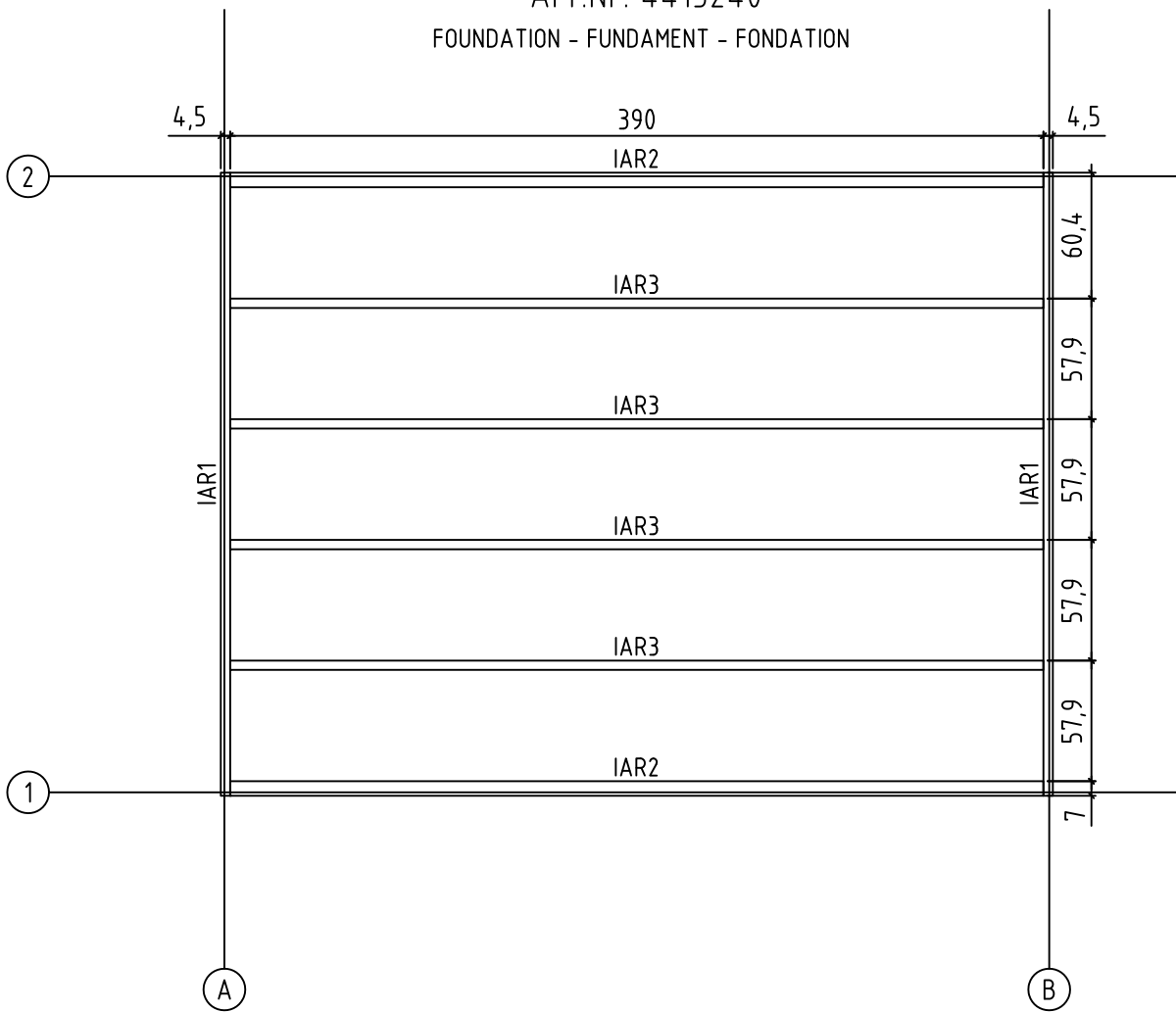

FLOOR BOARDS - FUSSBODENBRETTER - LAME DE PLANCHER

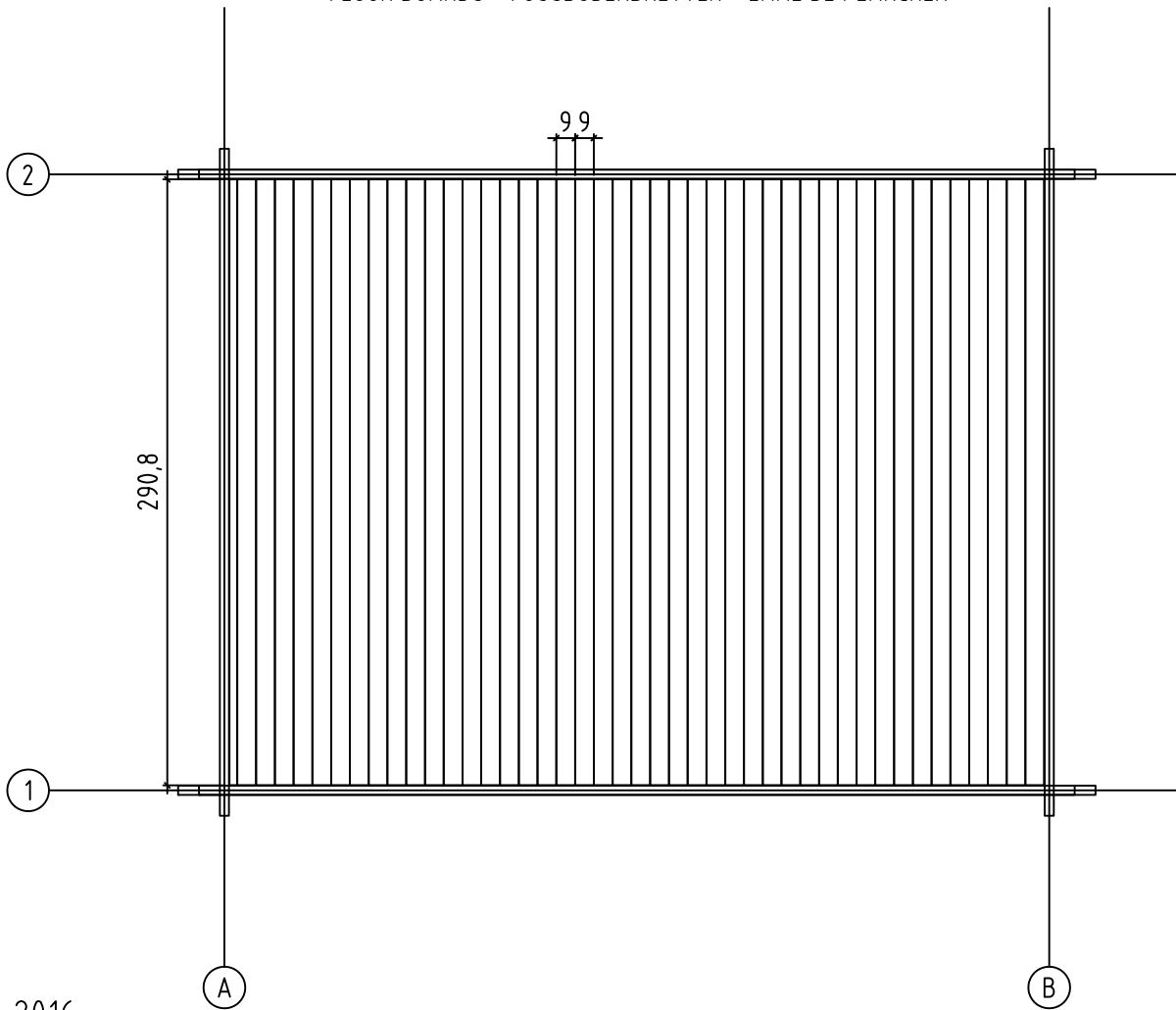

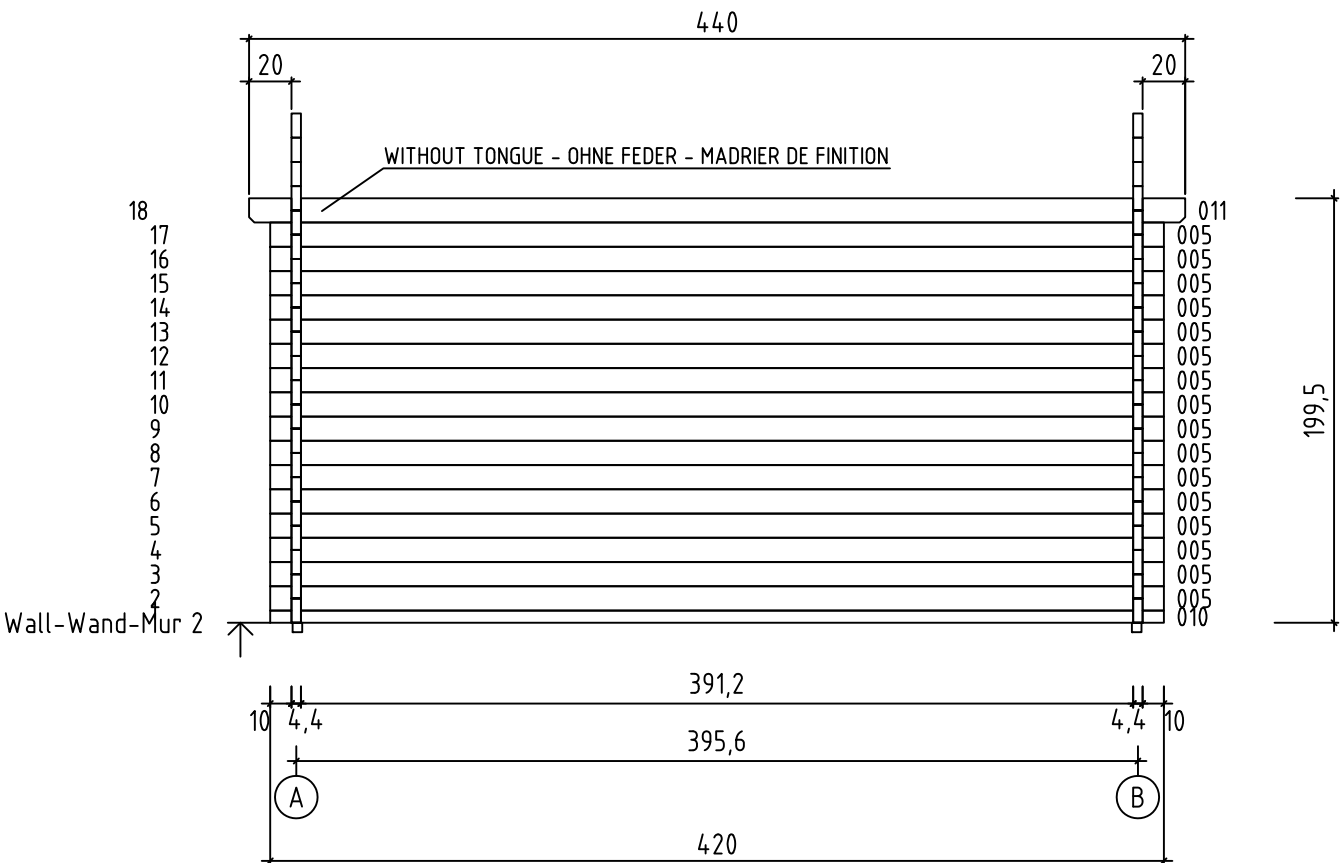
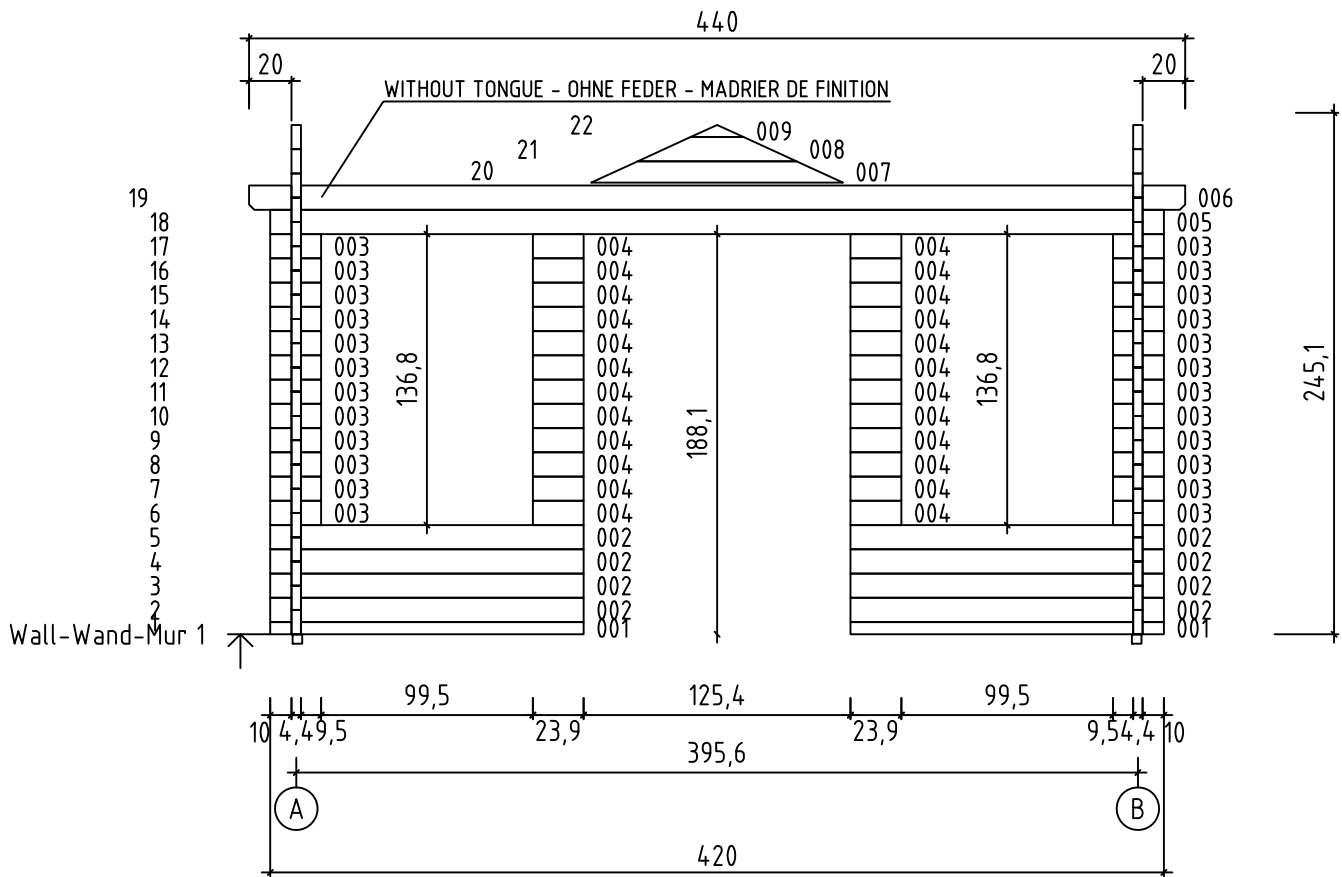

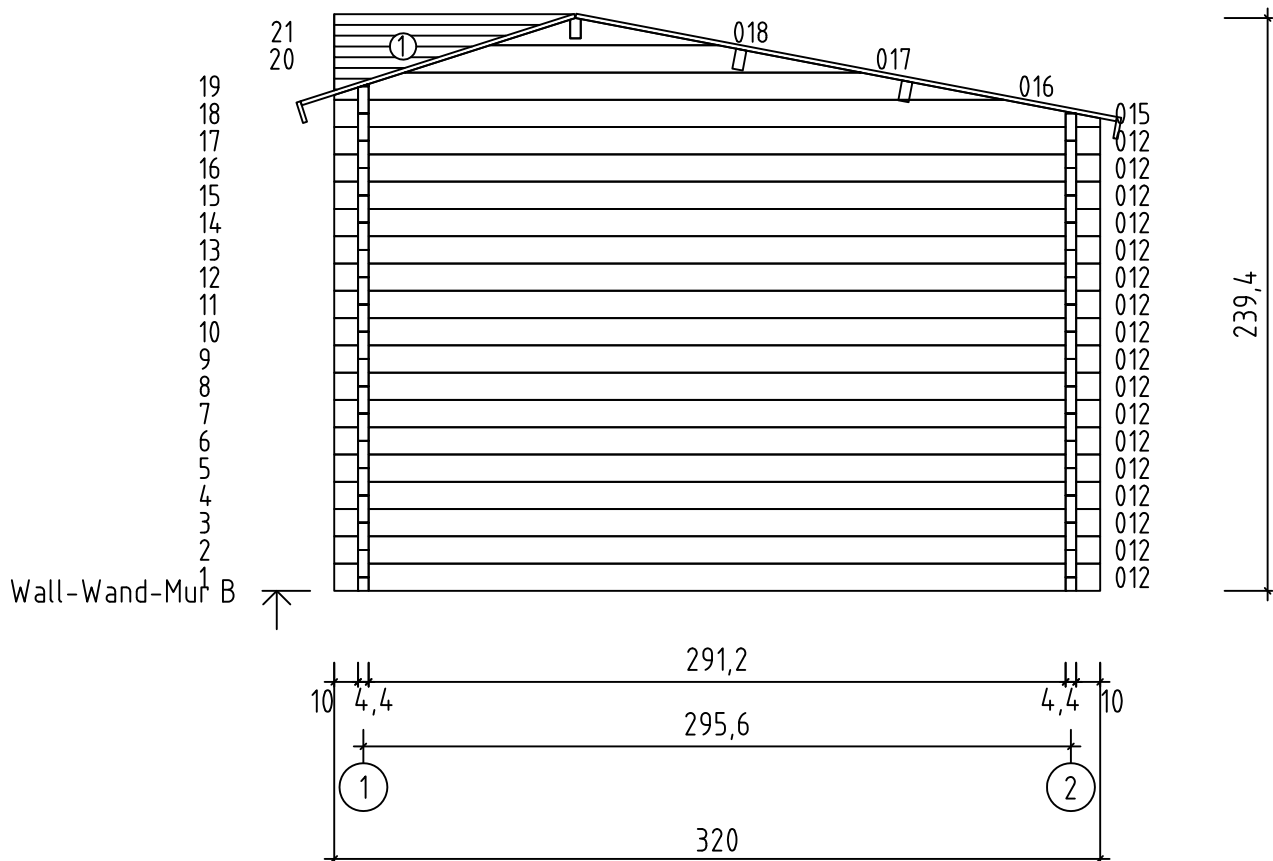
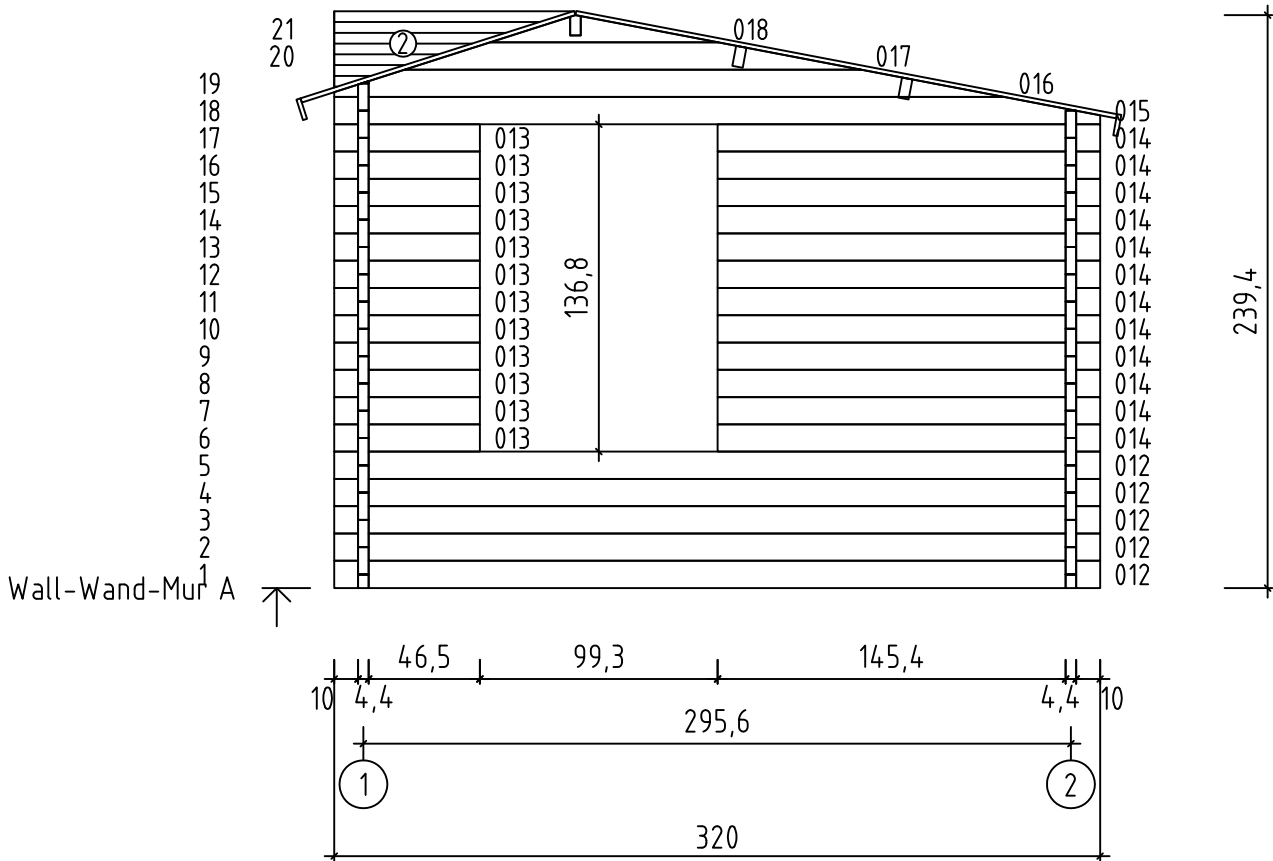

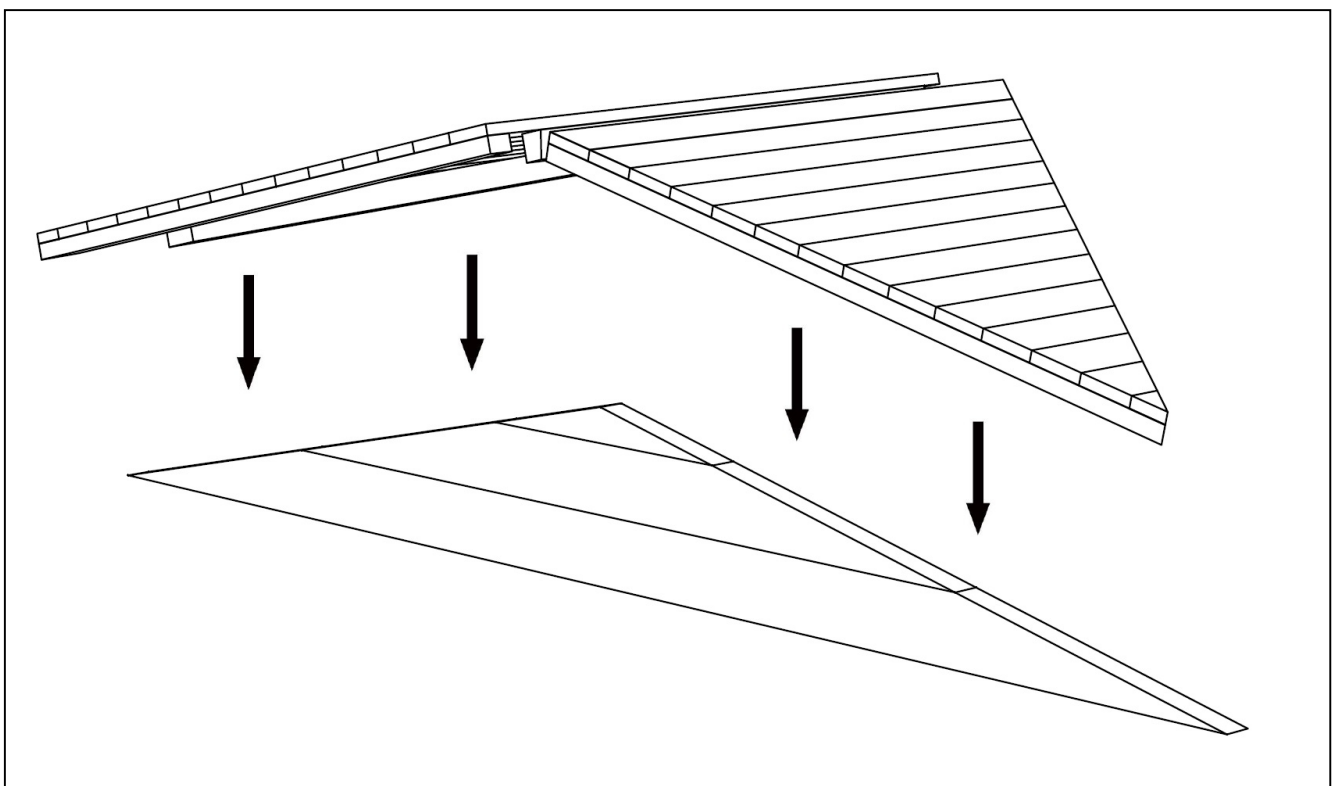
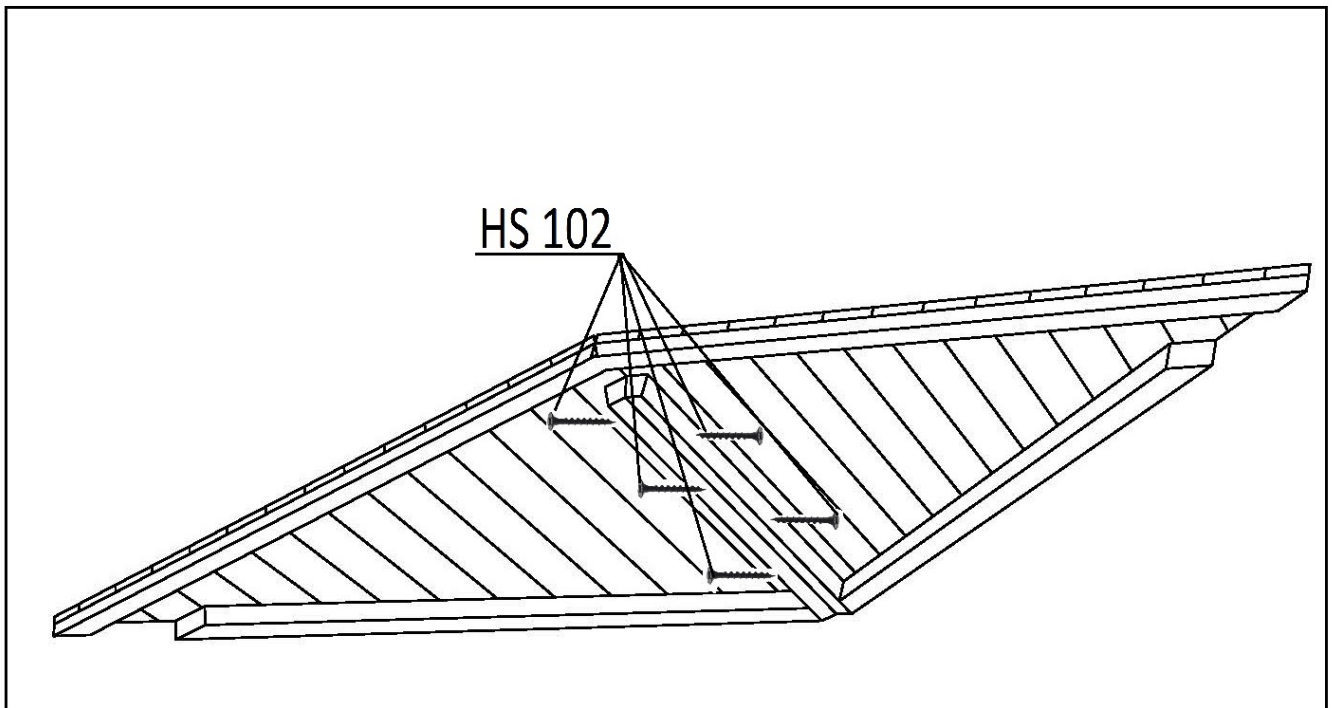

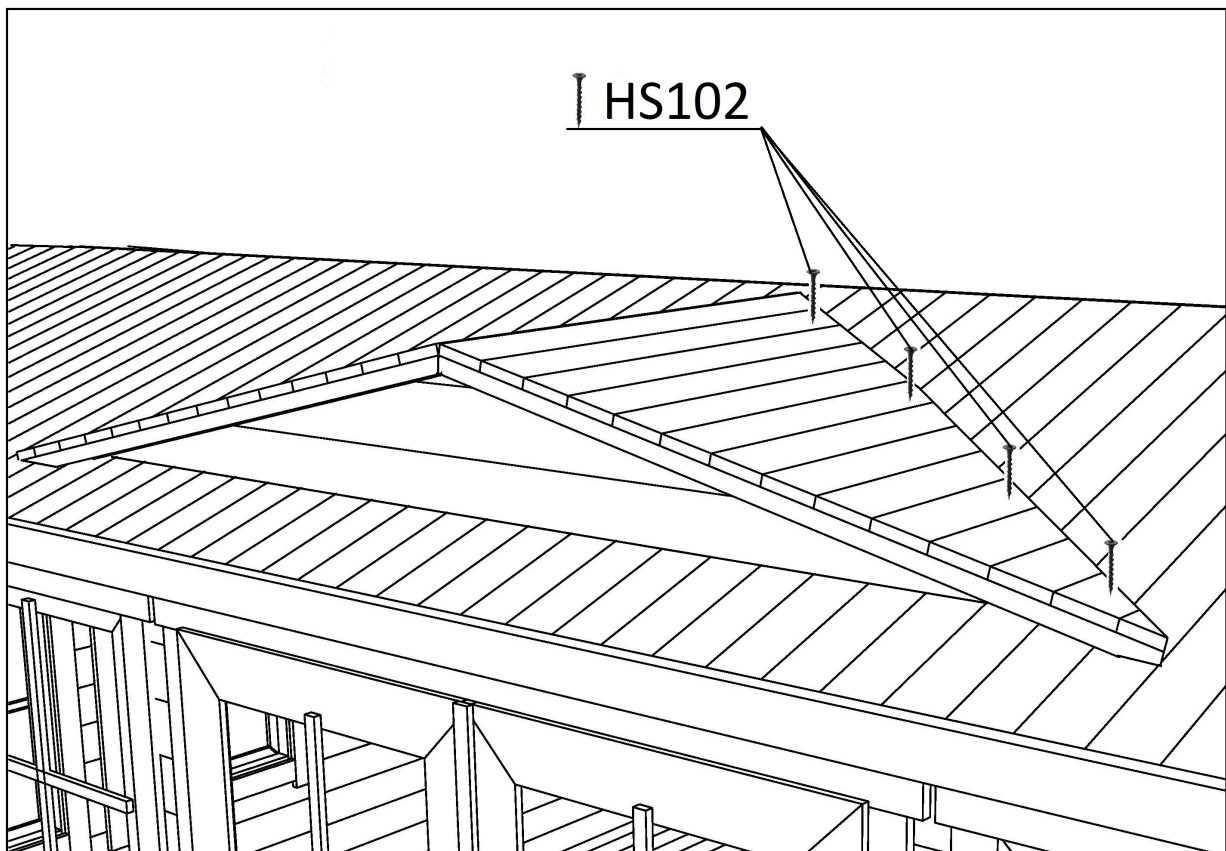
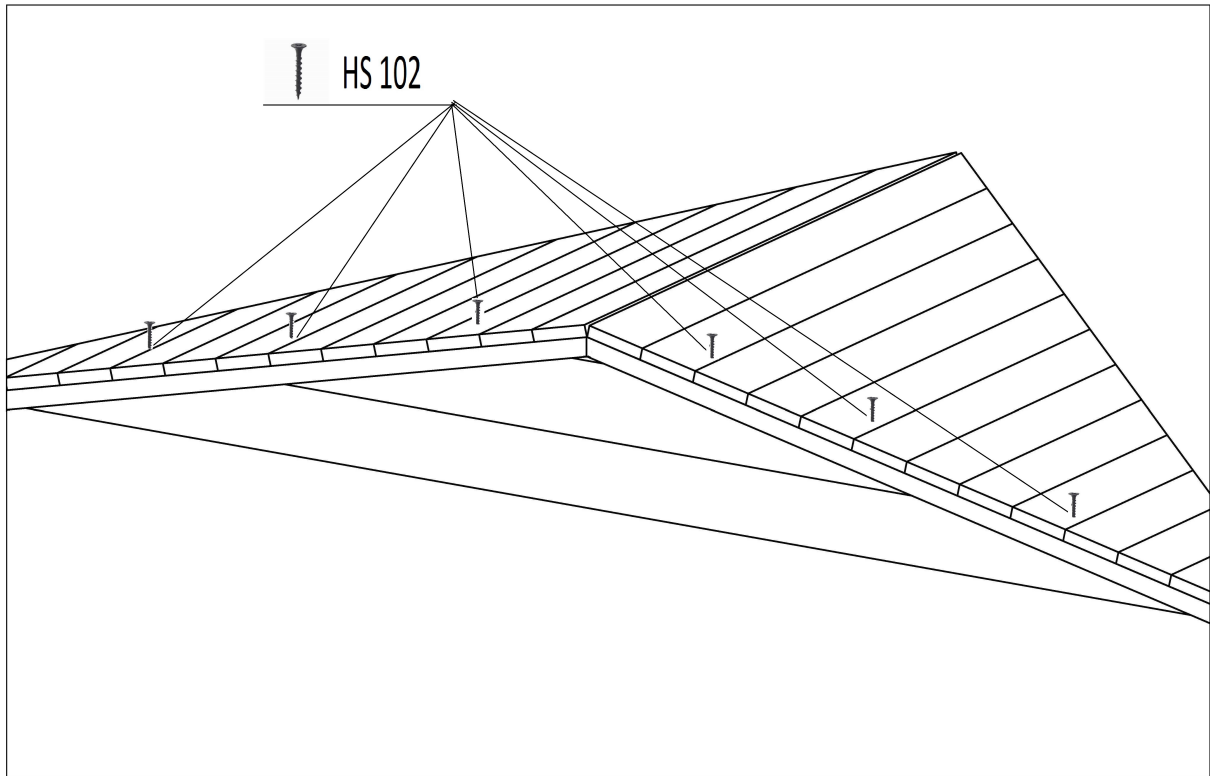

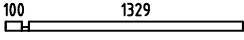
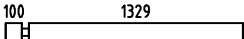

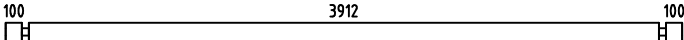
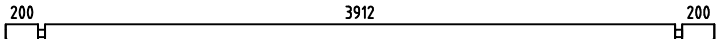
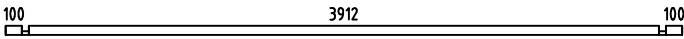
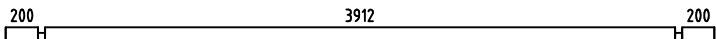
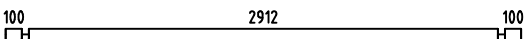
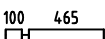
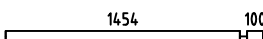

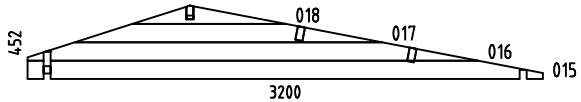
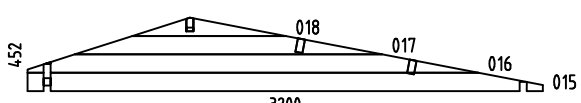



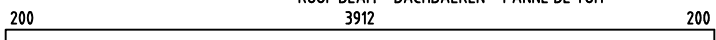
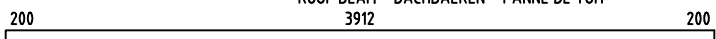











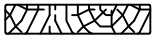

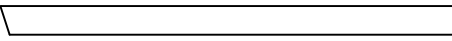
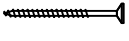
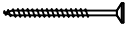



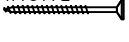
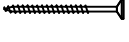

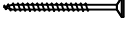



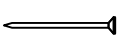

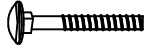

Pos	14.04.2016	Piece list - Stückliste - Liste des pièces Art.Nr. 4415240	8/10	Q.	P (mm)	L (mm)
001				2	44x57	1473
002				8	44x114	1473
003				24	44x114	239
004				24	44x114	239
005				17	44x114	4200
006				1	44x120	4400
010				1	44x57	4200
011				1	44x120	4400
012				22	44x114	3200
013				12	44x114	609
014				12	44x114	1598
W1-1				1		
WA-1				1		
WB-1				1		
IAR2	FOUNDATION - FUNDAMENT - FONDATION 			2	70x45	3900
IAR3	FOUNDATION - FUNDAMENT - FONDATION 			4	45x45	3900
IAR1	FOUNDATION - FUNDAMENT - FONDATION 			2	45x45	2990
PR11	ROOF BEAM - DACHBALKEN - PANNE DE TOIT 			1	44x140	4400
A.PR21	ROOF BEAM - DACHBALKEN - PANNE DE TOIT 			2	44x140	4400
	FLOOR BOARDS - FUSSBODENBRETTER - LAME DE PLANCHER 			44	90x18	2908
DB	ROOF BOARDS - DACHBRETTER - VOLIGES 			49	90x18	2300
DB	ROOF BOARDS - DACHBRETTER - VOLIGES 			49	90x18	1200
FL	FLOOR FILLET-FUSSBODENLEISTE - CORNIERE DE FINITION DU PLANCHER 				18x18	13.63

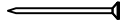

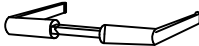
Pos	14.04.2016	Piece list - Stückliste - Liste des pièces Art.Nr. 4415240	9/10	Q.	P (mm)	L (mm)
DPL		ROOFING FELT FILLET - DACHPAPPENLEISTE - BAGUETTE DE FIXATION DU FEUTRE BITUMEUX		2	18x58	740
DPL		ROOFING FELT FILLET - DACHPAPPENLEISTE - BAGUETTE DE FIXATION DU FEUTRE BITUMEUX		2	18x58	1250
DPL		ROOFING FELT FILLET - DACHPAPPENLEISTE - BAGUETTE DE FIXATION DU FEUTRE BITUMEUX		2	18x58	2350
TB		EAVES BOARD - TRAUFBRETT - BANDEAU DE TOIT		2	18x90	4400
DRV		ROOF EDGE REINFORCEMENT - DACHRANDVERSTÄRKUNG - CORNIERE DE RENFORT DE BORD DE TOIT		2	28x34	4400
KFS		STORM PROTECTION - STURMLEISTE - LATTE ANTI-TEMPETE		4	22x45	2050
GL		GABLE MOULDING - GIEBELLEISTE - PLANCHE DE RIVE		2	18x120	1250
GL		GABLE MOULDING - GIEBELLEISTE - PLANCHE DE RIVE		2	18x120	2350
GL		GABLE MOULDING - GIEBELLEISTE - PLANCHE DE RIVE		2	18x90	740
HS88		SCREW FOR GEORGIAN BARS - SCHRAUBE FÜR SPROSSEN - VIS DE BARRES GEORGIENNE		54	2.5x20	
HS89		SCREW FOR GEORGIAN BARS - SCHRAUBE FÜR SPROSSEN - VIS DE BARRES GEORGIENNE		18	2.5x20	
HS12		SCREW FOR GABLE SEGMENT - SCHRAUBEN FÜR DECKBLATT - VIS POUR FIXATION LOSANGE DE FINITION		6	3.5x35	
HS16		SCREW FOR GABLE MOULDING - SCHRAUBEN FÜR GIEBELLEISTE - VIS DE FIXATION POUR PLANCHE DE RIVE		24	3.5x50	
HS3		SCREW FOR DOOR FILLET - SCHRAUBE ZUR BEFESTIGUNG TÜRLEISTE - VIS D'ASSEMBLAGE DU CADRE DE PORTE		5	3x30	
HS32		SCREW FOR EAVES BOARDS - SCHRAUBEN FÜR TRAUFBRETT - VIS DE FIXATION POUR BANDEAU DE TOIT		20	4x40	
HS26		SCREW FOR ROOF EDGE REINFORCEMENT - SCHRAUBEN FÜR DACHRANDVERSTÄRKUNG - VIS POUR RENFORT DE BORD DE TOIT		20	4x40	
HS102		SCREW FOR ROOF SHIELDS - SCHRAUBE FÜR ELEMENT - VIS POUR PANNEAU DE TOITURE		19	4x60	
HS43		SCREW FOR ROOF BEAMS - SCHRAUBEN FÜR DACHBALKEN - VIS POUR PANNE DE TOIT		10	5x120	
		SCREW FOR 1. WALL BEAM - SCHRAUBE FÜR 1. BOHLENREIHE - VIS DE FIXATION DES FONDATIONS		6	5x90	
HS39		SCREW FOR FUNDAMENT - SCHRAUBEN ZUR BEFISTIGUNG FUNDAMENT - VIS POUR FONDATION		12	5x90	
HS41		SCREW FOR DOOR JAMB - SCHRAUBE FÜR TÜRRAHMEN - VIS DE FIXATION POUR MONTANT DE PORTE		4	5x90	
FS3		WINDOW HANDLE FITTINGS-FENSTERGRIFF - POIGNÉE D'OUVERTURE DE FENETRE		3		
NFF		ZN NAIL FOR FLOOR FILLET - ZN NÄGEL FÜR FUSSBODENLEISTE - POINTE POUR CORNIERE DE FINITION DU PLANCHER		28	1.4x40	
SH44		HAMMER BLOCK - SCHLAGHOLZ - CALLE DE FRAPPE		1		
NFD		ZN NAIL FOR ROOFING FELT FILLET - ZN NÄGEL FÜR DACHPAPPENLEISTE - POINTE POUR BAGUETTE FIXATION FEUTRE BITUMEUX		26	2x40	

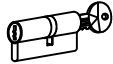
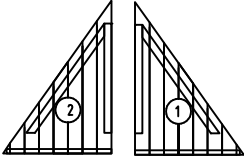
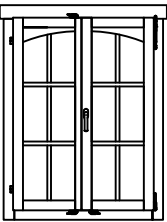
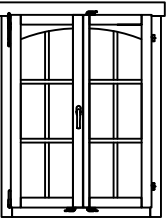
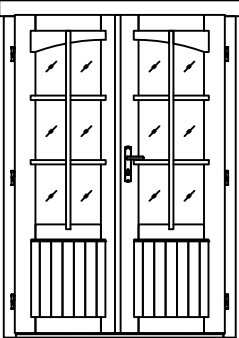
Pos	14.04.2016	Piece list - Stückliste - Liste des pièces Art.Nr. 4415240	10/10	Q.	P (mm)	L (mm)
GS		GABLE SEGMENT-DECKBLATT - LOSANGE DE FINITION		3		
SFS		NUT FOR STORM PROTECTION - SCHRAUBENMUTTER FÜR STURMLEISTE - ÉCROU POUR LAME ANTI-TEMPETE		8		
BFS		BOLT FOR STORM PROTECTION - BOLZEN FÜR STURMLEISTE - VIS POUR LAME ANTI-TEMPETE		8		
DFS		WASHER FOR STORM PROTECTION - DICHTSCHEIBE FÜR STURMLEISTE - RONDELLE POUR LAME ANTI-TEMPETE		8		
NH1		ZN NAIL FOR FLOOR - ZN NÄGEL FÜR FUSSBODENBRETTER - CLOUS POUR PLANCHER		270	2x50	
NF2		ZN NAIL FOR ROOF - ZN NÄGEL FÜR DACHBRETTER - POINTE POUR TOIT		254	2x50	
TS3		DOOR HANDLE FITTINGS-TÜRGRIF - SET DE GARNITURES DE SERRURE DE PORTE		1		
TS4		SET OF DOOR LOCK COVERS - SCHLOSSBLENDEN - SET DE GARNITURES DE SERRURE DE PORTE		1		
TS2		MALE BOLT HINGE FOR DOOR - TÜRRIEGEL - PARTIE MALE DE CHARNIERE DE PORTE		6		
TS6		CYLINDER LOCK -ZYLINDERSCHLOSS - CYLINDRE DE SERRURE		1	30x35	
		ROOF SHIELD - ELEMENT - PANNEAU DE TOITURE		2		
		WINDOW - FENSTER - FENETRE 985x1336 TAK.1.106.PSP.Kf DGP+A+		2		
		WINDOW - FENSTER - FENETRE 985x1336 TAK.1.106.PSV.Kf DGP+A+		1		
		DOOR - TÜR - PORTE 1244x1850 TUK.2.066.PVP.MMKWe DGP+A+		1		