

Schiltern

4000x3000

35 mm

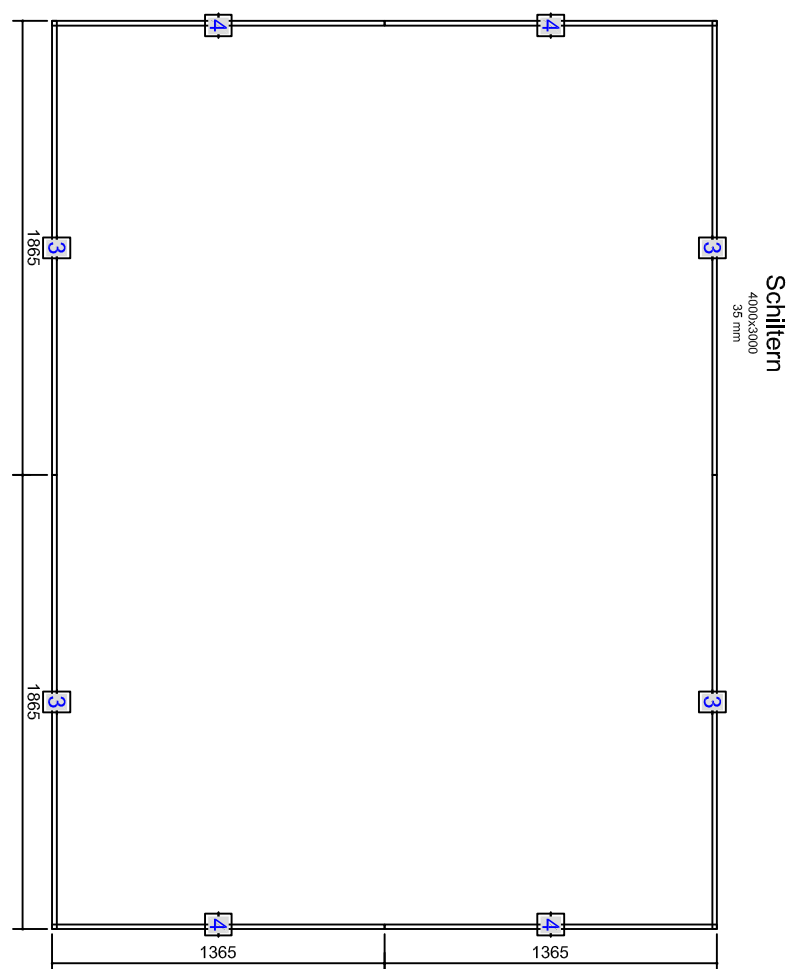

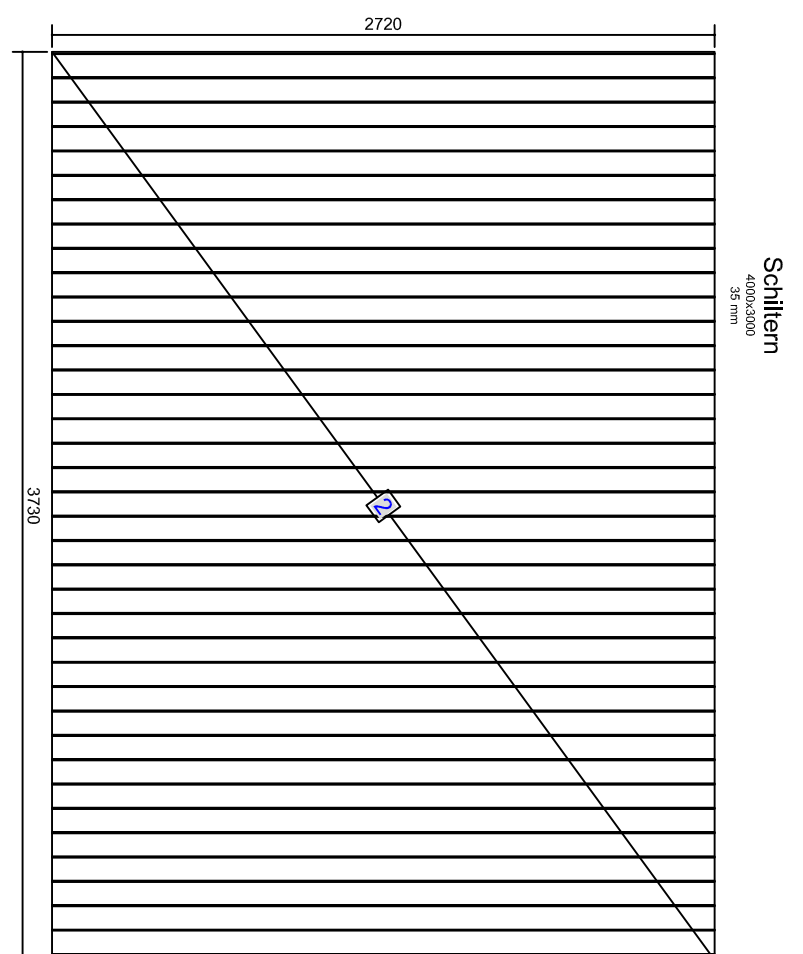
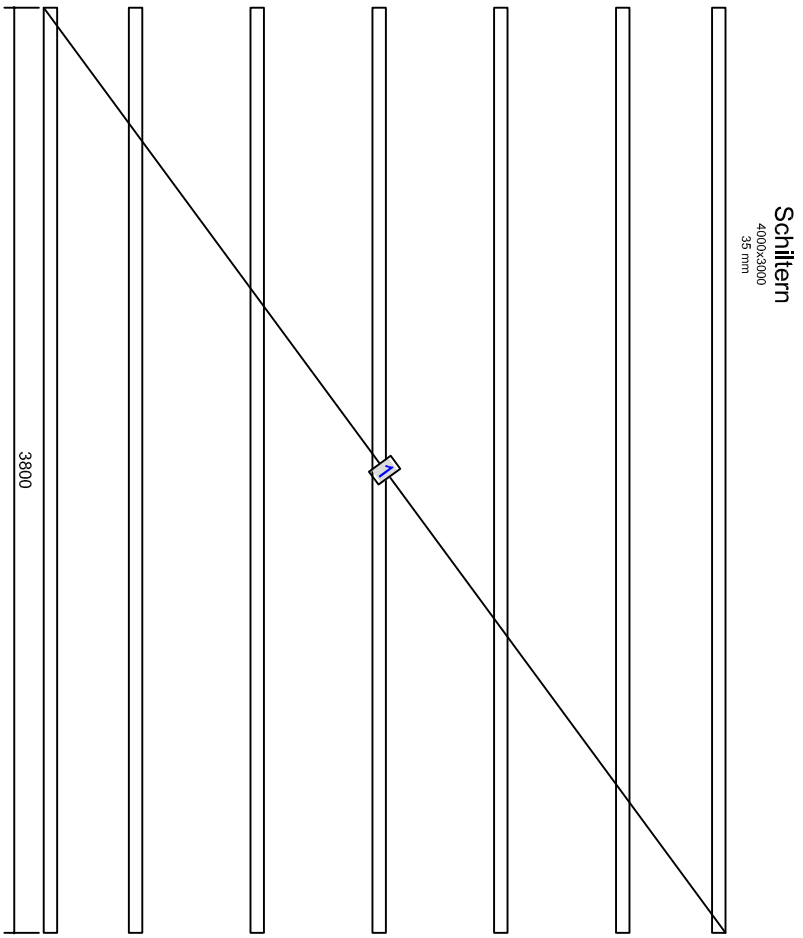
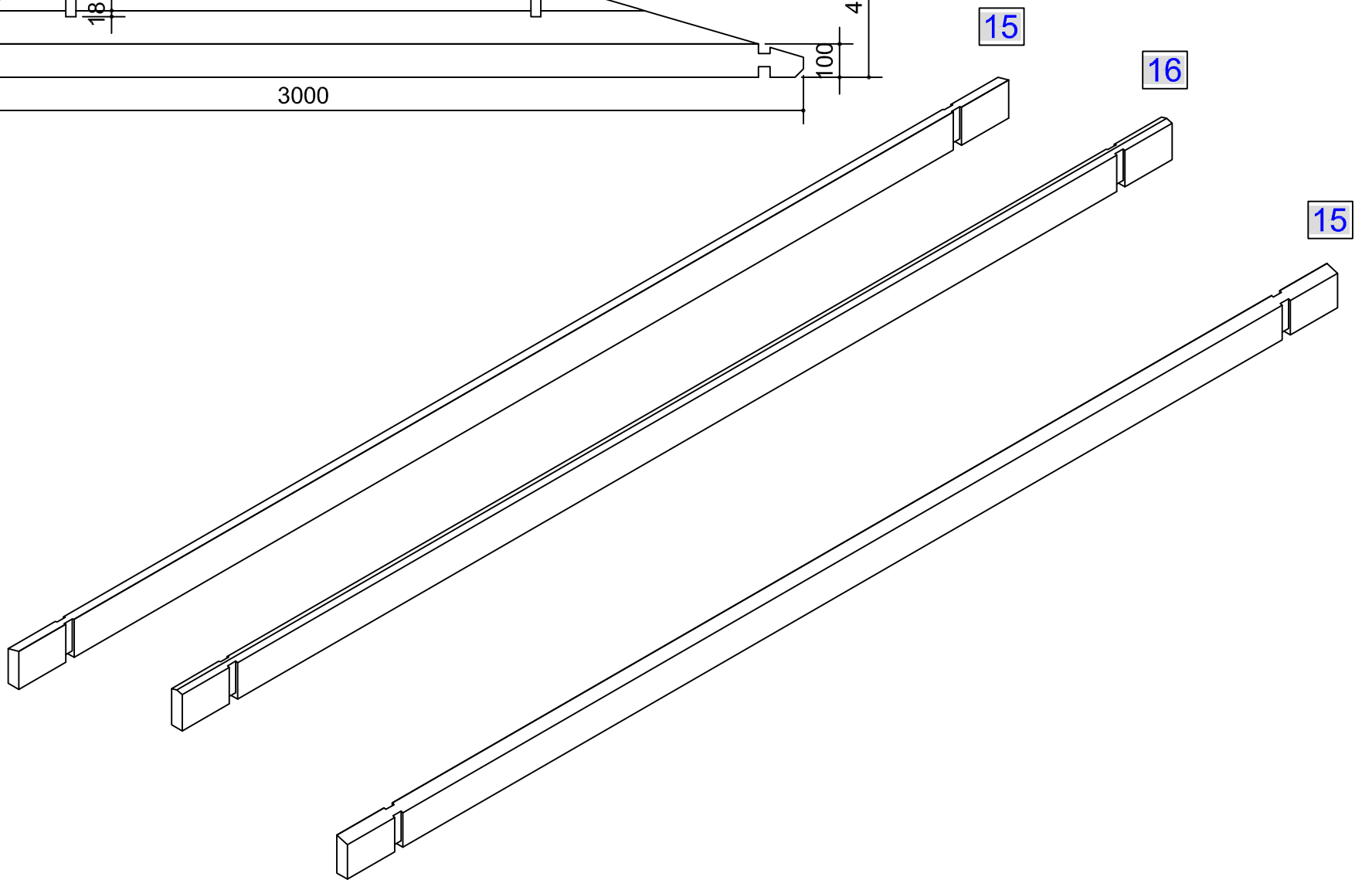
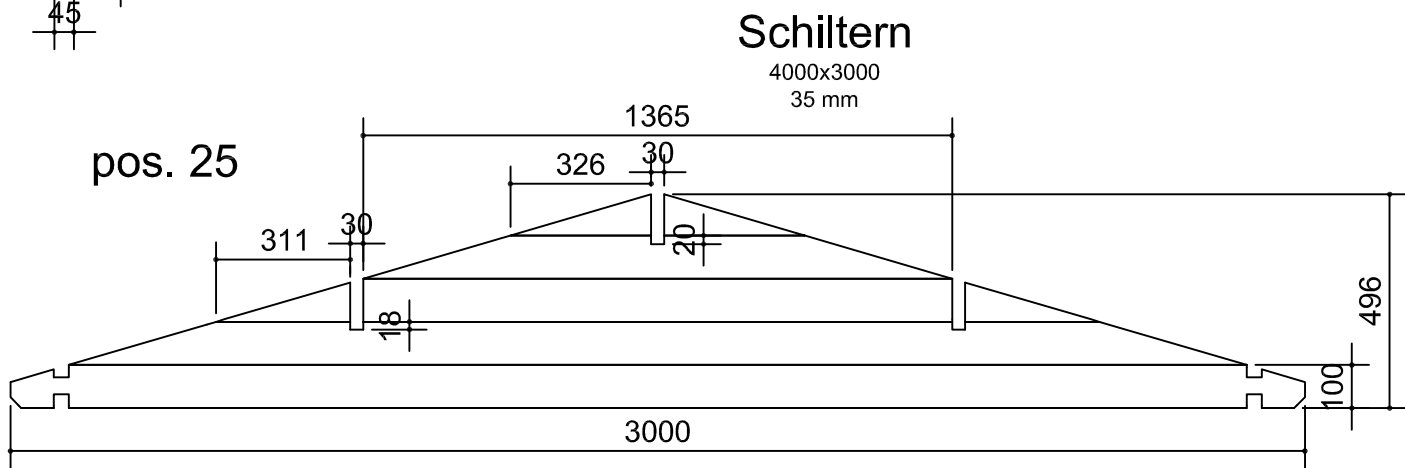
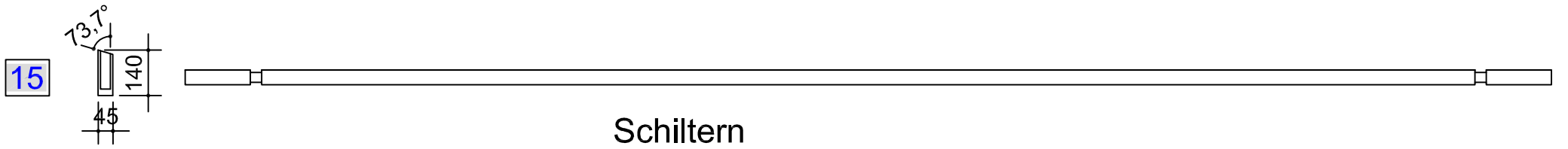
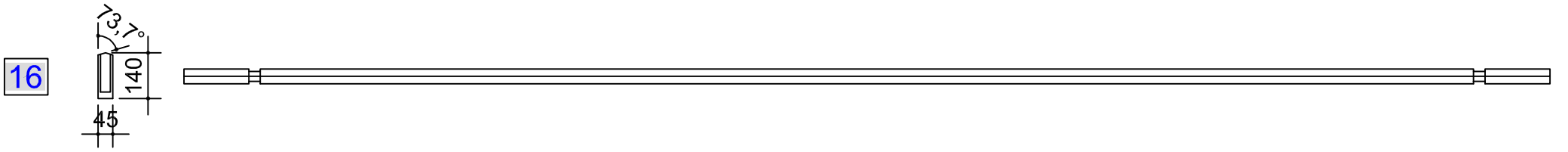
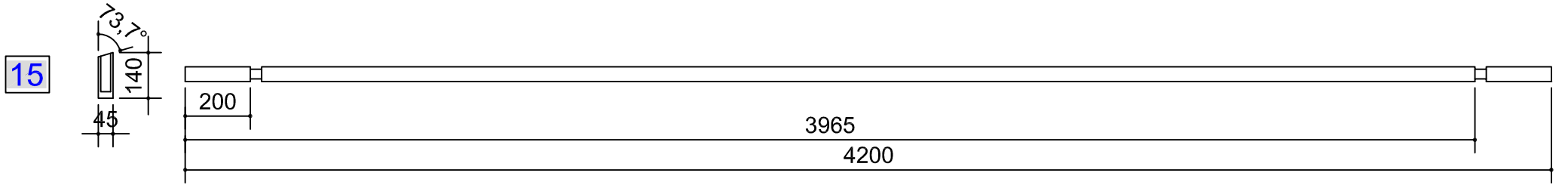

Schiltern

4000x3000
35 mm

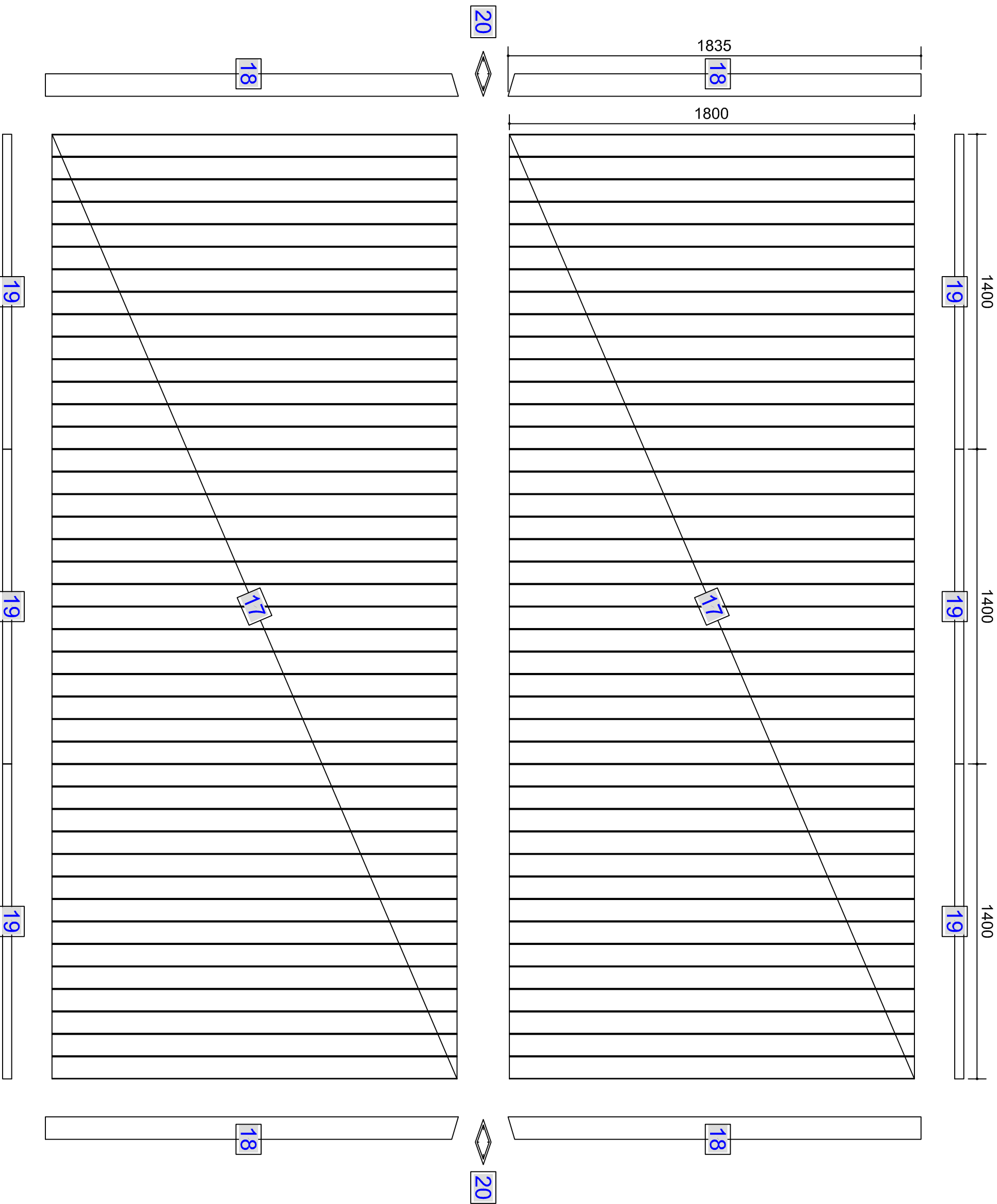

Schiltern
4000x3000
35 mm

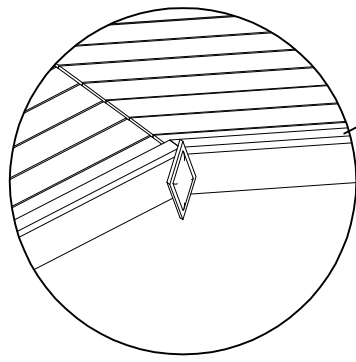

pos. 29

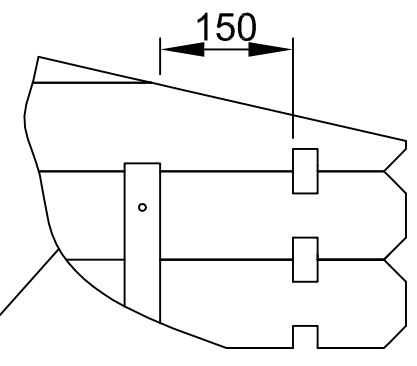
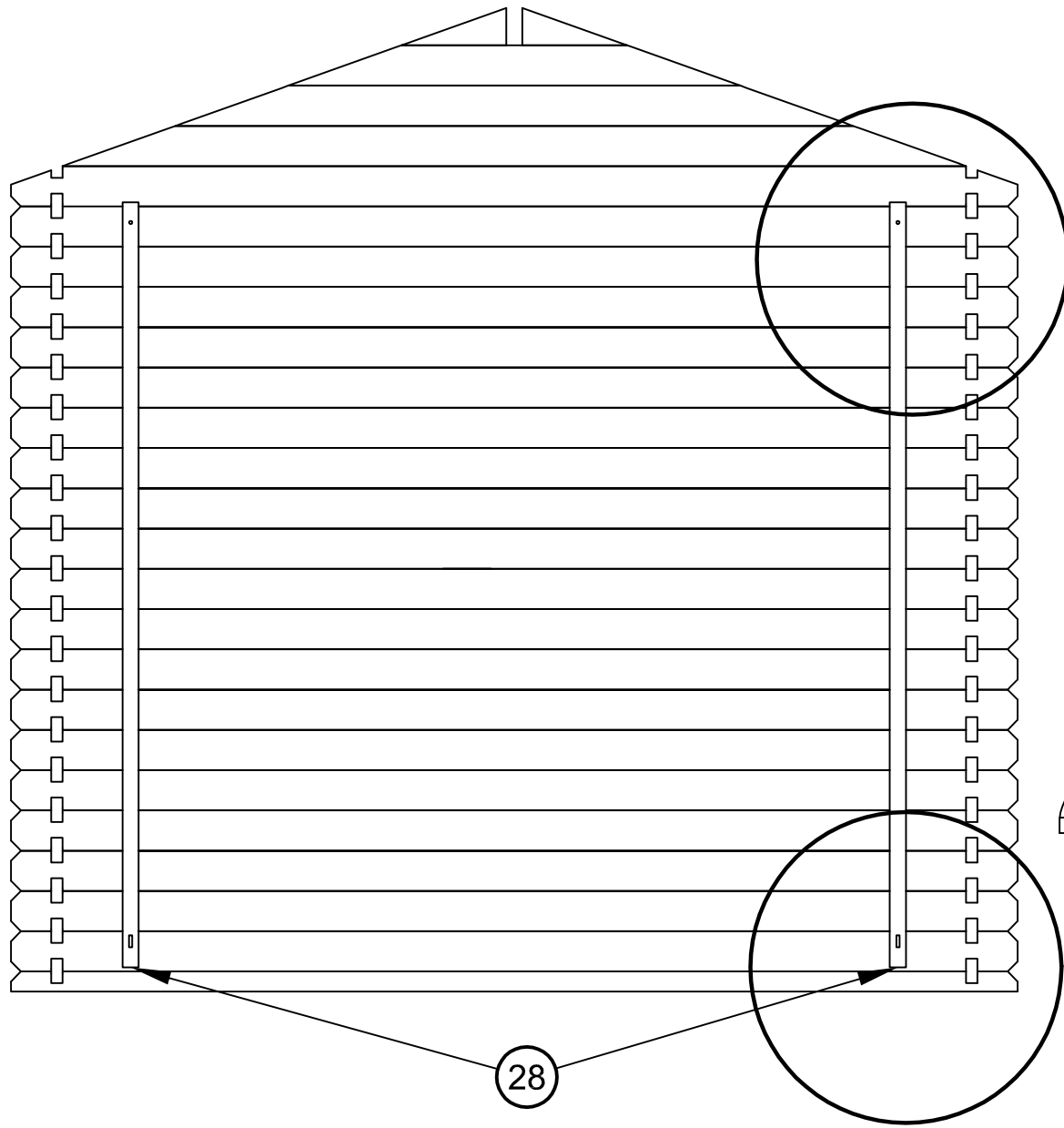
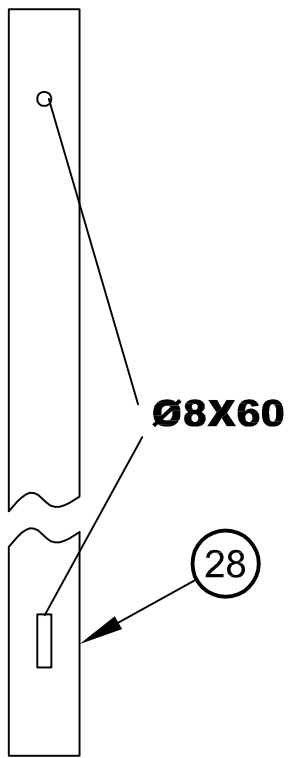

150

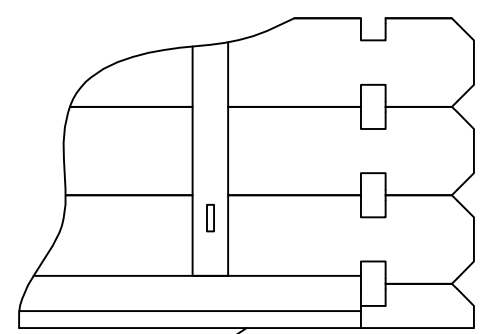

Schiltern
4000x3000
35 mm

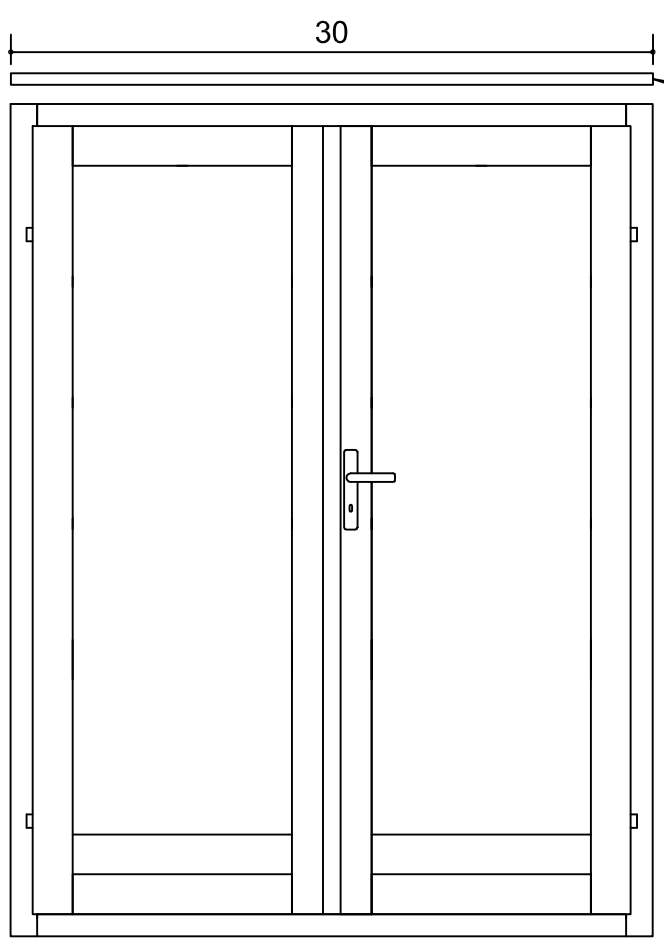

30

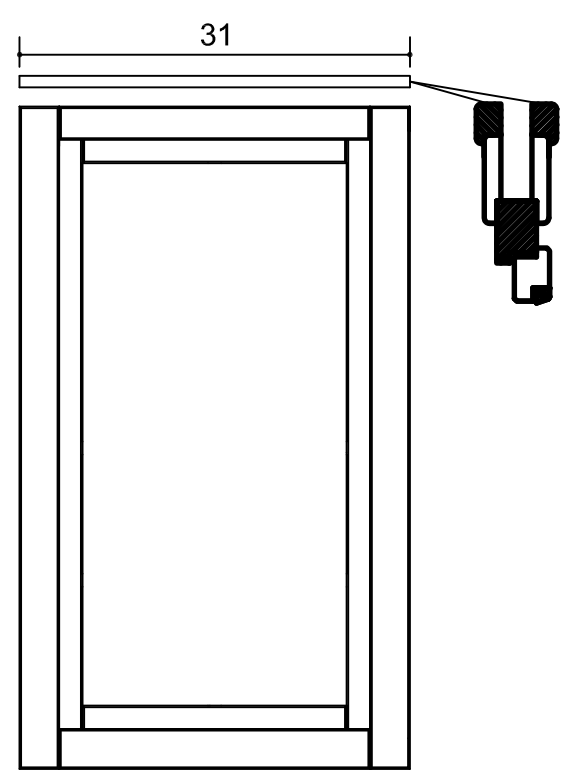

31

Door and window extra part above is longer
must be cut in the construction site

Schiltern

400x300 cm
35mm 2013.02.15





BE 2013

-Date-

-Packing Nr.-

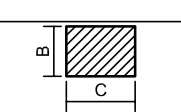
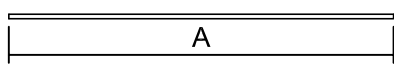
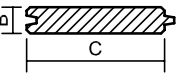
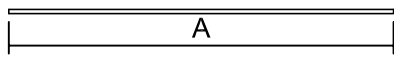
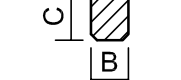
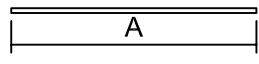
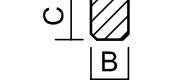
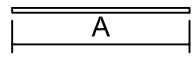
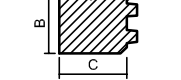
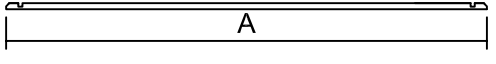
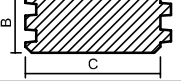
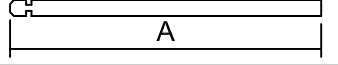
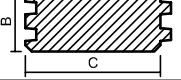
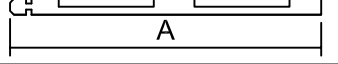
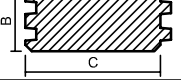
-Name, last name-

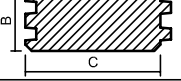
-Signature-

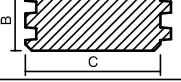
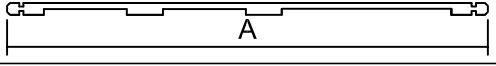
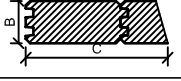
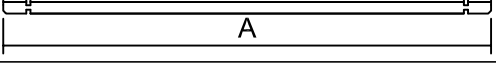
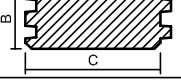
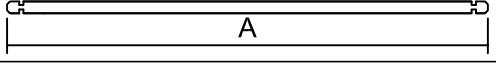
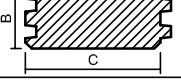
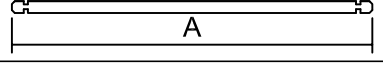
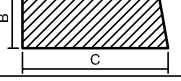
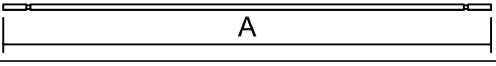
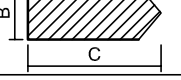
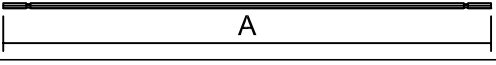
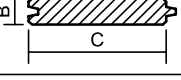
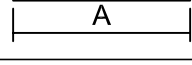
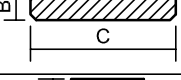
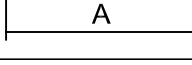
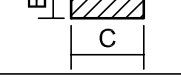
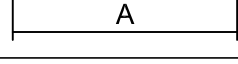
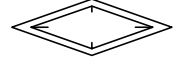
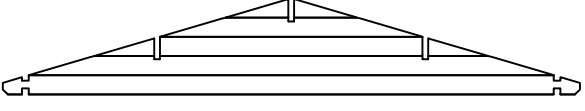
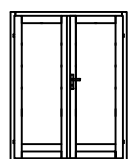
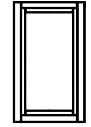
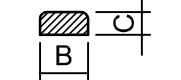
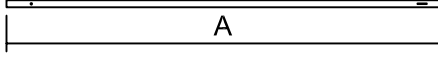
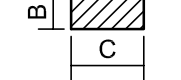
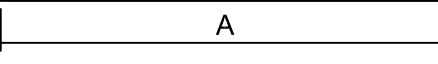
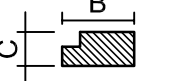
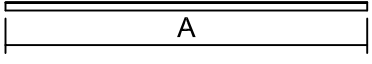
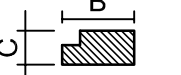
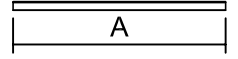
Degree < 74°	Dimensions, mm			Pos.	Quantity	
	A	B	C			
		3800	40	60/55	1	7
		2720	19	100/86	2	38/44
		1865	19	24	3	4
		1365	19	24	4	4
		4000	35	50	5	2
		2285	35	100	6	3
		2285	35	100	7	1
		305	35	100	8	32
		300	35	100	9	28
		4000	35	100	10	1
		4200	35	150	11	2
		4000	35	100	12	19
		3000	35	100	13	40
		4200	45	140	15	2
		4200	45	140	16	1
		1800	19	100/86	17	84/98
		1835	19	90	18	4
		1400	19	40	19	6
		200	70		20	2
		3000	496		25	2
		1410	1850		26	1
		690	1500		27	2
		~1880	40	19	28	4
		1835	19	40	29	4
		1510	45	28	30	2
		790	45	28	31	4