

FLOWER CIRCLE PERGOLA

FSFCIRC 228cm [H] x 240cm [W] x 27cm [D]
221901A001MMBZ01C1

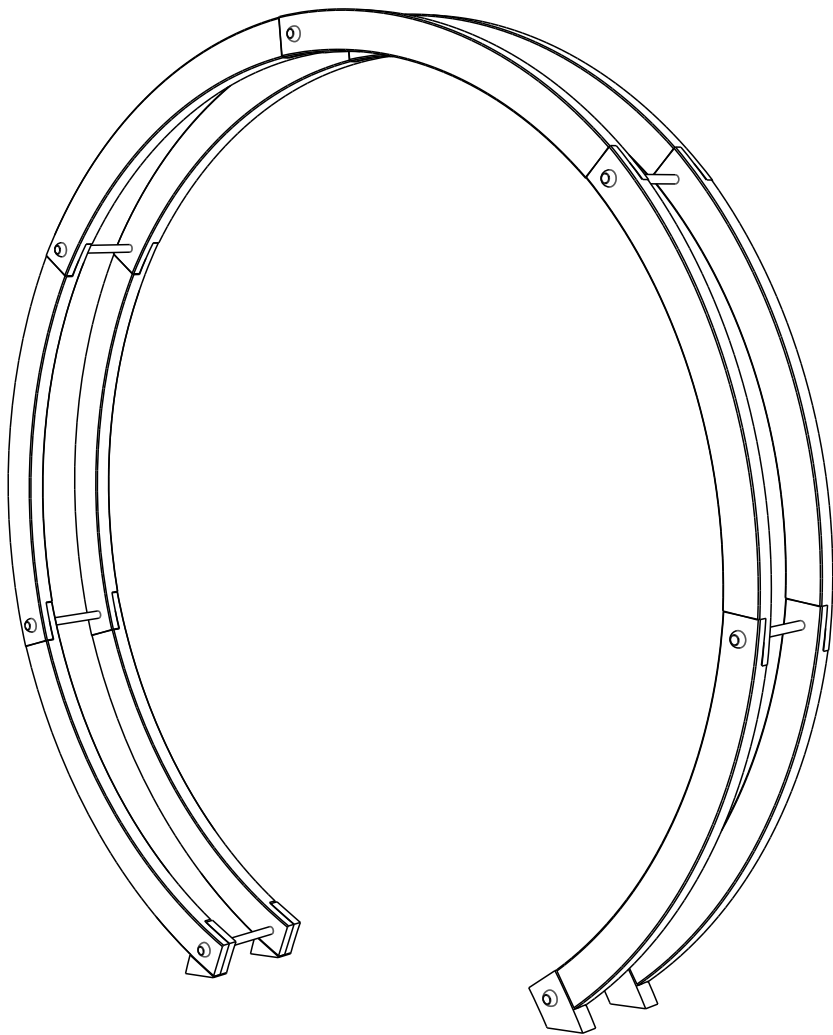

BEFORE YOU START

Check the pack/s and make sure that you have all of the parts listed below.

If not, contact your retailer who will be able to help you.

When you are ready to start make sure you have the right tools to hand, plenty of space with a clean and dry area for assembly.

It is advisable for two people to carry out the work.

Where the wood is screwed we advise to pre-drill the holes (the diameter of the holes should be 2mm smaller than the diameter of the used screw)

Recommended tools (not included)

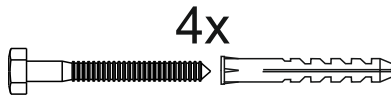
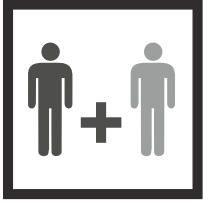

4x

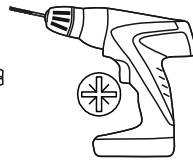

drill or screwdriver

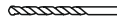
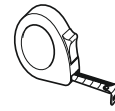

A

Curved beam x12

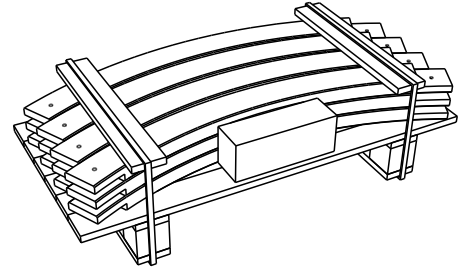
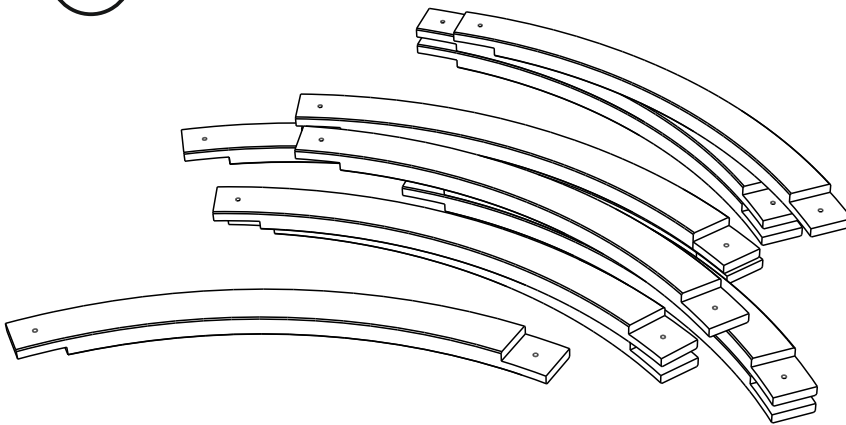

B

Foot x4

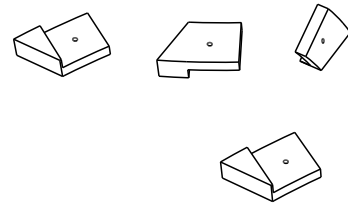

Hardware pack

[a] Washer x28

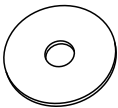

[b] Plastic cup x14

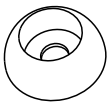

[c] Cap x14



[d] M10 x 70 hex bolt x14

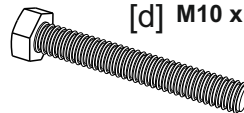

[e] Screw 4 cm x28

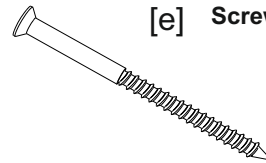

[f] Metal brackets x4

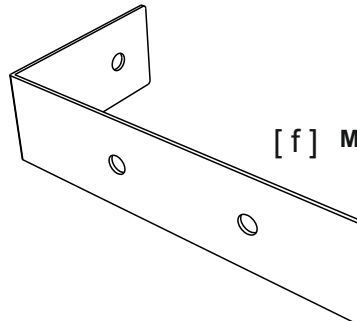

[g] Metal rods x7

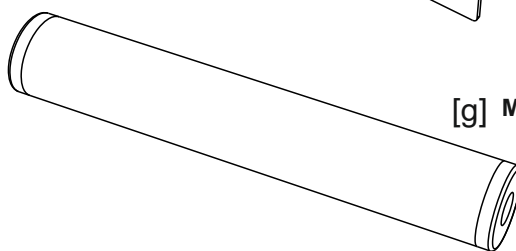

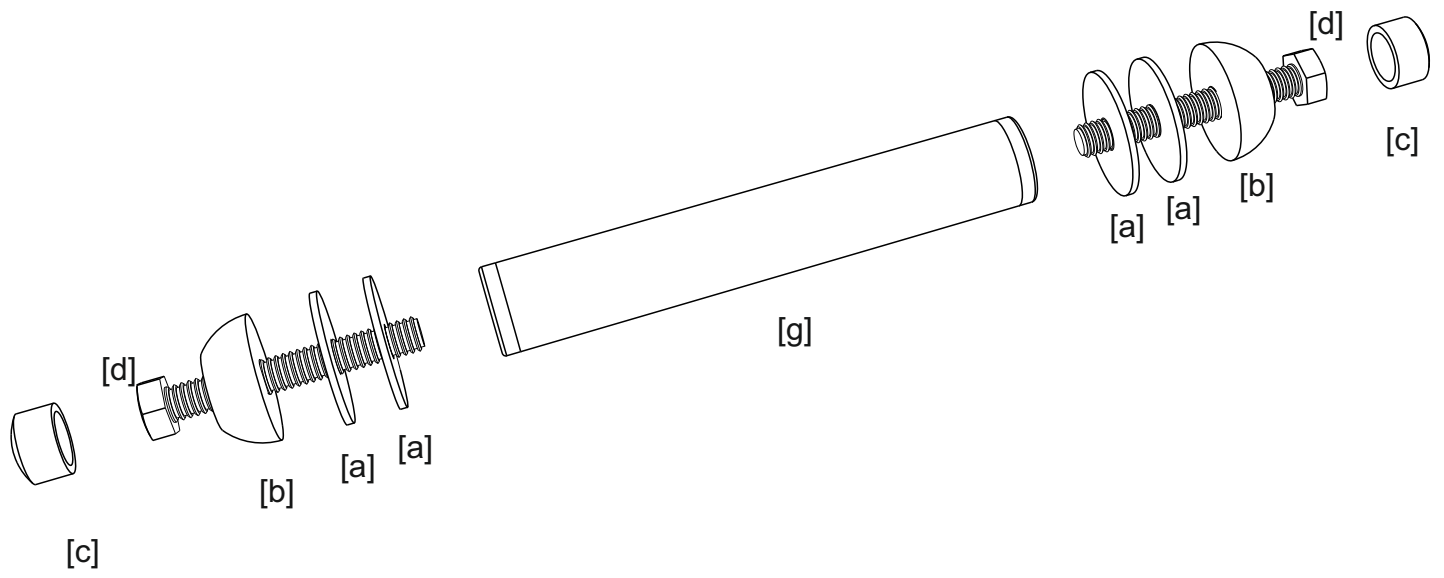

PLAN

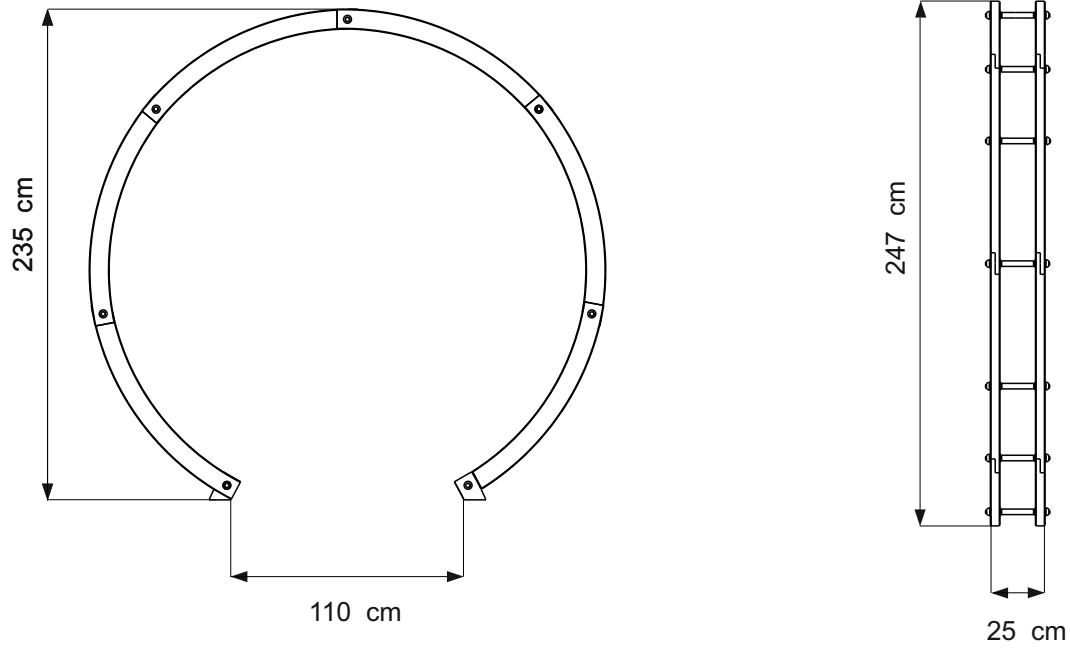

FOOTPRINT

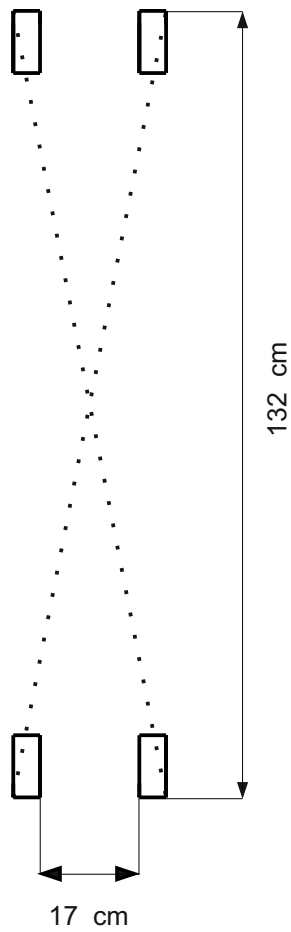

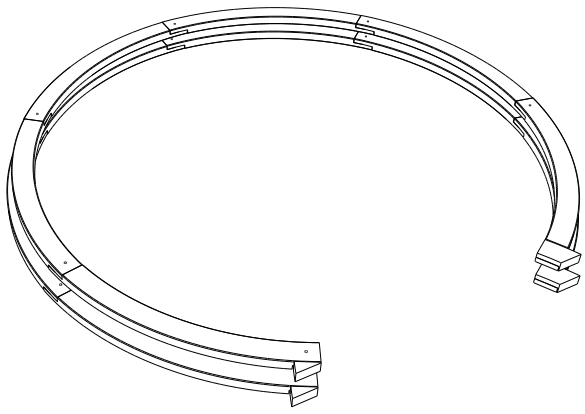

[e]

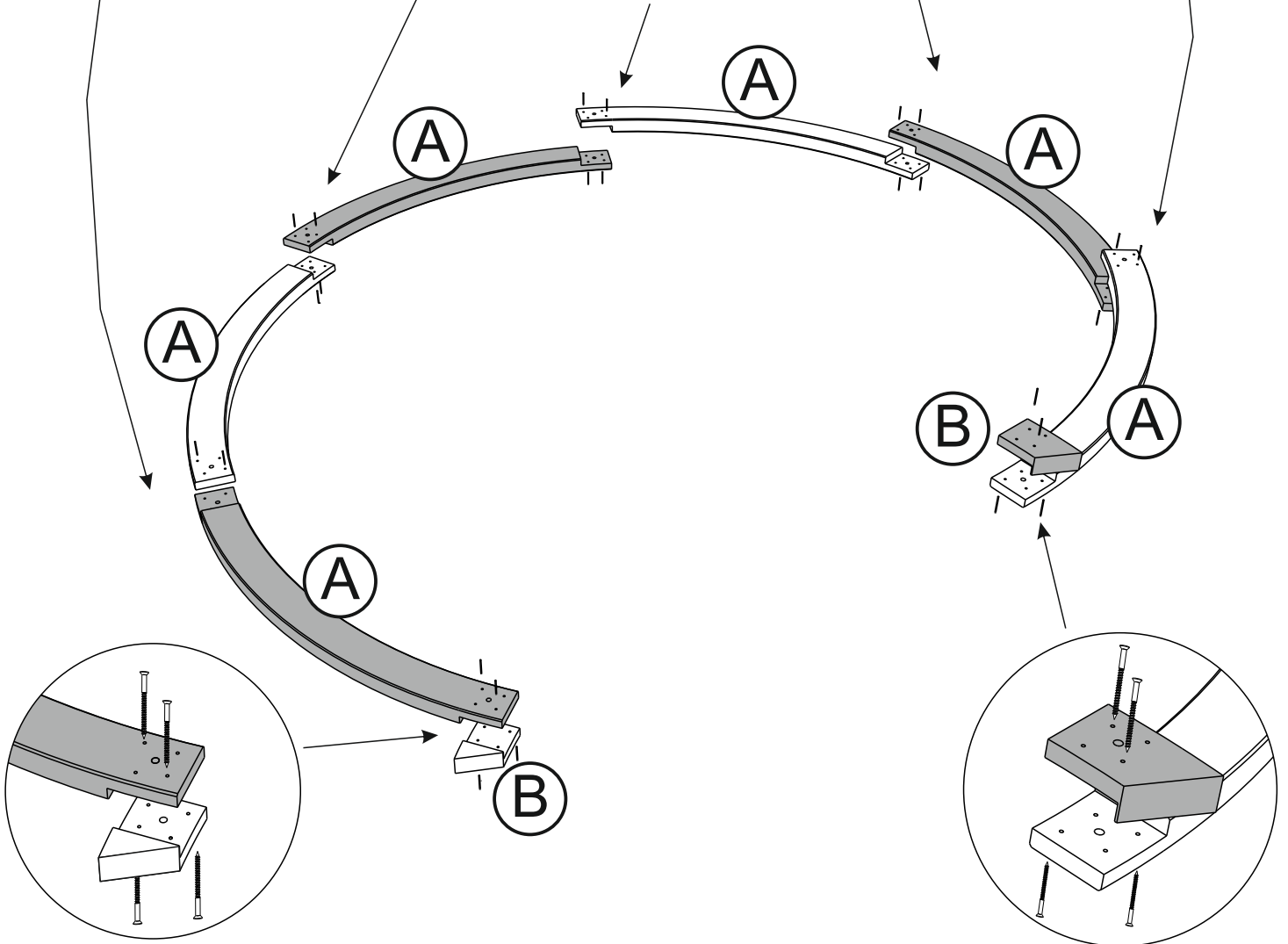
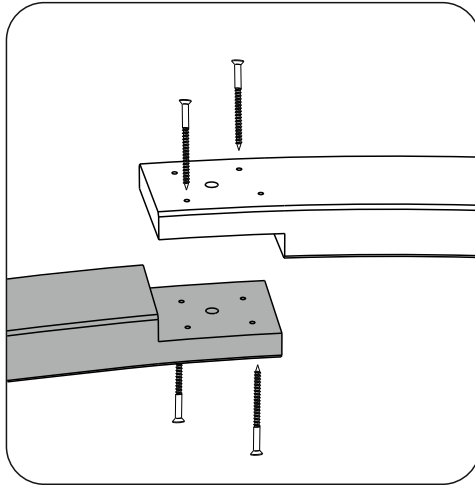

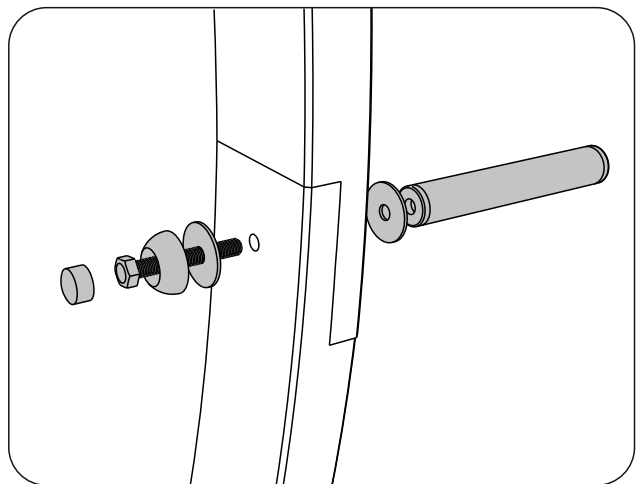
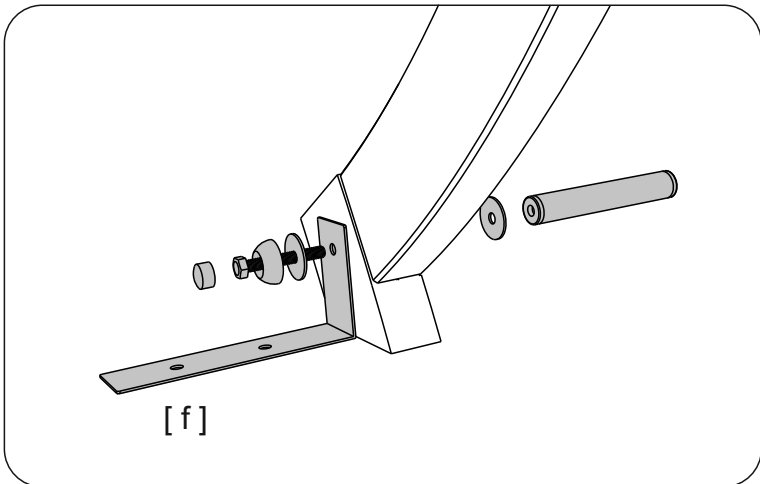
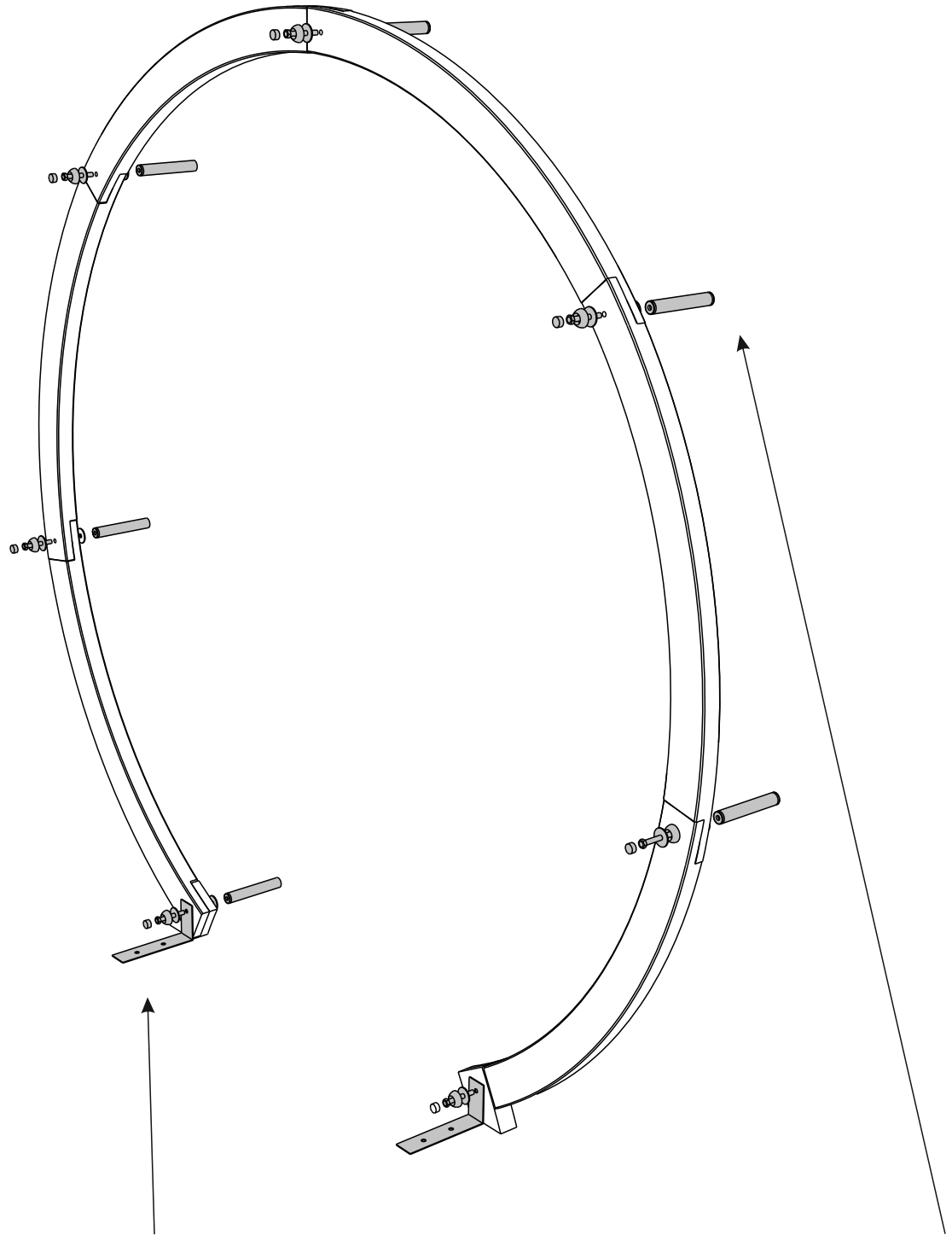

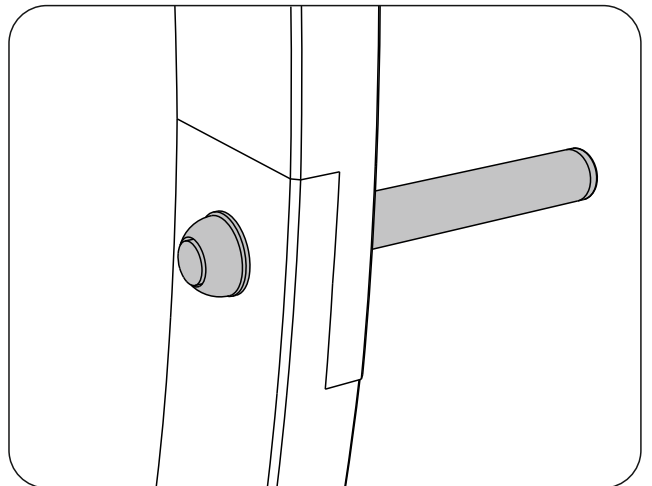
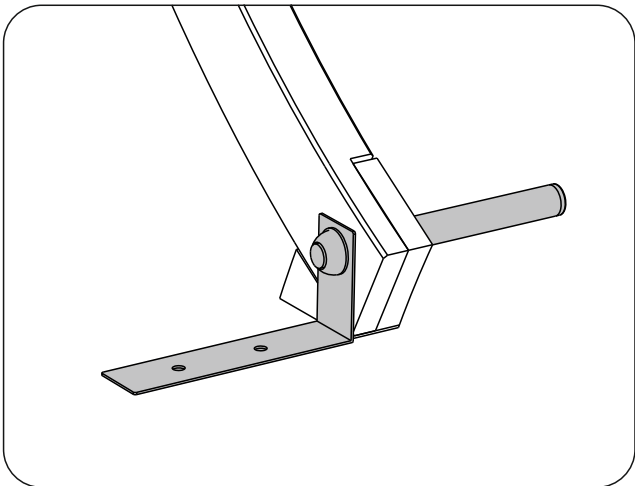
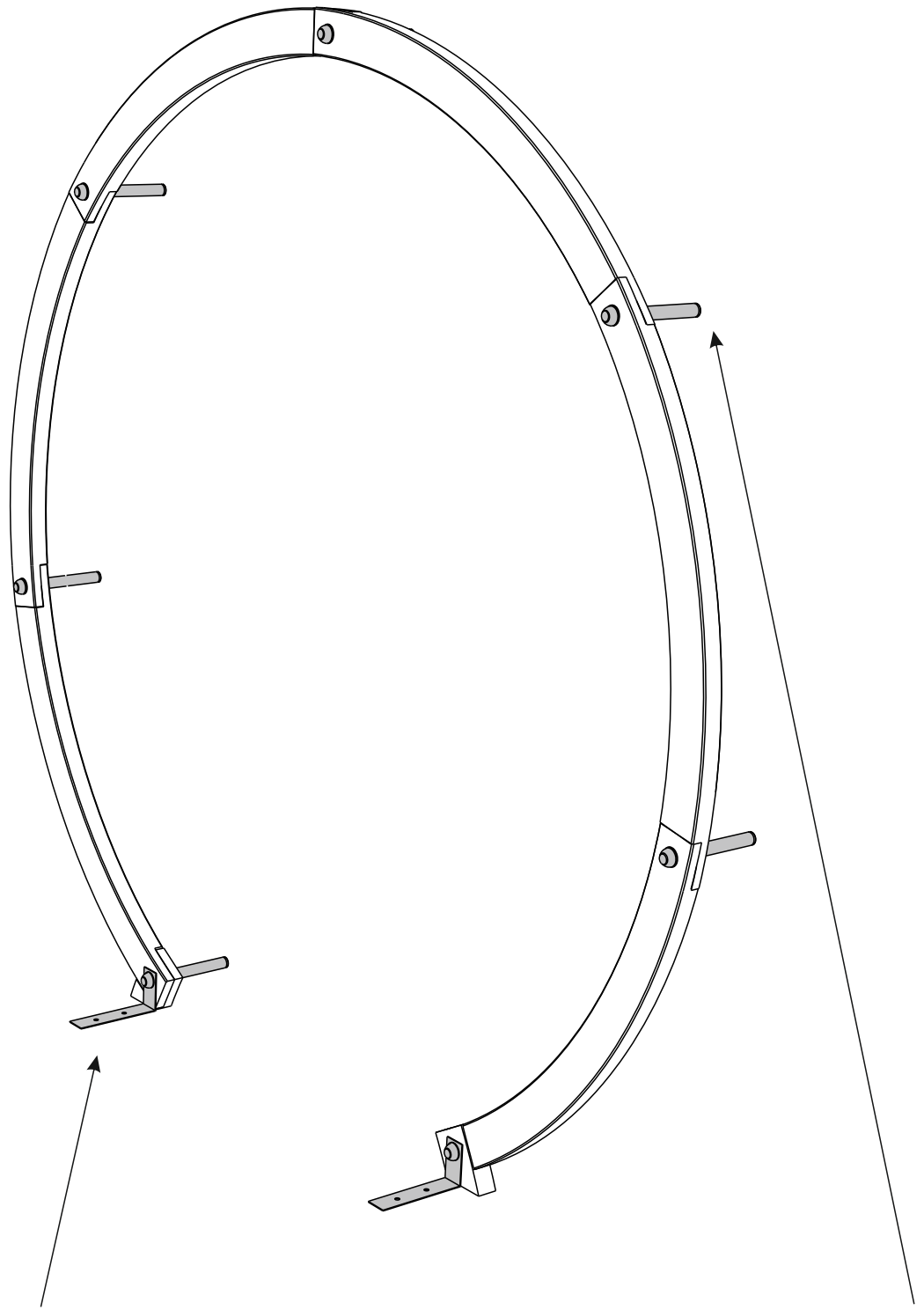

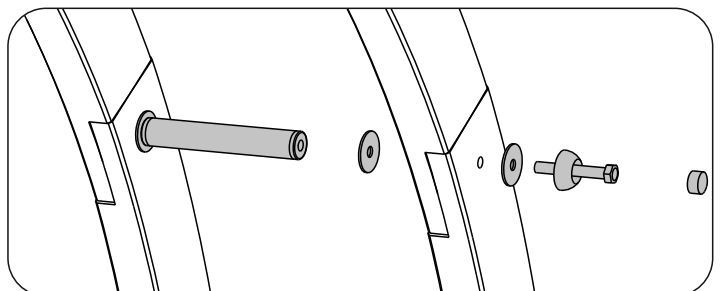
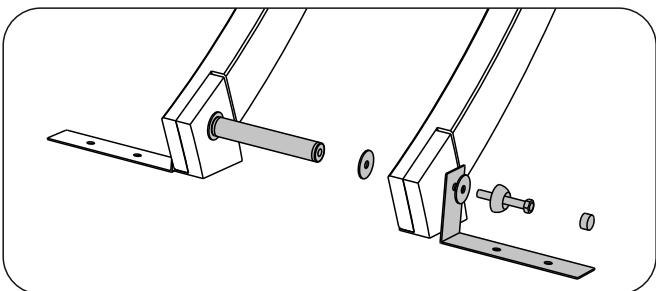
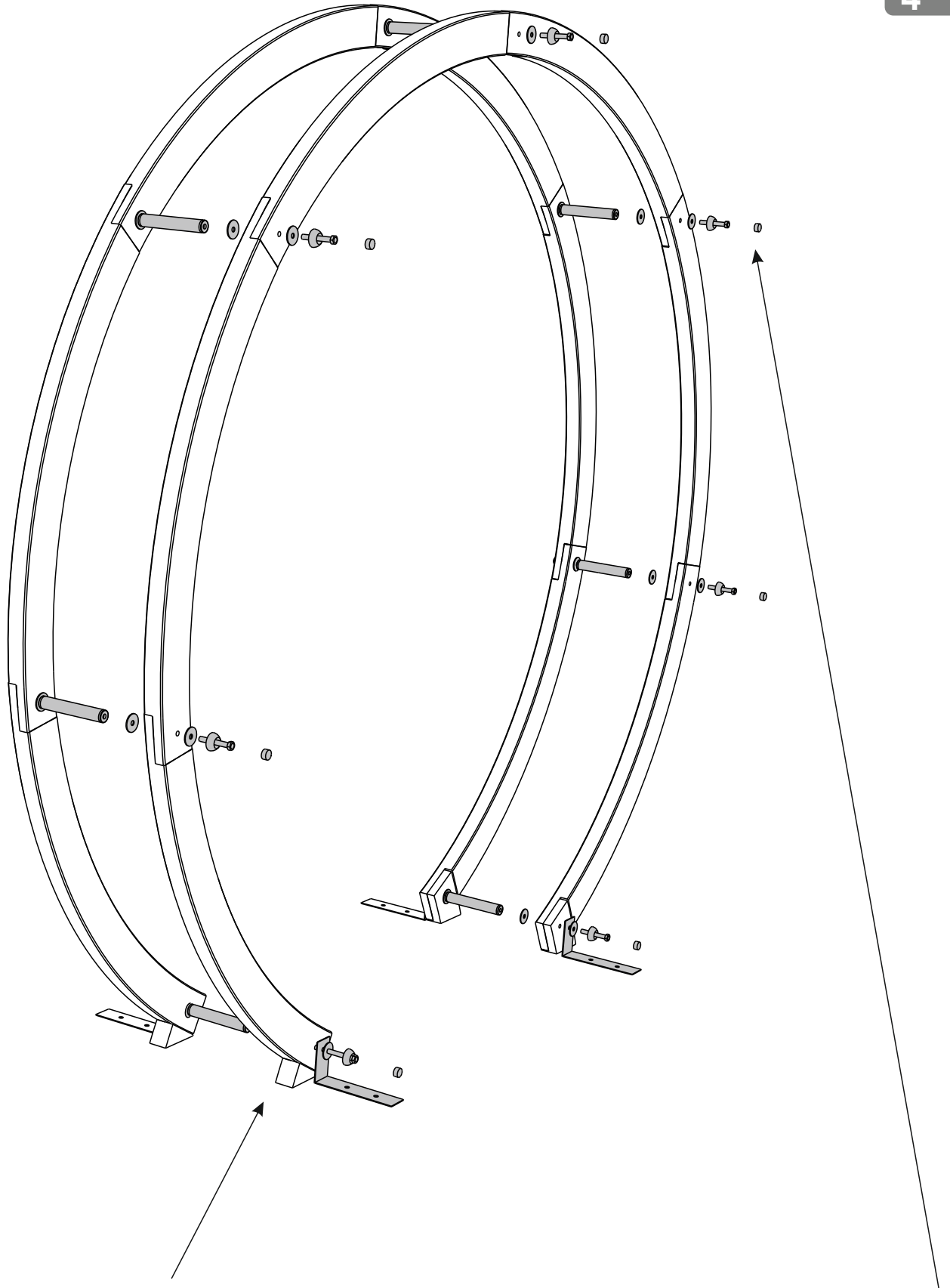

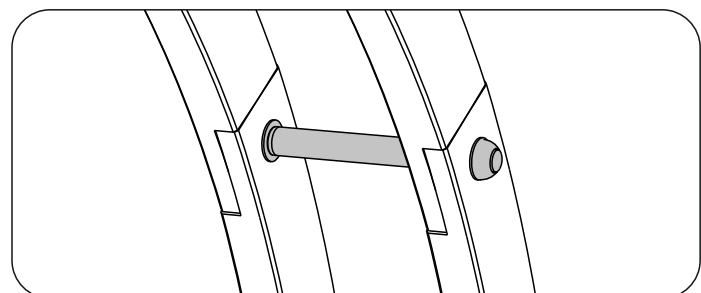
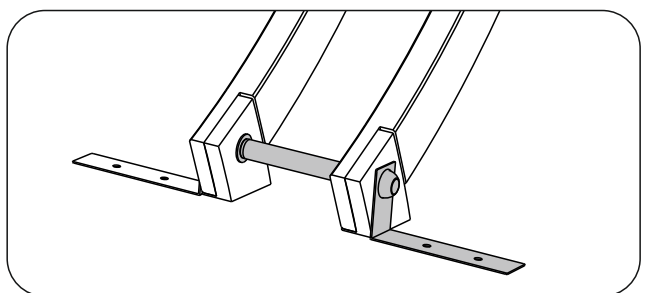
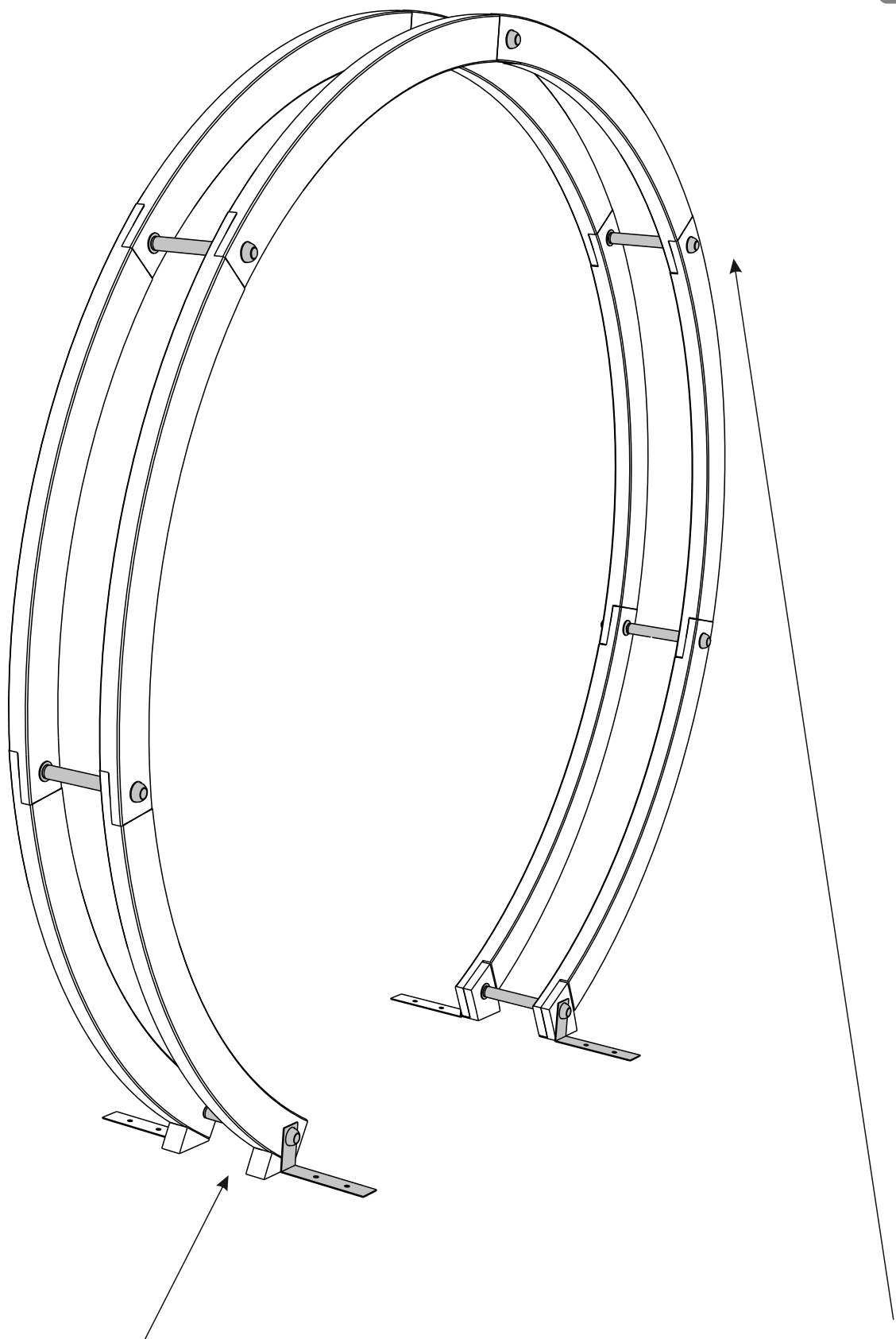

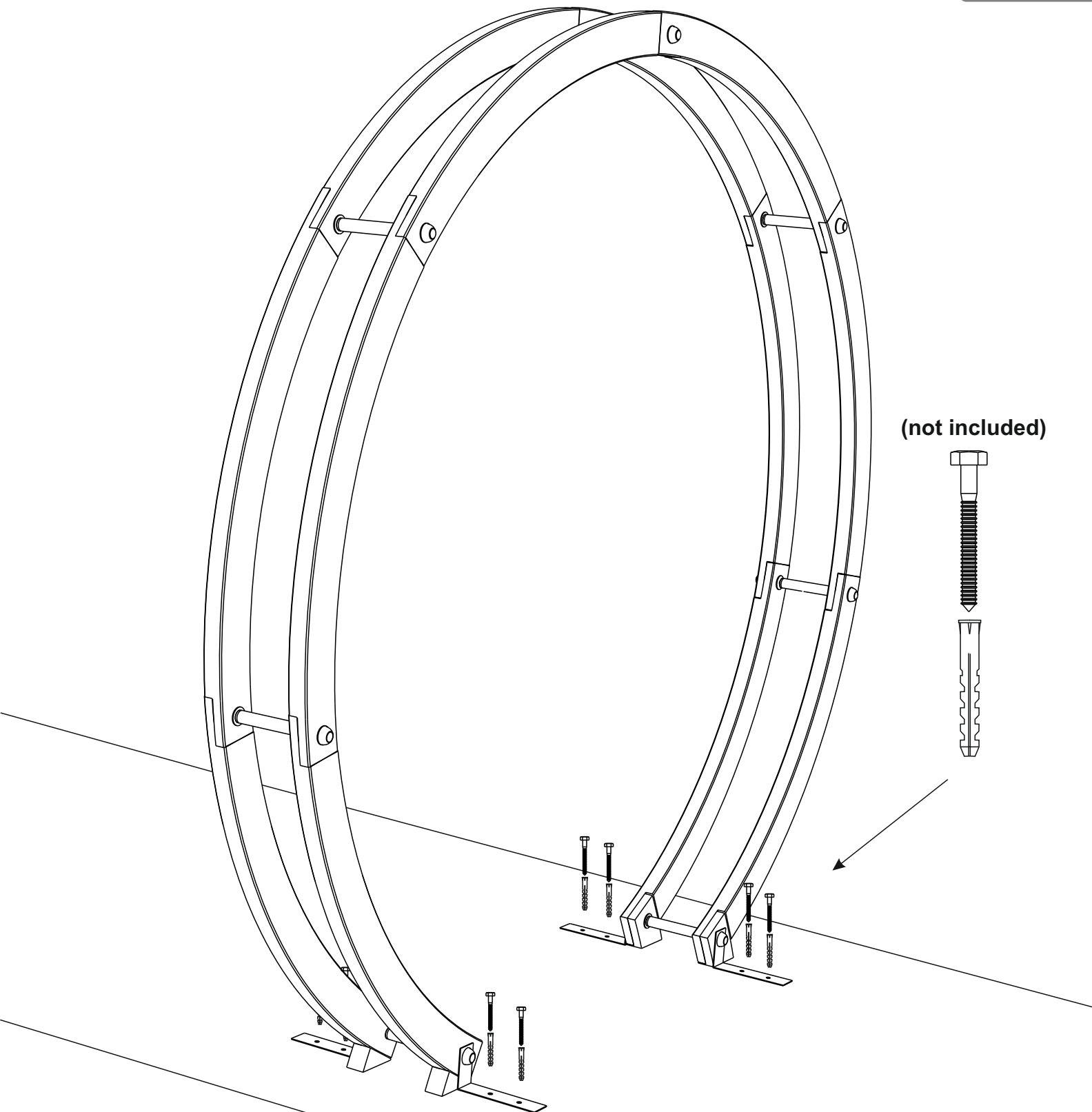
**AFTERCARE**

To ensure longevity of your structure it is recommended that it is treated with a wood preservative on a yearly basis.

Your item is ready!