

BERMUDA



Pond Filter Kit

Pump, filter and UVC package

Instruction Manual

IMPORTANT: Please read this instruction manual carefully before using this product. Keep the manual safe for future reference.

Thank you for purchasing a Bermuda Pond Filter Kit. The Bermuda Pond Filter Kit makes pond filtration easy, including the right pump, filter and ultra violet clarifier to clear water in small to medium garden ponds. The filter box can be part buried for discrete placement, and sponges cleaned at the pull of a handle.

To ensure that this product is safely and correctly used, and at its optimal performance, please read this instruction booklet carefully before use.

Attention

1. Keep out reach of children
2. A drip loop should be installed in both the pump power cable and UV, to ensure that water cannot travel down it, and into an electrical socket.
3. An RCD, (of which the rated working current is not over 30mA) must be installed when using the pump and UV, and the power sockets must be connected to an Earth.
4. The pump included with the Bermuda Pond Filter Kit is designed for outdoor, underwater use only. The filter box and UVC are intended for outdoor use but **MUST NEVER BE PLACED UNDERWATER IN THE POND.** Running the pump dry or placing the pond filter box and UVC in or underwater is strictly prohibited, and may cause irreparable damage, and will invalidate any warranty.
5. The pump and UV must not be used to pump or filter any flammable liquids, or water with a temperature over 35°C.
6. Always disconnect the power supply when handling, servicing or maintaining the pump or UV.
7. Do not attempt to unplug or unwire either pump or UV with wet hands.
8. Do not carry or retrieve the pump, filter box lid or UV by the electrical cables.
9. Power cables to pump and UV cannot be replaced. If damaged or cut too short, discard the unit. Do not attempt to access the electricals inside.

Features

- Pump, filter, UV, hose and clips all included
- Foam free, solids handling pump
- Powerful UV clarifier
- 5 metres of ribbed, kink-free hose
- Mechanical and biological filtration
- Easy to clean sponges
- Filter can be part buried in ground
- Ideal filter system for small ponds containing fish

Usage

Only suitable for outside ornamental garden ponds. Pump and UV can be run continuously, 24 hours per day.

1. The pump should be placed in the pond, in an area where it will be permanently submerged and covered with water.
2. The filter box should be placed pool side, above the water level in the pond.
3. Do not extend the filter box outlet. Box and outlet must be at the highest point in the pond system to work properly. Improper placement, or filter placed too low may cause filter to overflow.
4. Spend 30 minutes checking for leaks after installing pump and filter, and tightening supplied hoseclips.

Filter setup



Step 1 - Familiarise yourself with the fittings. There are two hose clips, the filter tank connector, and a hose tail.



Step 2 - First connect the hose tail to the pump. Turn clockwise by hand until hand tight.



Step 3 - Thread a hose clip over one end of the supplied hose, then thread the hose over the hose tail on pump. Use a screwdriver to tighten clips.



Step 4 - Remove the filter lid by unclipping the plastic fasteners on both sides of the lid.

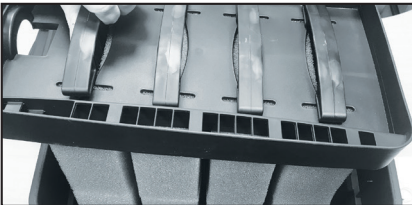

Step 5 - Pull out the tray and attached sponges.

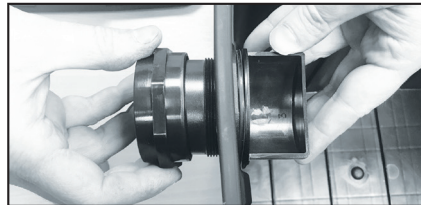

Step 6 - Fit the supplied filter tank connector by poking it through the hole and hand tightening the nut on the other side.



Step 7 - Replace the sponges, tray and re-fit the filter lid.



Step 8 - Thread the other hose clip onto the other end of the hose, slide hose over the hose tail on top, rear of filter box. Tighten with screwdriver.

Pump maintenance

Regularly inspect and clean the pump housing to make sure it has not accumulated too much dirt, leaves and algae on the pump cage. If left, a build-up of leaves and algae will greatly affect the flow of water to the filter. To maintain the pump, and keep it in good working order, use the following instructions.



Step 1 - Remove hose and hose clip, then unscrew the hose tail from the pump body.



Step 2 - Locate the cage clip near the front of the pump cage, press in, and lever cage back, and off.

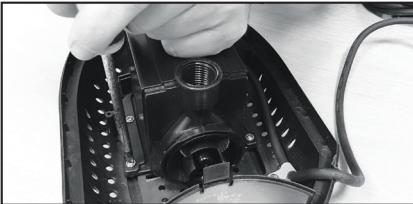

Step 3 - Using a screwdriver (not supplied) unscrew and remove the four screws, to release the pump from the cage.

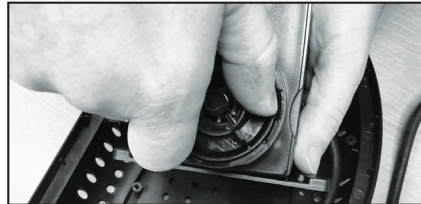

Step 4 - Turn impeller housing anti-clockwise to expose impeller and ceramic shaft.

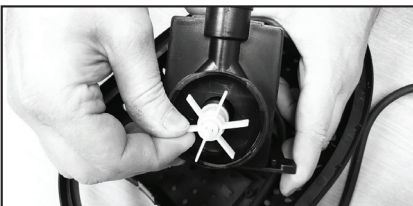

Step 5 - Pull out impeller (held in by magnet) and carefully remove white, ceramic shaft.

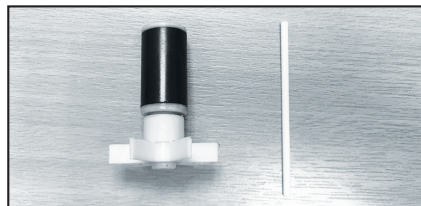

Step 6 - Clean and inspect impeller and shaft. Impeller blades should be intact with no cracks in magnet. Shaft should be in one piece, with no signs of wear. Broken shaft and/or impeller should be replaced at once.

Filter maintenance

6 stage easy cleaning of filter media.



Step 1 - Unclip filter lid.



Step 2 - Remove lid.



Step 3 - Locate media tray and sponges underneath.



Step 4 - Lift out tray and dirty sponges.

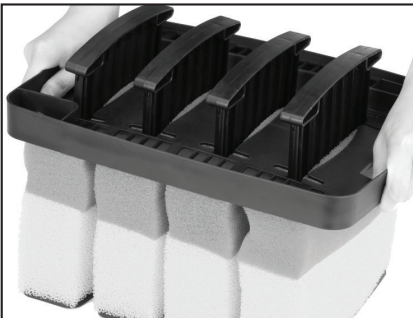

Step 5 - Place tray and sponges away from pond, over garden or a drain.



Step 6 - Pull handles upwards to squeeze dirt from sponges underneath.

UV Clarifier cleaning and replacement



Step 1 - Remove hose from the hosetail on the back of the filter lid.



Step 2 - Unclip and remove lid

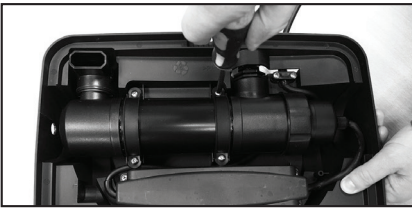

Step 3 - Turn the lid upside down and unscrew the brackets holding the UV in place.



Step 4 - Lift out and remove the UV.



Step 5 - Unscrew the sealing nut at the top of the UV.

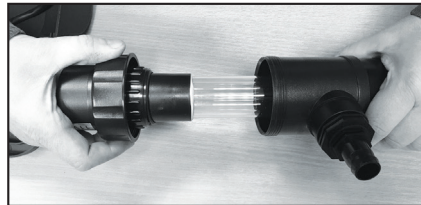

Step 6 - Carefully remove top of unit with attached quartz sleeve and bulb
UNIT MUST BE SWITCHED OFF.

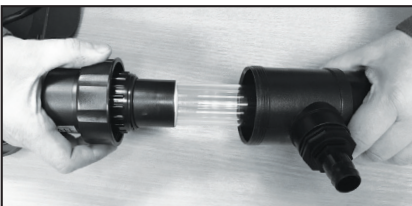

Step 7 - Unscrew the quartz and remove, by turning anti-clockwise. Clean or replace quartz if dirty.

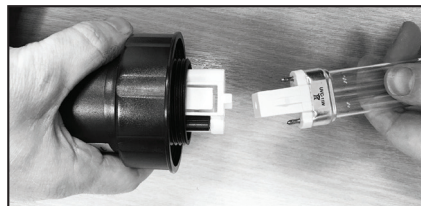

Step 8 - Unclip UV lamp and replace.

Trouble shooting

1. If flow is greatly reduced to filter, check that the pump cage in the pond is not blocked with leaves and filamentous algae. Check that the hose is not kinked or blocked, and that the hose tails at each are not blocked with debris.
2. If the water turns green, check that the UV is plugged in and running 24 hours per day. If more than six months old the lamp will need replacing. Check that the quartz sleeve is clean and clear, to allow the UV light to penetrate the water.
3. If filter sponges do not spring back after cleaning, replace old sponges for new.
4. If water is spilling over the inner plastic tray, the sponges are blocked and need cleaning or replacing.
5. If water is overflowing from the filter box, the box has been located incorrectly to the pond, or has been connected to a vastly oversized pond pump.
6. The filter box outlet (which returns water to the pond,) must always be at the highest point, i.e. higher than the water level of the pond, or if intended to feed a watercourse, it must be at the highest point of the watercourse.

Specifications

MODEL	BER CODE	MAX. POND VOLUME	PUMP OUTPUT	PUMP WATTAGE	UV POWER
6000	BER0401	6,000 litres / 1,320 gallons	1,500lph	25W	9W
9000	BER0402	9,000 litres / 1,980 gallons	2,000lph	43W	11W

Exploded view - Filters

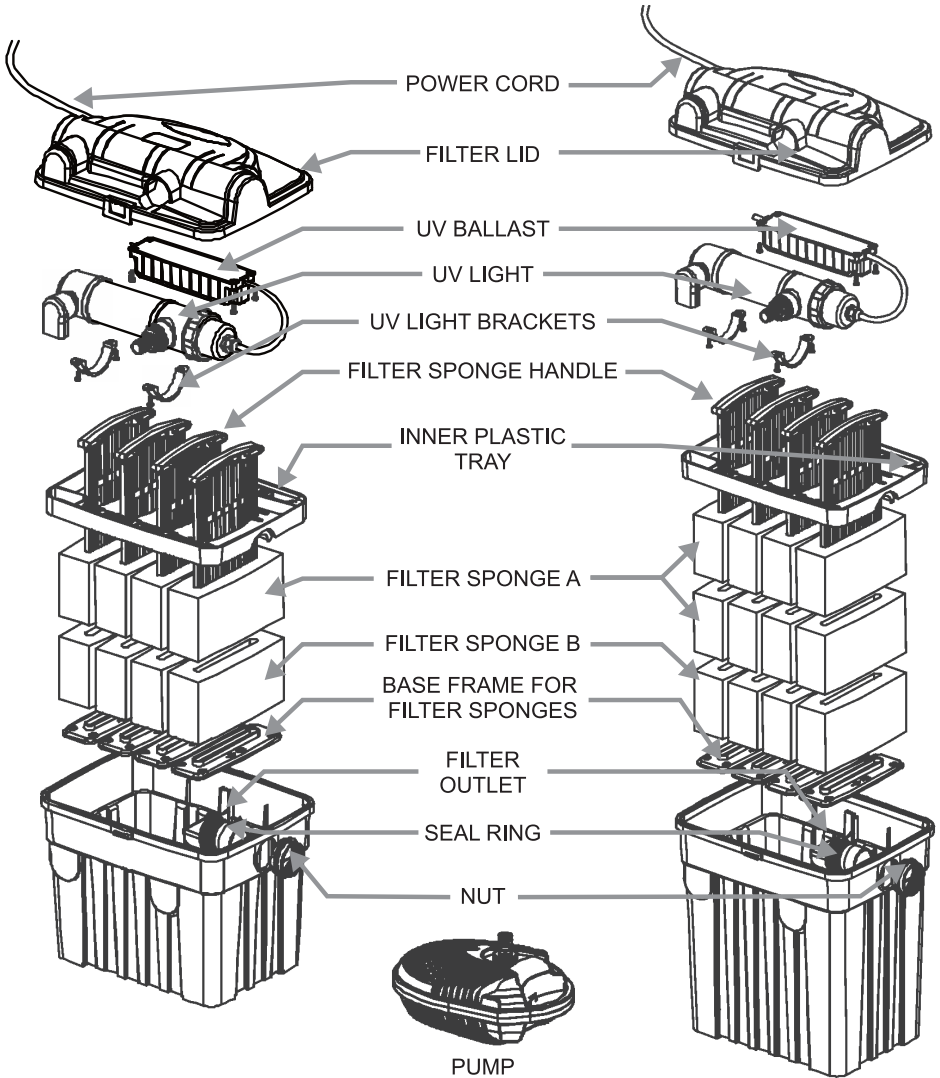

FILTER KIT 6000

FILTER KIT 9000

Exploded view - Pump

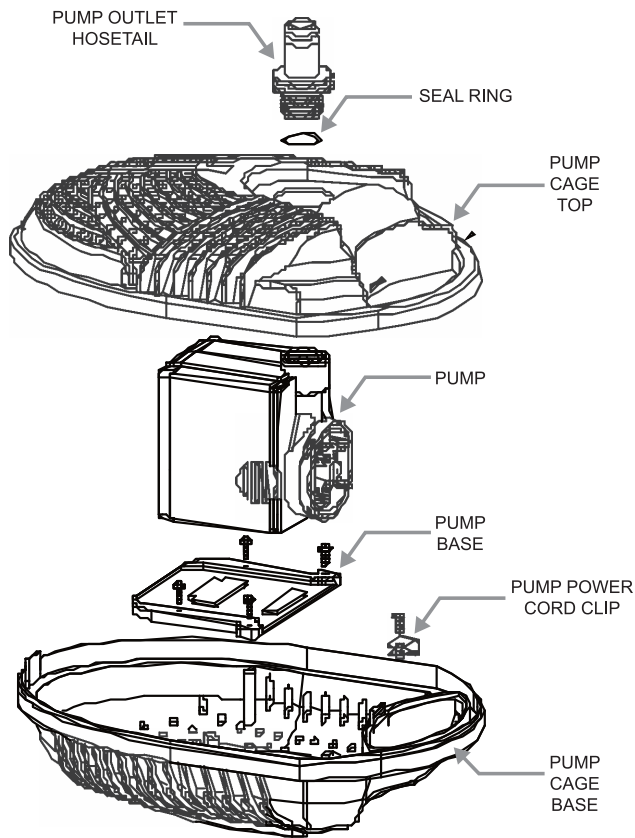

Exploded view - UVC

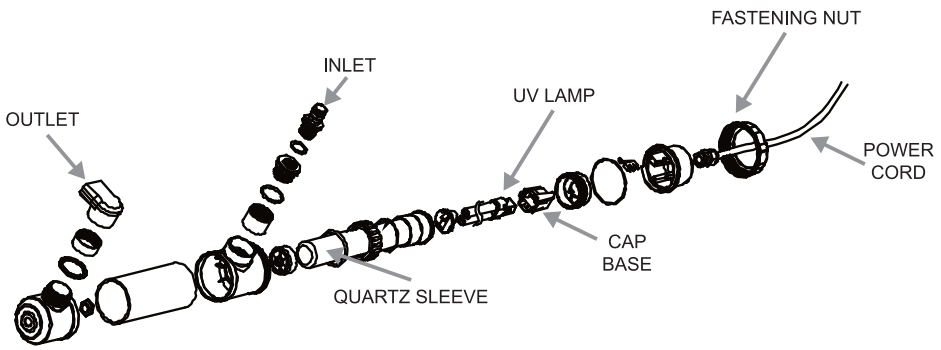

Guarantee

This product is guaranteed against defects in material and workmanship for **one year** from the date of purchase, under normal usage.

The guarantee **DOES NOT APPLY** in case of improper use, negligence, lack of maintenance or accidental damage to the pump. If the pump fails due to a manufacturing fault within this period it will be either repaired or replaced free of charge. Moving parts or wearable parts including the impeller and any washers or O rings, also quartz sleeves and UV bulbs are not covered by the guarantee and are available to order from your Bermuda retailer.

Should your Bermuda product stop working refer first to trouble shooting and if this does not help, return the product to the place of purchase.

Liability is limited to replacement of the faulty product only. No other costs will be reimbursed. This guarantee is not transferable and does not affect your statutory rights.

Do not attempt to tamper with or access electrical components inside the pump body. Doing so will invalidate the warranty.

The manufacturer or supplier shall not be responsible, or held liable for any damages caused by defective components or materials of this product, or for loss incurred by interruption of service, or any consequential/incidental damages and expenses arising from the production, sale use or misuse of this product or any other consequential loss.

Any warranty claim must be accompanied by a valid, dated proof of purchase. Evolution Aqua, Bermuda, its distributors and dealers shall not be held liable for any loss of fish, plants or any other livestock as a result of any failure or defect of this product.

The installation and use of your product outside of our recommendations as printed in this manual may also void the warranty.



www.bermudawatergardens.com

BERMUDA an Evolution Aqua brand.
Evolution House, Kellet Close, Wigan, Lancashire, WN5 0LP

DISTRIBUTED BY: Certikin, Witan Park, Avenue 2,
Station Lane Industrial Estate, Witney, Oxfordshire, UK, OX28 4FJ