

BERMUDA



MultiPump

All in one pump, filter, and UV
Instruction Manual

IMPORTANT: Please read this instruction manual carefully before using this product. Keep the manual safe for future reference.

Thank you for purchasing a Bermuda MultiPump. MultiPump combines many great features including biological and mechanical filtration, a UV clarifier, and fountain into one neat, compact unit, perfect as a complete filtration system for small ponds. To ensure that this product is safely and correctly used and at its optimal performance, please read this instruction booklet carefully before use.

Attention

1. Keep out of the reach of children.
2. A drip loop should be installed in the cable, to ensure that water cannot travel down it and into an electrical socket.
3. An RCD (of which the rated working current is not over 30mA) must be installed when using the pump, and the power socket must be connected to an earth.
4. Bermuda MultiPump is designed for underwater use only. Running the pump dry, without water inside the pump, is strictly prohibited. Dry running may also cause irreparable damage, and invalidate any warranty.
5. The device must not be used to pump any flammable liquids or water with a temperature higher than 35°C.
6. Always disconnect the power supply when handling, servicing or maintaining the pump.
7. Do not attempt to unplug the pump or disconnect from the power supply with wet hands.
8. Do not carry or retrieve the pump from the pond by pulling the electrical cable.
9. If the power cable becomes damaged near to the pump body it cannot be replaced, and electricals are sealed inside the unit to make them waterproof.

Features

- Built in ultra violet clarifier to tackle green water
- Sponges for mechanical filtration
- Plastic and ceramic media for biological filtration
- Height and angle adjustable riser stem
- Fountain flow control

Usage

Suitable for outdoor ornamental garden ponds only. Can be run continuously, 24 hours per day.

1. The device should be placed in the centre of the pond. A hose can be connected to the supplied hosetail, if a small water feature is required instead of or as well as a small fountain.
2. The fountain riser stem is angle adjustable. This enables a vertical fountain, even if the pond base is not level.
3. When first connected to the power, spend 30 minutes checking that the pump is running as it should, steady, normal, and without any abnormal flow, or fault. Check connections to filter to ensure there are no leaks.

MultiPump - Fountain Installation

TYPICAL SET UP

The picture shows a typical MultiPump set-up, with fountain and riser stem extensions fitted.

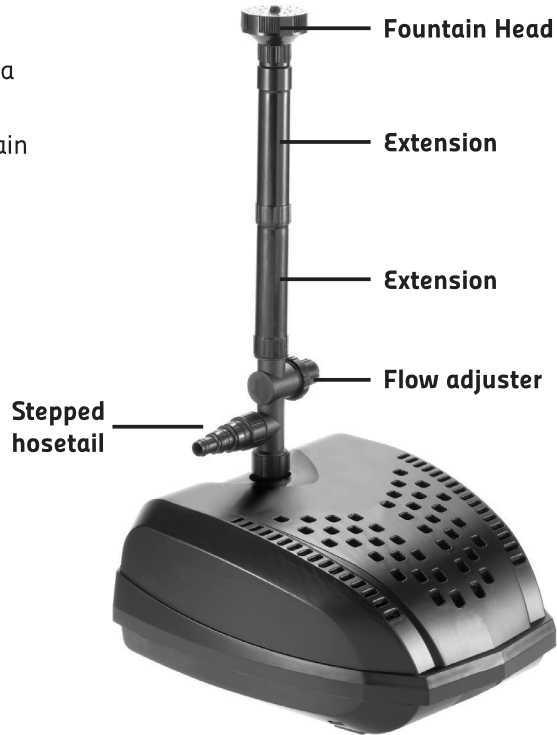

ALTERNATIVE SET UP

A bell jet can be fitted, along with the universal angle adjuster, to make any fountain straight and vertical.

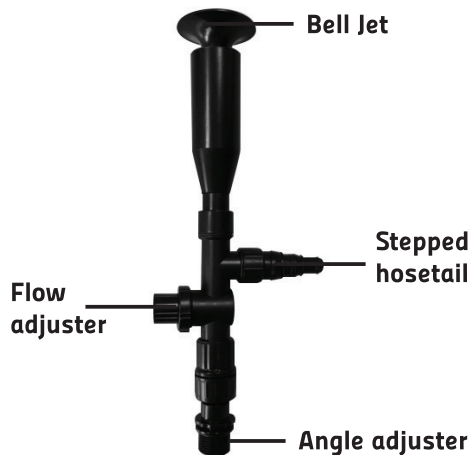

MultiPump - Filter Maintenance



Step 1 - Remove top cover by squeezing two side clips.



Step 2 - Remove filter sponges and media for easier access.



Step 3 - Remove bag of ceramic stones and bio-balls filter media.

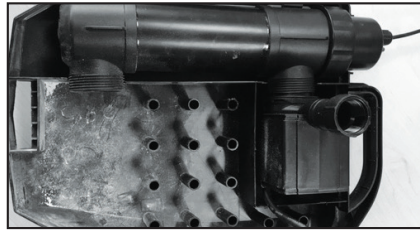

Step 4 - Clean all sponges and filter media using pond water.



Step 5 - Carefully replace bio-balls bag of ceramic stones.



Step 6 - Replace filter sponges and clip the pump cover back on.



Step 7 - Refit the pump cover.

MultiPump - UVC Maintenance



Step 1 - Remove top cover by squeezing two side clips.



Step 2 - Remove filter sponges and media for easier access.



Step 3 - Remove UV from clips.



Step 4 - Unscrew bulk head.

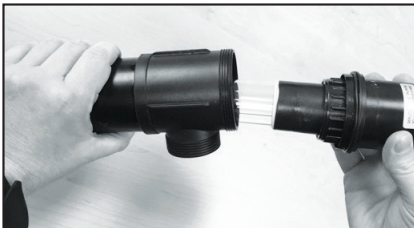

Step 5 - Carefully remove lamp and quartz sleeve.

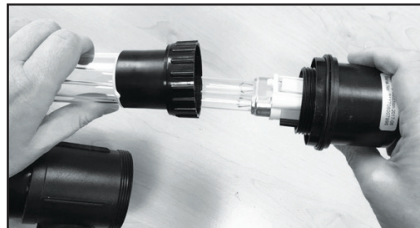

Step 6 - Carefully unscrew and remove UV bulb from quartz sleeve.

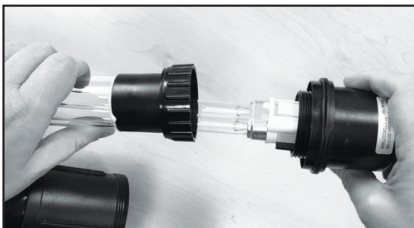

Step 7 - If UV bulb is not working, carefully fit a new bulb.



Step 8 - Reverse previous steps to re-fit UV back into pump body.

MultiPump - Pump Cleaning



Step 1 - Remove top cover by squeezing two side clips.

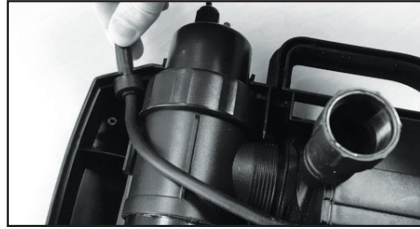

Step 2 - Remove the pump wire from the clip.

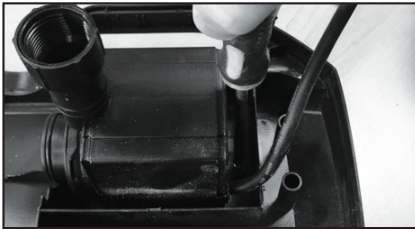

Step 3 - Unscrew three screws from the base of the pump to remove it.



Step 4 - Turn the impeller housing anti-clockwise to expose the impeller.



Step 5 - Carefully remove the impeller and central, ceramic shaft.

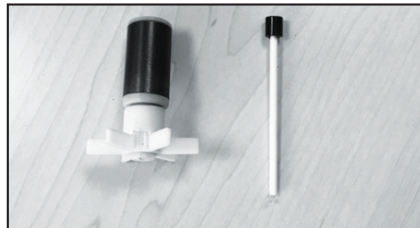

Step 6 - Inspect the shaft and make sure it is clean and in one piece.

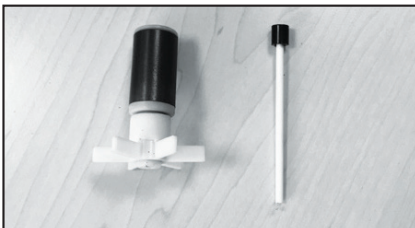

Step 7 - Clean the impeller, check it is not cracked and blades are intact.

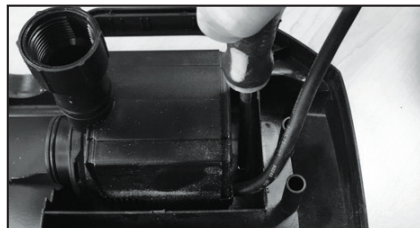

Step 8 - Reverse previous steps to refit the pump.

Trouble shooting

1. If the pump is not working after being connected, please check if the plug is loose, if it has been properly wired into the plug, RCD plug or outdoor switchbox, and that the plug and cable are not damaged. Never dismantle the pump by yourself if malfunction occurs. Check that the RCD has been reset and power to outdoor electrical sockets is switched on, and not tripped or fused.
2. If the motor of the pump is running but with less water flow or water pressure, check that the pump housing is not already blocked by too much dirt and leaves, and that the Head Max (height of water it is pumping to) has not been exceeded.
3. Check that there is sufficient water in the water feature reservoir to ensure that the pump is under water at all times.
4. If the UV light does not work, check the power, check the bulb and check the power adapter. Replacement UV bulbs and quartz sleeves can be purchased from your Bermuda retailer.
5. If the fountain is not working, check first that the tiny holes in the rose are not blocked with debris and algae. Clean if necessary, and regularly, from then on. Check also that you have opened flow to the fountain on the flow adjuster (see page 4 diagram)
6. If pond water goes green, check that the UV Clarifier is plugged in and switched on. A red LED indicator is visible on the UV outer casing, to show that the lamp is on and working. Do not look at the UV light when switched on. If the UV has been plugged in and running continuously for six months, the UV bulb will need to be changed. Obtain a replacement UV bulb from your Bermuda retailer (not covered under warranty,) and follow the instructions on page 7 of this manual.

Exploded view

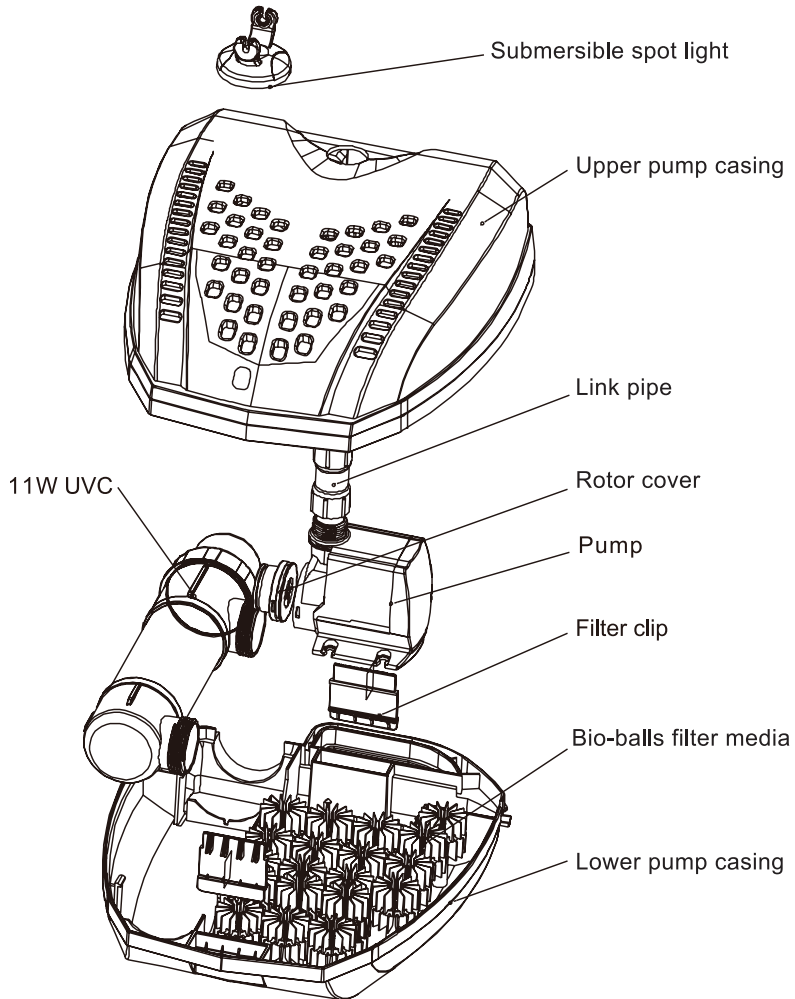

Specifications

MODEL	BER CODE	PUMP OUTPUT	POWER	MAX HEIGHT	UV LIGHT
MULTI PUMP	BER0622	2,000lph / 440gph	45 W	2.0m	11 W



Guarantee

This product is guaranteed against defects in material and workmanship for **one year** from the date of purchase, under normal usage.

The guarantee **DOES NOT APPLY** in case of improper use, negligence, lack of maintenance or accidental damage to the pump. If the pump fails due to a manufacturing fault within this period it will be either repaired or replaced free of charge. Moving parts or wearable parts including the impeller and any washers or O rings, also quartz sleeves and UV bulbs are not covered by the guarantee and are available to order from your Bermuda retailer.

Should your Bermuda product stop working refer first to trouble shooting and if this does not help, return the product to the place of purchase.

Liability is limited to replacement of the faulty product only. No other costs will be reimbursed. This guarantee is not transferable and does not affect your statutory rights.

Do not attempt to tamper with or access electrical components inside the pump body. Doing so will invalidate the warranty.

The manufacturer or supplier shall not be responsible, or held liable for any damages caused by defective components or materials of this product, or for loss incurred by interruption of service, or any consequential/incidental damages and expenses arising from the production, sale use or misuse of this product or any other consequential loss.

Any warranty claim must be accompanied by a valid, dated proof of purchase. Evolution Aqua, Bermuda, its distributors and dealers shall not be held liable for any loss of fish, plants or any other livestock as a result of any failure or defect of this product.

The installation and use of your product outside of our recommendations as printed in this manual may also void the warranty.





www.bermudawatergardens.com

BERMUDA an Evolution Aqua brand.
Evolution House, Kellet Close, Wigan, Lancashire, WN5 0LP

DISTRIBUTED BY: Certikin, Witan Park, Avenue 2,
Station Lane Industrial Estate, Witney, Oxfordshire, UK, OX28 4FJ