



**Technical Details**  
**CLASSIC & PREMIUM SERIES**

**May 2023**

# CLASSIC SERIES

## BEEFEATER 3000 Series 4 Burner BBQ Outdoor Kitchen

Front View

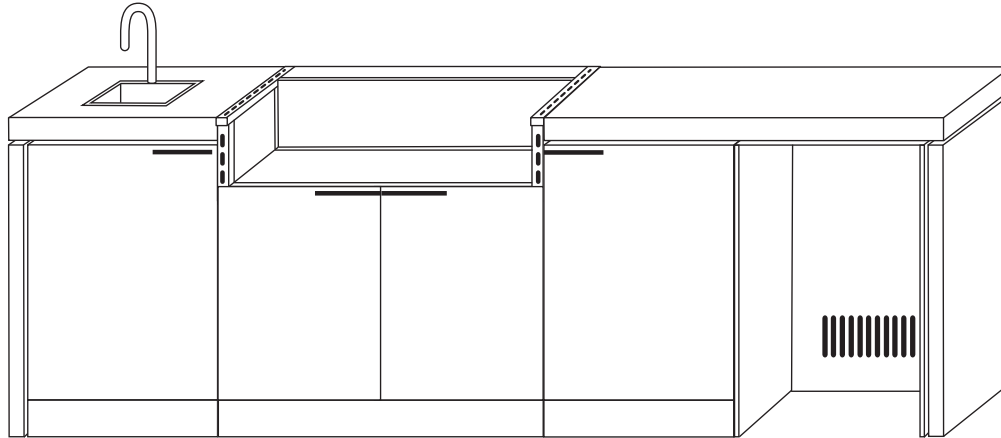

BBQ Module -  
885mm

Premium Bar Fridge  
SC-108FS (SC-108F)

## BEEFEATER 3000 Series 5 Burner BBQ Outdoor Kitchen

Front View

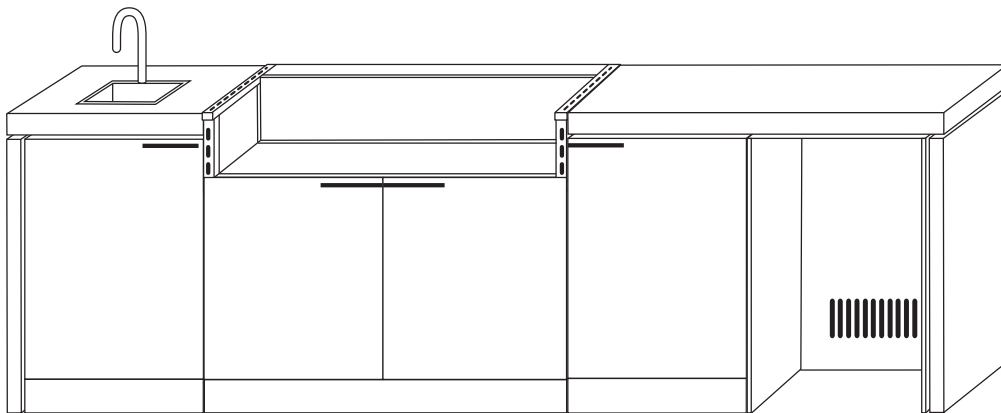

BBQ Module -  
1045mm

Premium Bar Fridge  
SC-108FS (SC-108F)



### OPTIONAL ACCESSORY

Front View

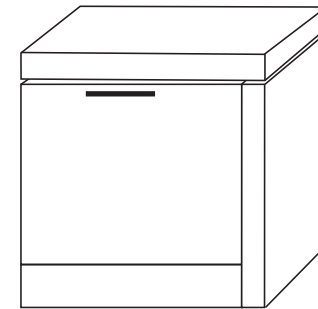

Kamado Joe Module

# CLASSIC SERIES

## BEEFEATER Proline 6 Burner Classic Outdoor Kitchen



Front View

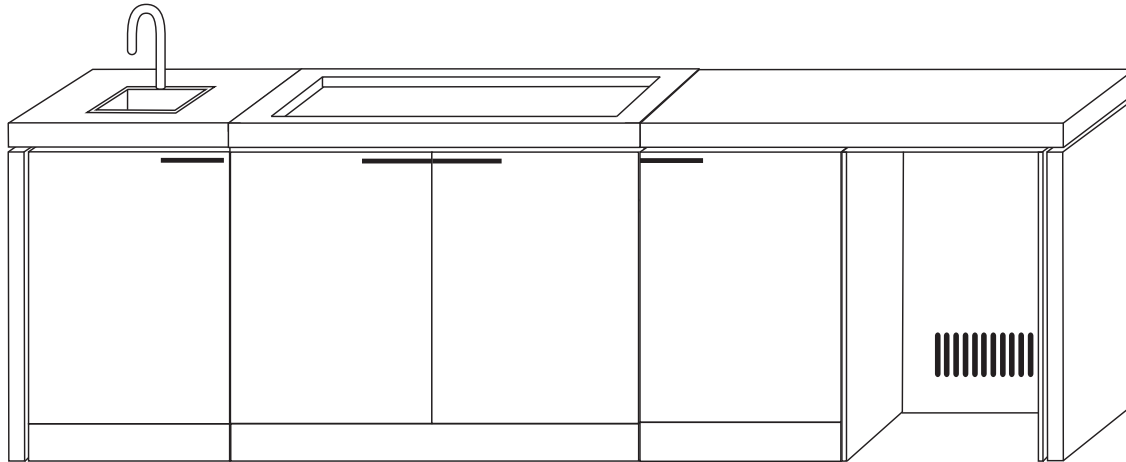

▲  
BBQ Module -  
1165mm

▲  
Premium Bar Fridge  
SC-108FS (SC-108F)

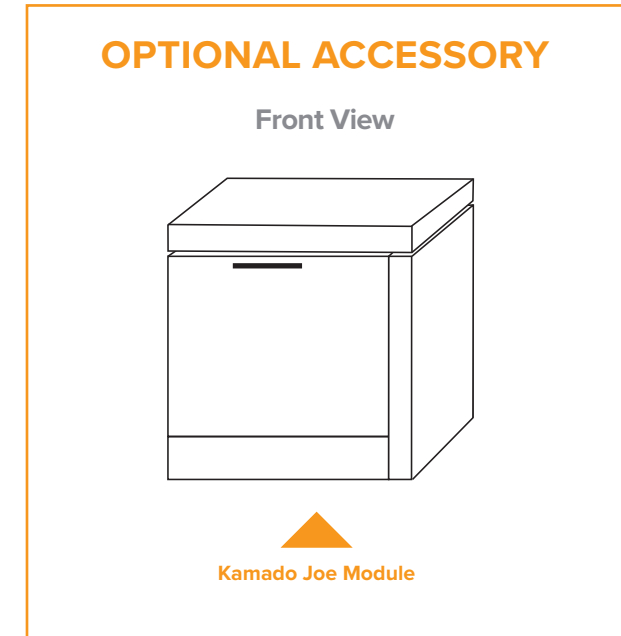

# CLASSIC SERIES

## Modules

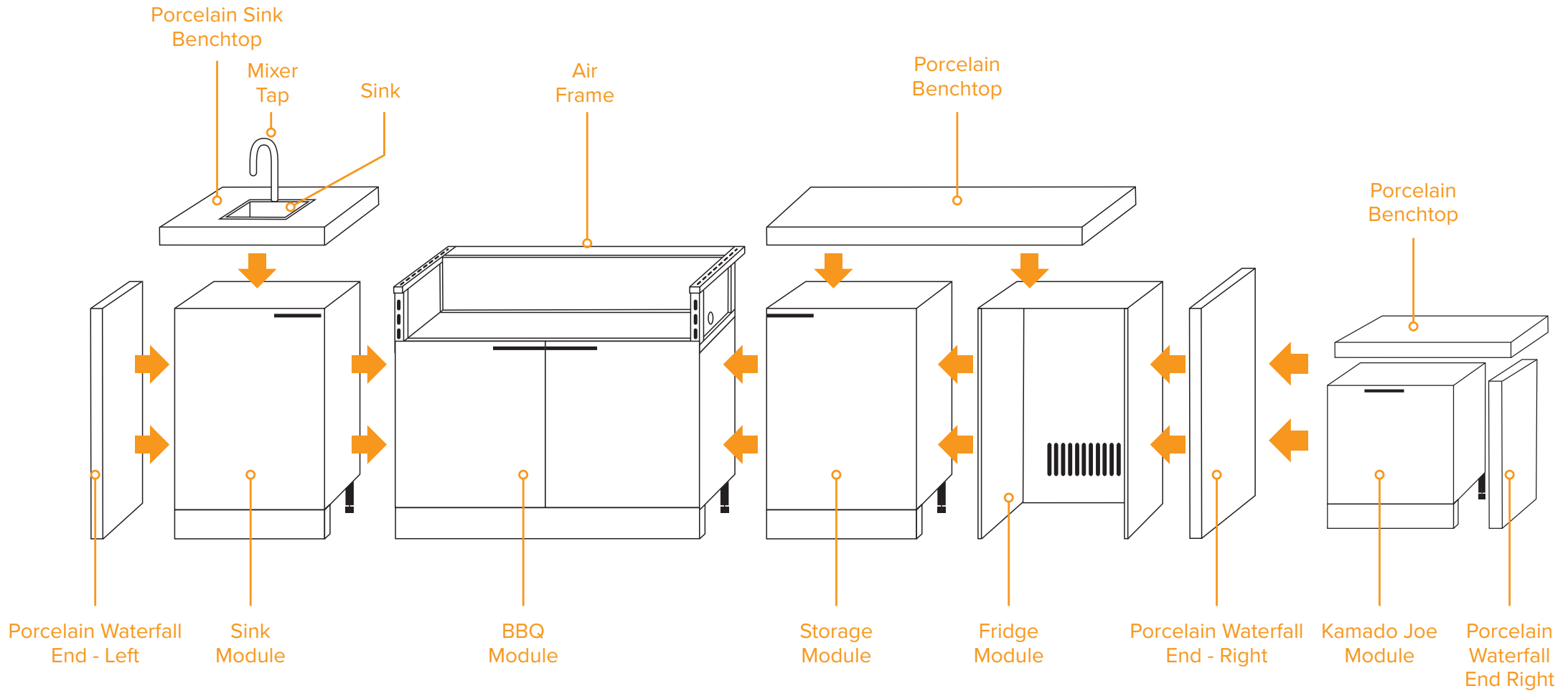

# CLASSIC SERIES

## BBQ Modules and Air Frame

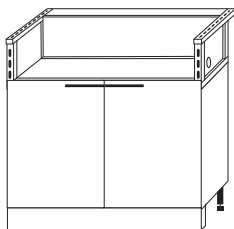

### BBQ Module & Air Frame - 885mm

- 885mm (W) x 670mm (D) x 570mm (H)
- 950mm total max height including adjustable feet and Air Frame
- Internal width of Air Frame: 825mm W
- BBQ: BEEFEATER 3000 Series 4 Burner
- COLOUR: Cadet Grey

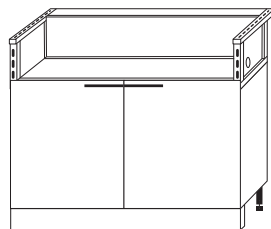

### BBQ Module & Air Frame - 1045mm

- 1045mm (W) x 670mm (D) x 570mm (H)
- 950mm total max height including adjustable feet and Air Frame
- Internal width of Air Frame: 985mm W
- BBQ: BEEFEATER 3000 Series 5 Burner
- COLOUR: Cadet Grey

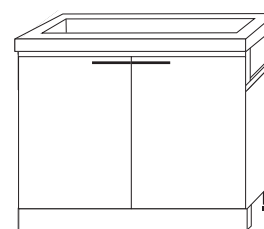

### BBQ Module - 1165mm

- 1165 (W) x 670 (D) x 770mm (H)
- 950mm total max height including adjustable feet and top
- BBQ: BEEFEATER Proline 6 Burner Flatlid and BEEFEATER Proline 6 Burner Roaster
- COLOUR: Cadet Grey

## Modules

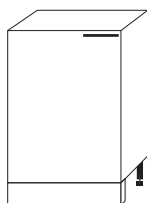

### Sink Module

- 550mm (W) x 670mm (D) x 770mm (H)
- 950mm total max height including adjustable feet and Top
- Top: 730mm deep to allow for services\* (see note below)
- COLOUR: Cadet Grey

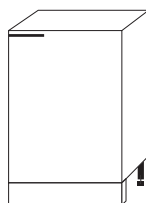

### Storage Module

- 550mm (W) x 670mm (D) x 770mm (H)
- 950mm total max height including adjustable feet and Top
- Top: 730mm deep to allow for services\* (see note below)
- COLOUR: Cadet Grey

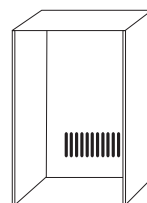

### Fridge Module

- 550mm (W) x 670mm (D) x 770mm (H)
- 950mm total max height including adjustable feet and Top
- Top: 730mm deep to allow for services\* (see note below)

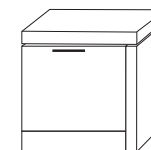

### Kamado Joe Module

- 610 (W) x 730 (D) x 425mm (H)
- 545mm total max height including adjustable feet and top
- Top 730mm to match other modules
- COLOUR: Cadet Grey

*\*NOTE: Benchtops are deeper than the cabinets to allow for services (hot and cold plumbing, electrical cords and drainage) to run behind the outdoor kitchen when assembled. The legs on each module are designed to be adjusted for levelling.*

# CLASSIC SERIES

## Porcelain Benchtops

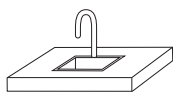

### Benchtop to suit Sink Module - 610mm

- 610mm (W) x 730mm (D) x 60mm (H)
- COLOUR: Porcelain Black



### Benchtop to suit Storage and Fridge Module - 1160mm

- 1160mm (W) x 730mm (D) x 60mm (H)
- COLOUR: Porcelain Black



### Benchtop to suit BEEFEATER Proline 6 Burner BBQ Module

- 1165 (W) x 730mm (D) x 60mm (H)
- Colour: Porcelain Black

## End Panels



### Porcelain Waterfall End - Left

- 60mm (W) x 730mm (D) x 865mm (H)
- COLOUR: Porcelain Black



### Porcelain Waterfall End - Right

- 60mm (W) x 730mm (D) x 865mm (H)
- COLOUR: Porcelain Black

## Sink & Mixer Tap



### Sink Module

Sink to suit Sink Module. Matte Black sink is made from premium materials for a more robust finish and design.

- 450mm x 300mm x 200mm
- COLOUR: Matte Black finish



### Sink Module - Mixer Tap

Mixer Tap to suit Sink Module. Matte Black Mixer Tap gives your outdoor kitchen a modern, contemporary look and feel. The outdoor kitchen mixer tap is designed for full hands, the long spout enables you to use your elbow if you need to move the spout out of the way. The 360° swivel function makes this an efficient tap for your outdoor kitchen.

- COLOUR: Matte Black finish

## Planning and location of water, waste, power and gas services.

Preparing and checking the installation location is important to ensure the modular kitchen assembly and installation is as smooth as possible.

Ideally the floor surface should be level, clean and suitable for the cabinet installation along with water, waste, power and gas services, being able to be roughed in and compliant with all required with all required local government standards.

The services being roughed in should be left long enough to enable them to be fitted off inside the relevant cabinets after they have been installed.

*\*Note: All plumbing and electrical work must be done by a registered trades person.*



# PREMIUM SERIES

## BEEFEATER 3000 Series 4 Burner BBQ Outdoor Kitchen

Front View

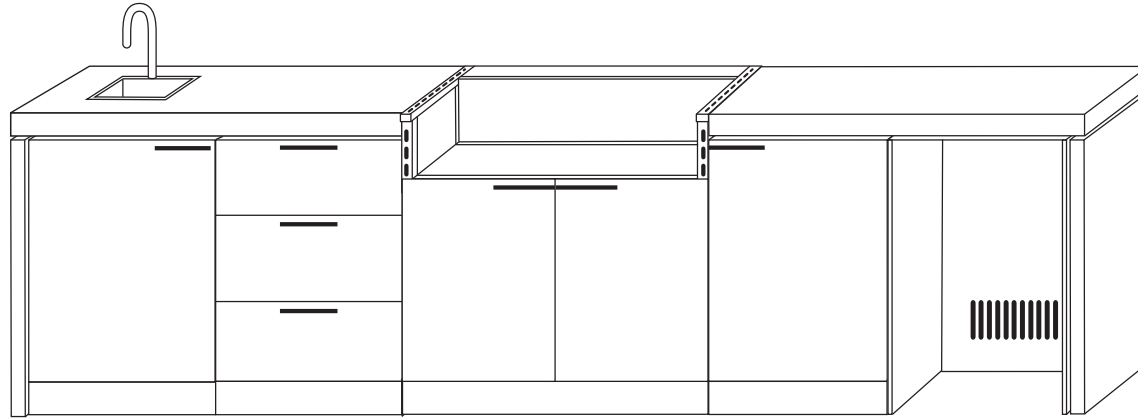

BBQ Module -  
885mm

Premium Bar Fridge  
SC-108FS (SC-108F)

## BEEFEATER 3000 Series 5 Burner BBQ Outdoor Kitchen

Front View

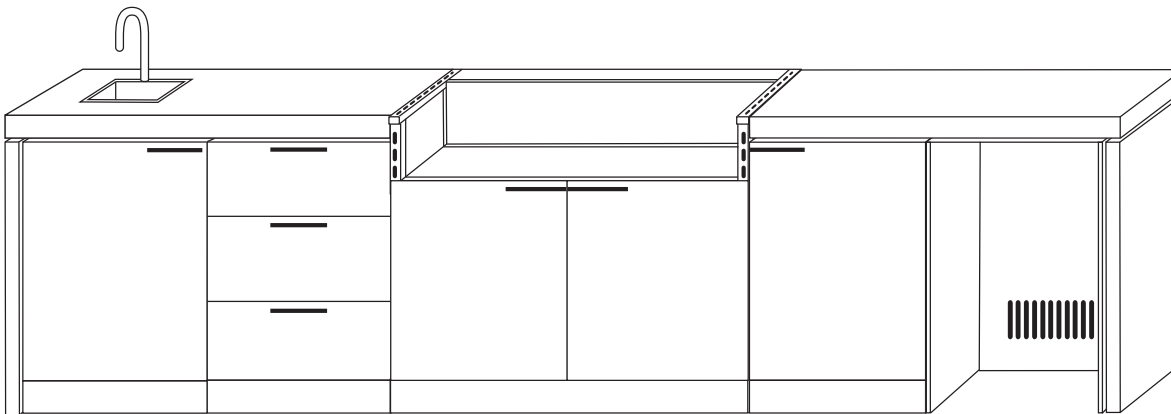

BBQ Module -  
1045mm

Premium Bar Fridge  
SC-108FS (SC-108F)



### OPTIONAL ACCESSORY

Front View

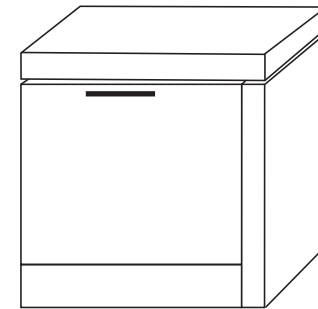

Kamado Joe Module

# PREMIUM SERIES

## BEEFEATER Proline 6 Burner Premium Outdoor Kitchen



Front View

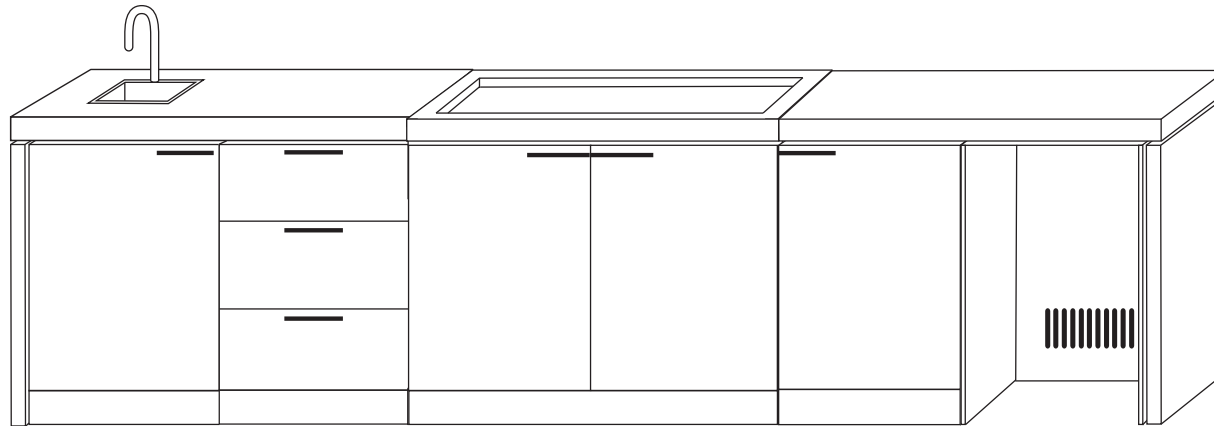

▲  
BBQ Module -  
1165mm

▲  
Premium Bar Fridge  
SC-108FS (SC-108F)

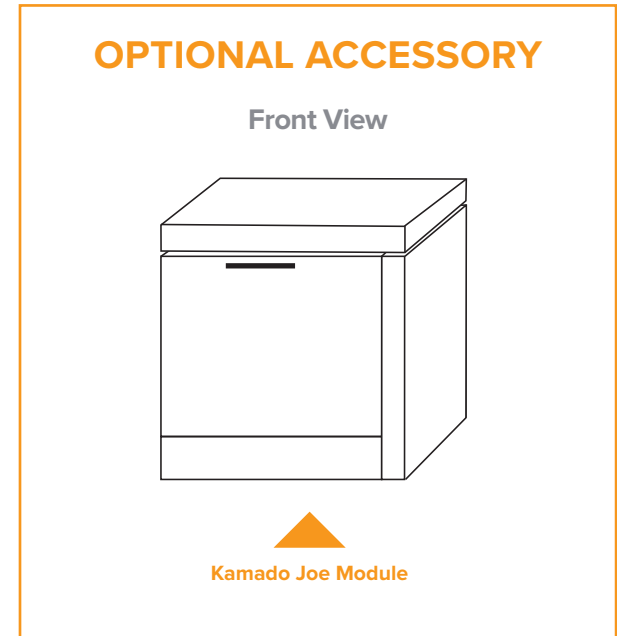



# PREMIUM SERIES Modules

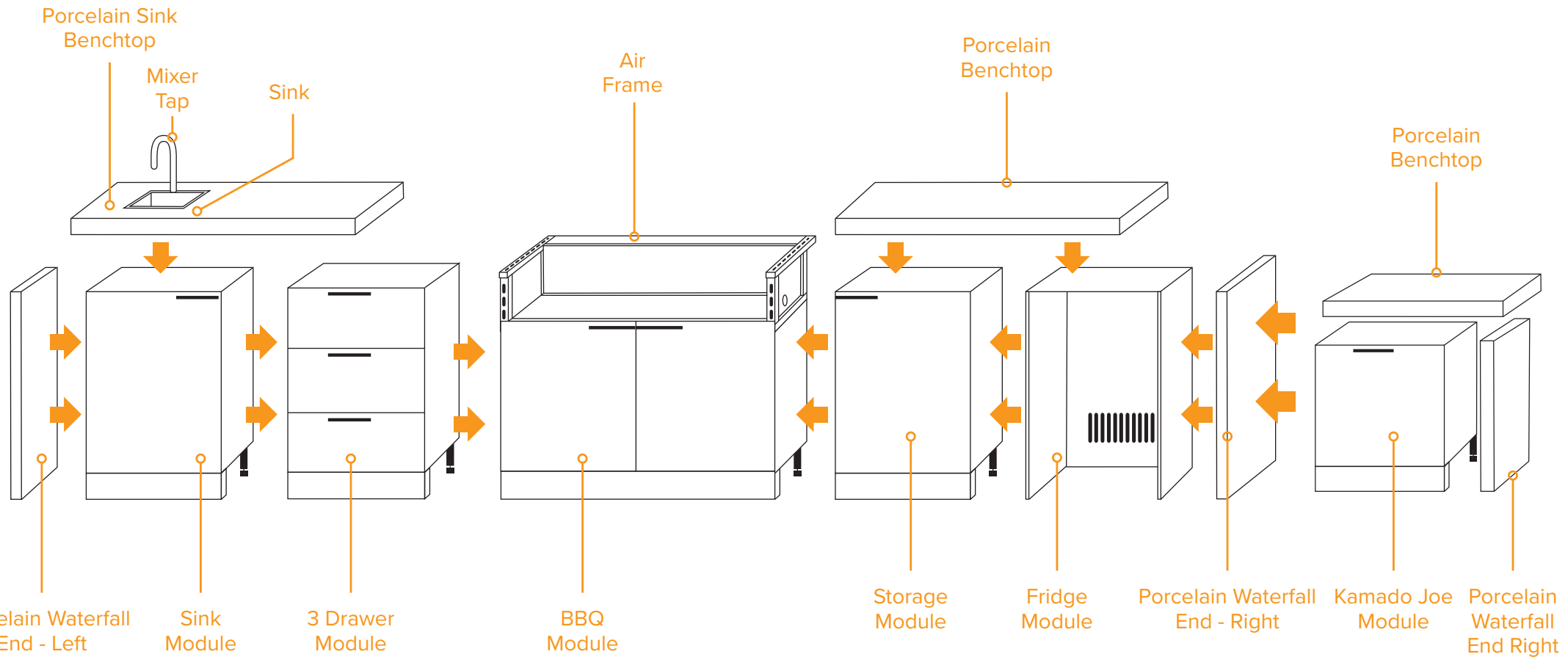

# PREMIUM SERIES

## BBQ Modules and Air Frame

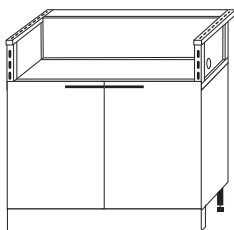

### BBQ Module & Air Frame - 885mm

- 885mm (W) x 670mm (D) x 570mm (H)
- 950mm total max height including adjustable feet and Air Frame
- Internal width of Air Frame: 825mm W
- BBQ: BEEFEATER 3000 Series 4 Burner
- COLOUR: Cadet Grey

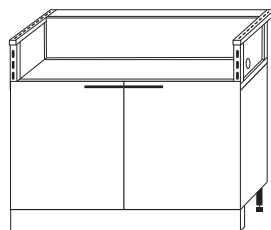

### BBQ Module & Air Frame - 1045mm

- 1045mm (W) x 670mm (D) x 570mm (H)
- 950mm total max height including adjustable feet and Air Frame
- Internal width of Air Frame: 985mm W
- BBQ: BEEFEATER 3000 Series 5 Burner
- COLOUR: Cadet Grey

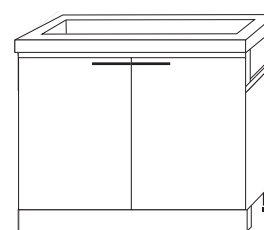

### BBQ Module - 1165mm

- 1165 (W) x 670 (D) x 770mm (H)
- 950mm total max height including adjustable feet and top
- BBQ: BEEFEATER Proline 6 Burner Flatlid and BEEFEATER Proline 6 Burner Roaster
- COLOUR: Cadet Grey

## Modules

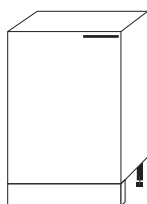

### Sink Module

- 550mm (W) x 670mm (D) x 770mm (H)
- 950mm total max height including adjustable feet and Top
- Top: 730mm deep to allow for services\* (see note below)
- COLOUR: Cadet Grey

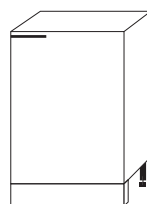

### Storage Module

- 550mm (W) x 670mm (D) x 770mm (H)
- 950mm total max height including adjustable feet and Top
- Top: 730mm deep to allow for services\* (see note below)
- COLOUR: Cadet Grey

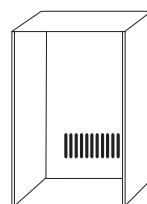

### Fridge Module

- 550mm (W) x 670mm (D) x 770mm (H)
- 950mm total max height including adjustable feet and Top
- Top: 730mm deep to allow for services\* (see note below)

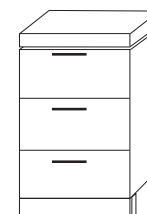

### 3 Drawer Module

- 550mm (W) x 670mm (D) x 770mm (H)
- 950mm total max height including adjustable feet and Top
- Top: 730mm deep to allow for services\* (see note below)
- COLOUR: Cadet Grey

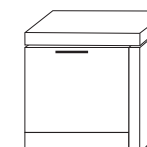

### Kamado Joe Module

- 610 (W) x 730 (D) x 425mm (H)
- 545mm total max height including adjustable feet and top
- Top 730mm to match other modules
- COLOUR: Cadet Grey

\*NOTE: Benchtops are deeper than the cabinets to allow for services (hot and cold plumbing, electrical cords and drainage) to run behind the outdoor kitchen when assembled. The legs on each module are designed to be adjusted for levelling.

# PREMIUM SERIES

## Porcelain Benchtops

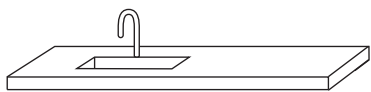

### Benchtop to suit Sink Module - 610mm

- 1160mm (W) x 730mm (D) x 60mm (H)
- COLOUR: Porcelain Black



### Benchtop to suit Storage and Fridge Module - 1160mm

- 1160mm (W) x 730mm (D) x 60mm (H)
- COLOUR: Porcelain Black

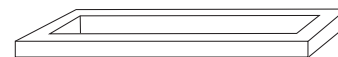

### Benchtop to suit BEEFEATER Proline 6 Burner BBQ Module

- 1165 (W) x 730mm (D) x 60mm (H)
- COLOUR: Porcelain Black

## End Panels



### Porcelain Waterfall End - Left

- 60mm (W) x 730mm (D) x 865mm (H)
- COLOUR: Porcelain Black



### Porcelain Waterfall End - Right

- 60mm (W) x 730mm (D) x 865mm (H)
- COLOUR: Porcelain Black

## Sink & Mixer Tap



### Sink Module

Sink to suit Sink Module. Matte Black sink is made from premium materials for a more robust finish and design.

- 490mm x 520mm x 200mm
- COLOUR: Matte Black finish



### Sink Module - Mixer Tap

Mixer Tap to suit Sink Module. Matte Black Mixer Tap gives your outdoor kitchen a modern, contemporary look and feel. The outdoor kitchen mixer tap is designed for full hands, the long spout enables you to use your elbow if you need to move the spout out of the way. The 360° swivel function makes this an efficient tap for your outdoor kitchen.

- COLOUR: Matte Black finish

## Planning and location of water, waste, power and gas services.

Preparing and checking the installation location is important to ensure the modular kitchen assembly and installation is as smooth as possible.

Ideally the floor surface should be level, clean and suitable for the cabinet installation along with water, waste, power and gas services, being able to be roughed in and compliant with all required with all required local government standards.

The services being roughed in should be left long enough to enable them to be fitted off inside the relevant cabinets after they have been installed.

*\*Note: All plumbing and electrical work must be done by a registered trades person.*



# CLASSIC & PREMIUM SERIES

Planning and location of water, waste, power and gas services.



FRONT VIEW

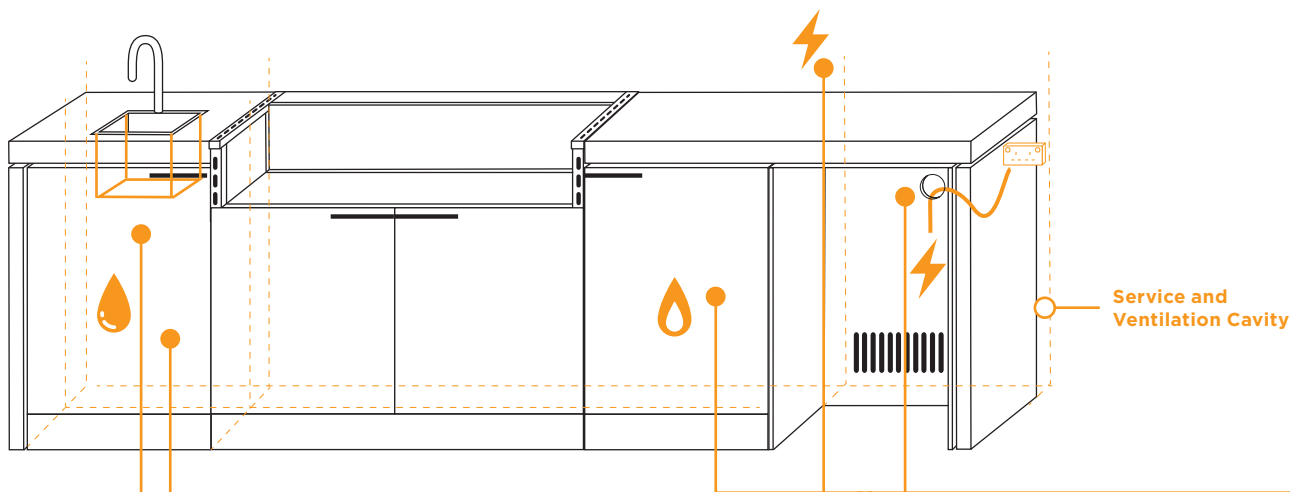

SIDE VIEW

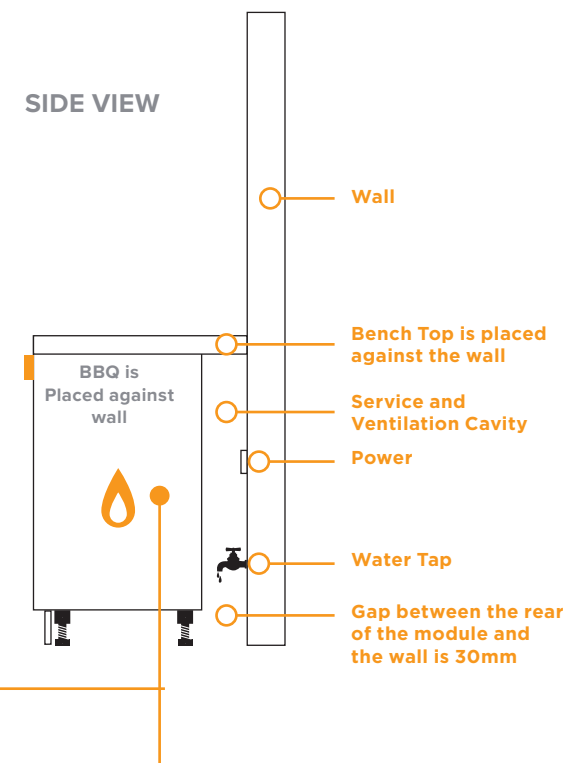

## HOT & COLD WATER

Ideally centralised in the Sink Cabinet

**650mm**

Above Floor Level

**200mm**

From Back Wall

## WASTE

This can be through the base or back of the Sink Cabinet

**300mm**

Above Floor Level

**350mm**

From Back Wall

PREMIUM SERIES will be wider

as it will included the single 3 drawer module

## ELECTRICAL - FRIDGE & APPLIANCE

The fridge requires 240V Power.

The preferred location for a power point to service the fridge is either mounted to a permanent wall behind the fridge module or in the cabinet module next to the fridge.

The preferred method is to have the power point in the cabinet module next to the fridge.

Cut a hole 50mm diameter in the fridge module to allow for plug access.

You may require power for a Rotisserie or other electrical appliance above your benchtop working surface.

## GAS CYLINDER LOCATION

Gas cylinder is to be positioned inside the storage module between the BBQ and Fridge Modules.

For any queries or assistance call:

**M Richards Ltd**

**PO Box 1238**

**Cheddar, UK**

**Tel: + 44 (0)1934 743322**

**Email: [sales@beefeater europe.co.uk](mailto:sales@beefeater europe.co.uk)**