

GARDEN WALL STORE - ASSEMBLY INSTRUCTIONS



IMPORTANT:
ASSEMBLY OF THIS
SHED REQUIRES TWO
PEOPLE

ISSUE 0210

SHOULD YOU REQUIRE ANY ADDITIONAL GUIDANCE WITH THE ASSEMBLY OF YOUR SHED PLEASE CONTACT OUR TECHNICAL HELP LINE ON 0844 248 9853.

Thank you for choosing this garden building manufactured by the UK's largest manufacturer of timber garden products. In order to gain the most benefit from it, please note the following:

- Exercise particular care and follow instructions whilst cutting the roofing felt. If it is cut incorrectly, additional roofing felt can be inexpensively purchased from most good DIY retailers or garden centres.
- Most buildings are pre-treated with a factory base coat for protection during storage and transit. We recommend that you treat your new building as soon as possible after assembly, using a wood preservative treatment. Apply in accordance with the manufacturers instructions.
- If there are any technical queries with the product, please contact our customer help line on 0844 248 9853 between the hours of 8.30 am and 5.00 pm Monday to Friday.
- Please ensure that you thoroughly check all component parts for quantity and quality before you commence building the product. If there are any missing parts, please contact the help line as shown immediately. The manufacturer cannot be held liable for damaged items once any part of the product has been fitted or altered in any way (e.g. Painted)
- Timber is a natural material. It will shrink and swell as a result of varying moisture content.
- Please keep all plastic bags and small parts away from children in order to reduce the risk of suffocation.

REQUIRED TOOLS : (NOT SUPPLIED)

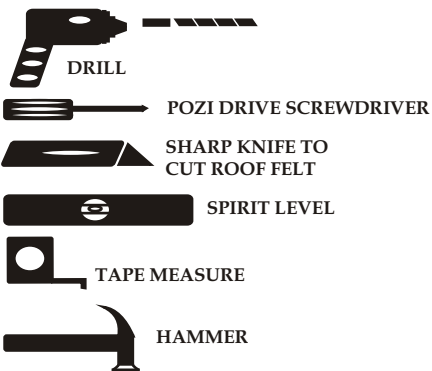

FIXING PACK (Fp01) CONTENTS :

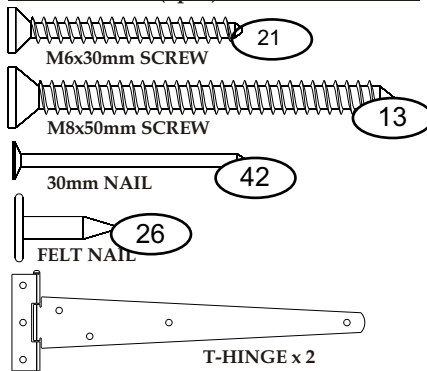

PLEASE NOTE: ALL SCREWS AND NAILS SHOWN BELOW AND IN INSTRUCTIONS ARE TO SCALE TO ASSIST IN IDENTIFICATION OF REQUIRED FIXINGS.

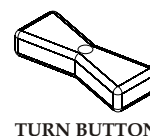

TURN BUTTON

FRONT PANEL x 1
(GSS10FRONTV2)

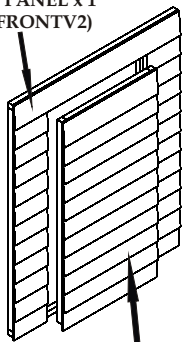

DOOR x 1 (GSS10DOORV2)

RH SIDE x 1 (GSS10RHSIDEV2)

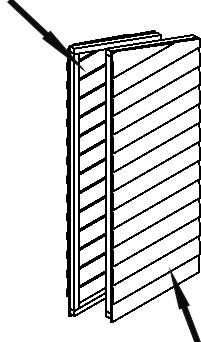

LH SIDE x 1
(GSS10LHSIDEV2)

OSB FOR BACK :
1456x1015mm QTY 1
(145610158)

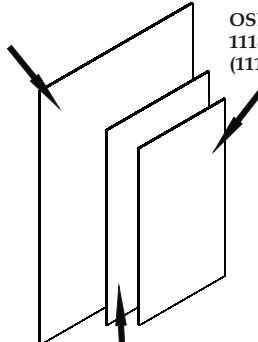

OSB FOR FLOOR :
1015x570mm QTY 1 (10155708)

FELT x 1 (85 008)



FIXING
PACK x 1

FLOOR BATTENS :
28x28x570mm QTY 3 (28280570PTR)

ROOF BATTENS :
28x28x1118mm QTY 1 (28281118)
28x28x650mm QTY 2 (28280650)

CORNER STRIPS :
45x15x1250mm QTY 2 (45151250DTR)

DOOR SLAMMING STRIP :
28x15x1120mm QTY 1 (28151120)

DOOR BATTEN
28x28x517 QTY 1 (28280517DTR)

1

PLACE THE THREE 28x28x570mm BATTENS (28280570PTR) ONTO THE GROUND SO THAT ENDS ARE FLUSH, AND THERE IS A 465mm GAP BETWEEN EACH ONE. PLACE 1015x570mm SHEET OF OSB (10155708) ON TOP OF THE BATTENS. SECURE SHEET OF OSB TO EACH BATTEN WITH THREE 30mm NAILS PLACED AS SHOWN ABOVE. IT IS VITAL THAT THE NAILS LOCATE INTO THE BATTENS.

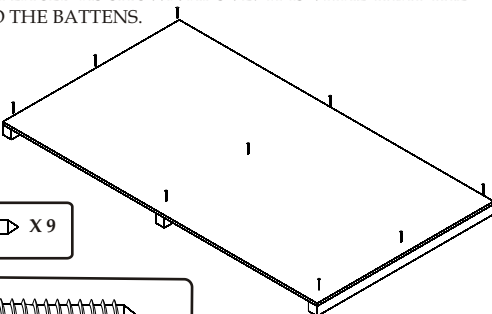
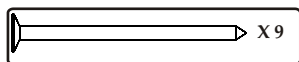

FIX THE 28280517DTR (BATTEN) TO THE BACK OF THE GSS10DOORV2 (DOOR) 130mm FROM THE TOP BATTEN, USING 2x50mm SCREWS AS SHOWN.

(THIS BATTEN IS FOR THE PLACEMENT OF THE TOP HINGE IN STEP 2)

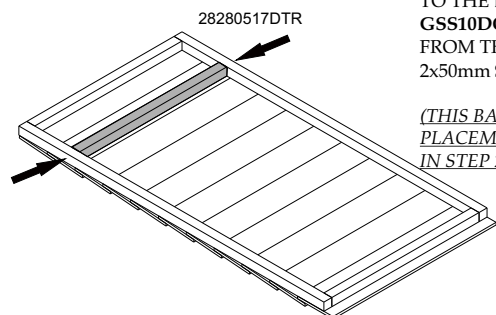

2

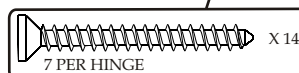
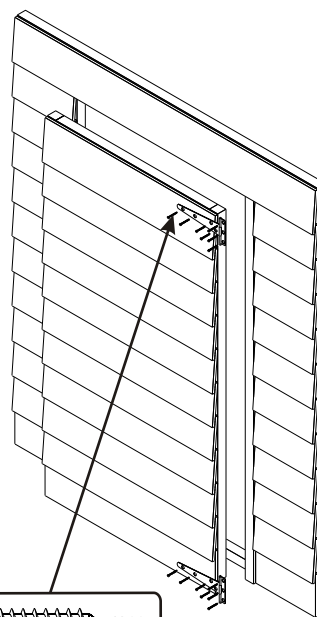

A) FASTEN EACH OF THE TWO HINGES TO THE RIGHT HAND SIDE OF THE DOOR (GSS10DOORV2) USING 30mm SCREWS. SCREWS MUST SECURE INTO THE TWO LOWER HORIZONTAL BRACES ON THE BACK OF THE DOOR.
B) LAY FRONT SECTION FACE UP ON GROUND. POSITION DOOR ON FRONT SECTION (GSS10FRONTV2) OF UNIT ENSURING THAT THE DOOR IS SQUARE WITH EQUAL GAPS TO LEFT AND RIGHT. SECURE HINGE TO FRONT SECTION WITH 30mm SCREWS.

3

POSITION THE COMPLETED (GSS10FRONTV2) FRONT PANEL ONTO THE FLOOR SO THAT THE LEFT AND RIGHT HAND EDGES OF THE PANEL ARE FLUSH WITH THE EDGES OF THE FLOOR. PLACE ONE OF THE SIDE PANELS (GSS10RHSIDE AND GSS10LHSIDE) ONTO THE FLOOR AND PLACE UP AGAINST THE FRONT PANEL. **(PLEASE NOTE THAT THE LOWER EDGES OF THE SIDE PANEL MUST BE AGAINST THE FRONT PANEL.)** SECURE THROUGH SIDE PANEL INTO THE FRONT USING 3x50mm SCREWS PLACED AS SHOWN TO ABOVE. **DO NOT SECURE THE PANEL TO THE FLOOR AT THIS POINT.** ONCE SECURE, PLACE AND SECURE THE REMAINING SIDE SECTION IN THE SAME MANNER. ATTACH THE 1120mm (28151120) SLAMMING STRIP TO THE FRAME WORK OF THE FRONT WITH 3x30mm NAILS. THE (28151120) SLAMMING STRIP SHOULD OVERHANG THE INSIDE EDGE OF THE DOOR FRAME WORK BY APPROXIMATELY 14mm

4

SECURE TWO SIDE SECTIONS AND FRONT SECTION TO FLOOR WITH TWO 50mm SCREWS PER SIDE AND ONE AT FRONT (50mm SCREW AT FRONT MUST LOCATE INTO CENTRAL FLOOR BEARER).

5

PLACE 1456x1015mm SHEET OF OSB (145610158) AGAINST BACK OF UNIT WITH LEFT AND RIGHT HAND EDGES FLUSH WITH OUTER FLOOR BEARERS AND BOTTOM EDGE FLUSH BOTTOM OF FLOOR OSB. SECURE IN PLACE WITH 6x30mm NAILS DOWN THE LEFT AND RIGHT SIDES AND 1x 30mm NAIL PLACED CENTRALLY AT THE BOTTOM. SECURE (28151120) CORNER STRIP TO EACH FRONT CORNER OF THE UNIT WITH 3x30mm NAILS.

6

LAY THE 28x28x1118mm BATTEN (28281118) AND THE TWO 28x28x650mm BATTENS (28280650) FLAT ON THE GROUND. ENDS OF 650mm BATTENS MUST BUTT UP AGAINST SIDE OF 1118mm BATTEN. LAY 1118x678mm SHEET OF OSB (11186788) ON TOP OF BATTENS AND SECURE THROUGH SHEET OF OSB INTO EACH 650mm BATTEN WITH THREE 30mm NAILS, AND THE 1118mm BATTEN WITH FIVE 30mm NAILS. THIS IS THE ROOF SECTION.

7

PLACE ASSEMBLED ROOF SECTION ONTO THE UNIT. ENSURE EQUAL OVERHANG TO LEFT AND RIGHT SIDES. BACK OF ROOF SHOULD BE FLUSH WITH OSB ON BACK OF UNIT. SECURE THROUGH ROOF OSB INTO TOP FRAMEWORK OF LEFT AND RIGHT HAND SIDES WITH THREE 30mm SCREWS.

8

OPEN ROOFING FELT AND ROLL OUT FLAT ON GROUND.

WHEN FELT HAS FLATTENED PLACE IT ON THE ROOF SO THAT IT OVERLAPS EQUAL AMOUNTS AT THE LEFT AND RIGHT HAND SIDE OF THE SHED, AND BY APPROXIMATELY 40mm AT THE FRONT OF THE ROOF. SECURE FELT WITH FELT NAILS PLACED AT 150mm INTERVALS ALONG THE OUTER EDGES OF THE ROOF. CUT AND FOLD FELT AT CORNERS AND SECURE FOLD WITH A FELT NAIL. FOLD FELT OVER BACK OF UNIT AS SHOWN ABOVE AND SECURE TO OSB BACK WITH FELT NAILS PLACED AT 150mm INTERVALS.

9

ATTACH TURN BUTTON TO UNIT WITH ONE 30mm SCREW. SCREW MUST LOCATE INTO FRAMEWORK OF UNIT FRONT AND BE POSITIONED SO THAT IT WILL HOLD DOOR CLOSED.